

2026

PHARMA SYSTEMS

**NEW
PRODUCTS**
PAGE 6

**CUSTOM LABELS,
YOUR WAY**
PAGE 153

**CONNECT WITH
CONFIDENCE**
ENFIT SOLUTIONS INSIDE
PAGE 96

**SUPPLIES
YOU
CAN
COUNT
ON**

 **PharmaSystems®**

THE RX COLLECTION

ORDER FORM

ITEM #	DESCRIPTION	QUANTITY

DOWNLOAD THE FORM HERE

PHARMACY NAME:		CONTACT NAME:	
ADDRESS:		PHONE:	
CITY:		FAX:	
PROVINCE:	POSTAL CODE:	EMAIL:	
DATE:	WHOLESALER:	ACCOUNT NO.:	

Please email or fax the completed order form to us.

orders@pharmasystems.com

fax: 1.888.475.7155

Please note: Shipping charges will be added to each order

 **PharmaSystems®**

pharmasystems.com

Contents

06 New Products

08 Compounding & Dispensing Accessories

08 Scales

11 Cylinders

17 Filter Paper

22 Methadone Supplies

28 Vials

31 Bottles

33 Tablet Counters

35 Boxes & Bins

35 AcroBins

40 Cassettes

43 Totes

48 Caddies

52 Drug Boxes

53 Security Seals

53 Pull Tight Security Seals

57 Tamper Evident Seals

60 Tamper Resistant Tape

61 Syringe Seals

64 Narcotic Cabinets

68 Poly Bags

68 Zip It Bags

69 Resealable Bags

70 Non Reclosable Bags

71 Crusher Pouches

72 UV Bags

75 Security Bags

78 Hanging Prescription Bags

79 Biohazard Waste Bags

83 Medication Delivery Systems

83 KwikDose Oral Dispenser

85 Bottle Adapters

88 Adapter Caps

90 Needles

92 Kwik Vial Accessories

95 ENFit Enteral Feeding Supplies

97 Unit Dose Solutions

98 Class A Labels & Blisters

102 Class B Labels & Blisters

104 Ointment Labels & Blisters

106 Pharmacy Supplies

106 Mats

108 Kango Chairs

110 Prescription Labels & Bags

112 Rx Tape & Dispensers

114 Pill Crushers & Accessories

117 Crushers & Cups

119 Carts & Accessories

119 Utility Carts

121 Stainless Steel Carts

122 Crash Cart Boxes

124 Crash Cart Bags

126 Temperature Monitoring & Storage

126 Requirements & Recommendations

128 Refrigerator & Freezer Thermometers

132 Refrigeration

133 Storage Accessories

137 Labels & Labeling Tape

138 Label Dispensers

151 Patient Privacy Labels

153 Labeling Tape

154 Custom Label Order Form

156 Protective Apparel & Infection Control

156 Sharps Containers

158 Biohazard Bags

160 Spill Kits

161 Gloves & Gowns

162 PPE Organization & Storage

165 Masks

166 Wipes

Order Forms

02 Blank Order Form

154 Custom Label

173 New Pharmacy Recommendations

174 Methadone Dispensing

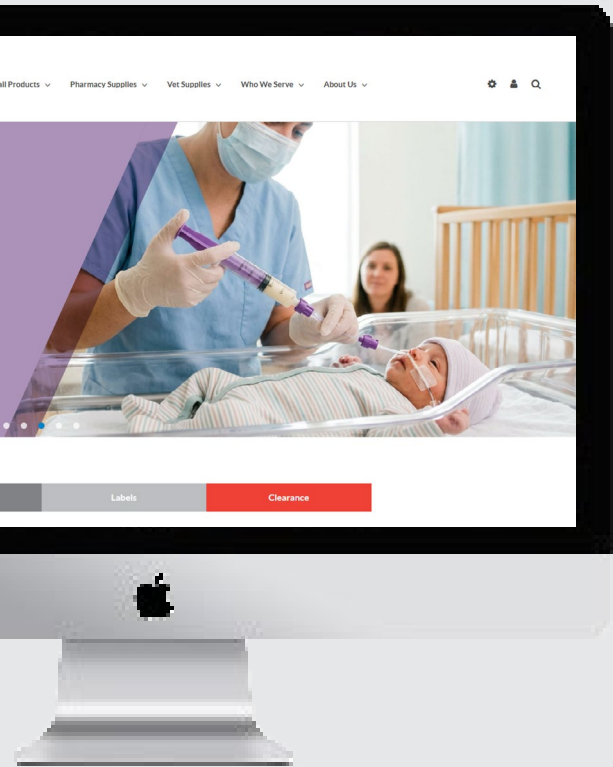

Register an account to place your order today!

- View pricing: Simply register your account
- Place orders online through our online shopping cart, or by downloading a blank order form (return by fax or email)
- See new products: Be the first to know about new products
- Save on deals & promotions: Learn about new product promotions and take advantage of deals & clearance sales
- Stay informed: Keep up to date with changing Canadian Pharmacy Regulations and learn about product recommendations. Look out for the 'New Pharmacy Recommendation' tab.



How to order:

Phone in your order: 905.475.2500 | Toll free: 1.888.475.2500

Fax in your order: 905.475.7155 | Toll free: 1.888.475.7155

Email your order: orders@pharmasystems.com

Use the order form found on page 1

Place your order online: www.pharmasystems.com

Our bilingual customer service team is readily available to help you with any of your pharmacy supply requests!

T: 905.475.2500 | Toll free: 1.888.475.2500

F: 905.475.7155 | Toll free: 1.888.475.7155

Address: 151 Telson Road Markham Ontario Canada L3R 1E7

Email: orders@pharmasystems.com | info@pharmasystems.com

Website: www.pharmasystems.com

Wholesalers: Most pharmacy products are available from your local drug wholesaler who may sell for more or less than the catalogue/website price. Drop ship prices are shown in the catalogue/website. Product not available from your wholesaler will be shipped from our warehouse facility in Markham, Ontario.

Shipping Terms: Orders will be shipped to all destinations in Canada. We reserve the privilege of shipping via the carrier of your choice.

Prices: Prices are subject to change without notice.

Terms: Net 30 days or as per your wholesaler

Returns: All returns to PharmaSystems must be authorized, and subject to a 25% restocking fee.

Accessibility: In meeting the needs of our customers and employees we strive at all times to provide our products in a way that respects the dignity of all individuals including persons with disabilities. In order to ensure equal treatment all PharmaSystems' customer service representatives and administrators are trained on policies, practices and procedures with respect to our commitment to people with disabilities.

Please Note: We have developed our Rx Supplies Catalogue to showcase our most requested supplies. Please refer to our website for our entire product catalogue and for the most up-to-date product information.

Stat Temp 3.0 NIST Certified Refrigerator / Freezer Sensor

- Encased Sensor - Sensor (21266 includes one sensor; 21268 includes two sensors) is housed inside an unbreakable silicone case that can be placed within the wires on most refrigerator and freezer shelves to minimize obstructions.
- Data Logging - Wi-Fi-enabled temperature monitor (included) offers unlimited readings with user-selected logging rate from every 5 minutes up to every 30 minutes.
- No Fees - There is no subscription fee for Stat Temp.
- Dimensions: 4"W x 2½"H x 1"D

View more details on page 138.

Item #	Description	Temperature Range	Temperature Accuracy
21266	Single Sensor	-50°C to 50°C (-58°F to 122°F)	+/-0.2°C
21268	Double Sensor	-50°C to 50°C (-58°F to 122°F)	+/-0.2°C
21270	Ambient Sensor	-40°C to 85°C (-40°F to 185°F)	+/-0.2°C
21272	Ultra-Low Sensor	-100°C to -50°C (-148°F to -58°F)	+/- 0.5°C



Pharmacy Prescription Labels

- Preprinted in yellow & pink
- Smudge-free topcoat for clarity and durability
- Includes space to print up to 5 auxiliary labels
- Fully compatible with Kroll, Fillware, PharmaClik, and PropelRx systems - contact us to learn more
- Fully compatible with desktop printers such as Zebra ZD and GK. Contact us for more information

Item #		Dimensions (W x H x D)	Quantity
80411	A	2" x 4.5"	500 labels per roll
80412	B	3.375" x 4.25"	900 labels per roll

Bag Caddy for Hanging Prescription Bags | 17545

- Bag caddy designed for use with hanging prescription bags
- Holds up to 40 hanging prescription bags
- Ideal for use in pharmacies, to organize bags to be reused
- Measures: 6"W x 16.5"H x 7"D



Acrylic Label Dispenser with Dividers | 12722

- Customizable Storage: Includes 6 removable dividers (3-3/4") so you can organize multiple label rolls and adjust spacing to fit your needs
- Clear Acrylic Design: Transparent construction lets you quickly see labels, sizes and colours at a glance
- Keeps Labels Neat & Accessible: Prevents rolls from unraveling, tangling, or getting misplaced
- Streamlines Workflow: Speeds up labeling with quick one-hand access
- Professional Display Look: Clean, modern design elevates any workspace or counter
- Dimensions: 34.5 x 9 x 18 cm

Breeze Break draft shield prevents air drifts caused by surrounding environmental movements - used to retain a constant mass reading!



EJ Series Electronic Scales

- Select from 3 decimal place display (VIC-123, VIC-303) or 2 decimal display (EJ200, EJ410, EJ610)
- Measures by weight, percentage, counting, and density functions
- Sample key available for easy parts counting, percentage and totals
- Outputs weight data, GLP report and calibration report to printer or computer (additional accessories are required, contact us for details)
- Full digital calibration – calibration weight not included (See item #CAL100/CAL200)
- Easy levelling – adjust 4 feet

Specifications

Weighing Pan	110 mm (round)
Sensitivity Drift	± 20 ppm/ °C (10-30°C)
Min. % Display	0.1%
Display	7 segment LCD with backlight
Display Update	10 times per second
Operating Temperature	-10°C - 40°C, less than 85% R.H.
Power Supply	AC adapter (included) or 4 x “AA” size dry-cell batteries (70 hours of battery life)
Weight	850 g
Warranty	5 years

Item #	Description	Weight Capacity	Minimum Display	Accuracy	Weighing Pan Size
VIC-123	A Compact Balance with Lid	120 g	0.001 g	±0.001 g	110 mm
EJ200	B Compact Precision Balance	210 g	0.01 g	±0.01 g	110 mm
EJ200C	Compact Precision Balance with Lid	210 g	0.01 g	±0.01 g	110 mm
VIC-303	Compact High Precision Balance with Lid	310 g	0.001 g	±0.001 g	110 mm
EJ410	Compact Balance	410 g	0.01 g	±0.01 g	110 mm
EJ610	Compact Precision Balance	610 g	0.01 g	±0.01 g	110 mm
EJ-11	C Breeze Break for use with EJ Series Balances	-	-	-	-

A&D Precision Top Loading Balance

- Fast stabilization speed (1 second)
- Large bright vacuum florescent display
- Shock absorber function
- Statistical calculation function multiple weighing units
- Digital calibration function
- Counting function with ACAI (Automatic Counting Accuracy Improvement)
- Operating temperature - 5°C to 40°C (41°F to 104°F), 85% RH or less (No condensation)

Item #	Weight Capacity	Minimum Display	Accuracy	Weighing Pan Size
FX-300i A	320g	0.001g	±0.001g	130 mm
FX-3000i B	3200g	0.01g	±0.001g	150 mm
FZ-300i	320g	0.001g	±0.001g	130 mm



Calibration Weights

- For calibration of electronic balance scales
- Recommended for use with scales to meet the requirements of the College of Pharmacists
- **Contact us for details on additional weights and scales that meet ASTM standards**

Item #	Description
CAL100 C	100g Calibration Weight
CAL100GS	100g with Certificate of Accuracy
CAL200	200g Calibration Weight
CAL200GS	200g with Certificate of Accuracy

Apothecary Weight Set

- Uniform density
- Low magnetic properties
- High resistance to wear and corrosion
- Includes: 10, 20, 50, 100, 200, 500 mg aluminum weights; ½, 1, 2, 3, 4, 5, grain aluminum links; 1, 2, 5, 10, 50 g.; 1, 2 oz., ½, 1 and dram, ½, 1 and 2 scruple brass weights; and tweezers

Item #	
4027 D	



Octagonal Stir Bars

- PTFE coated
- Features ALNICO V magnetic cores (Store in pairs to maintain magnetic strength, away from scales)

Item #	Size	Length	Diameter
86301	Small	1"	5/16"
86315	Medium	1.5"	5/16"
86302	Large	2"	5/16"

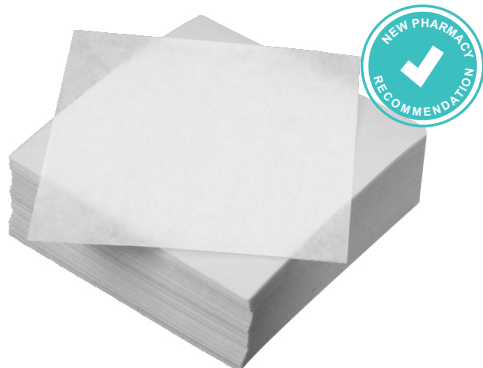
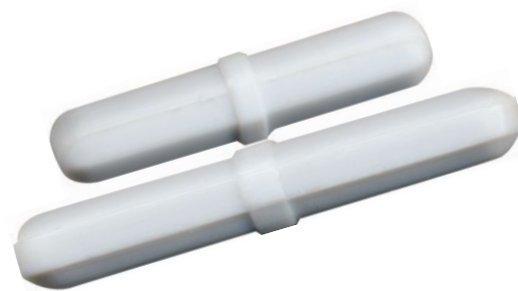

Paper Glassine Polished

- Non-absorbent glassine weighing paper
- 500 per package

Item #	Size
3410	3" square
3016	4" square
3412	6" square
68415	6" square

Plastic Weighing Boats

- Inexpensive, disposable containers
- Ideal for weighing quantities of ingredients
- Resilient, polystyrene construction ensures accurate control of pour-outs after weighing
- Non-stick surface is rugged enough for mixing
- Designed to easily stack and nest

Item #	Size	Dimensions	Qty
3420	Micro	4.4 x 4.4 cm	100
40100	Small	4.5 x 4.5 cm	100
3090	Medium	8.3 x 8.3 cm	100
3092	Large	14 x 14 cm	100



Anti-Static Weighing Canoes

- Provides anti-static surface for weighing ingredients
- Unique canoe shape enables easy pouring
- Made of virgin polystyrene with 10 to 9 OHM/square resistivity, the ideal dissipative range (the property of anti-static)
- Non-stick surface is rugged enough for mixing
- 100 per package

Item #	Size	Dimensions (inches)
3421	Small	1.8 x 2.2 x 5
3422	Medium	3.25 x 5.28 x 1
3423	Large	4.25 x 7 x 1.17

Class A Graduated Cylinders

- High-quality autoclavable borosilicate glass cylinders
- Hexagonal base with 3 dimples for added stability
- White enamel graduations applied by laser, heat annealed, and inspected with code number to ensure accuracy
- Volume accuracy calibrated to contain (TC)
- Includes polyethylene hexagonal bumper guard (with the exception of the 5mL & 2000 mL size)
- Meets ASTM E-1272 Class A, Style I Specifications & USP Standards for Volumetric Glassware
- *Recommended for methadone dispensing

Item #	Volume	Increments	Accuracy	Scales
1634AA-5	5 mL	0.1 mL	±0.05 mL	Single
1634AA-10	10 mL	0.1 mL	±0.05 mL	Single
1634AA-25	25 mL	0.2 mL	±0.15 mL	Single
1634AA-50	50 mL	0.5 mL	±0.25 mL	Double
1634AA-100 A	100 mL	1 mL	±0.4 mL	Double
1634AA-250*	250 mL	2 mL	±1 mL	Double
1634AA-500	500 mL	5 mL	±2 mL	Double
1634AA-1000	1000 mL	10 mL	±3 mL	Double
1634AA-2000	2000 mL	20 mL	±6 mL	Double

Class B Graduated Cylinders

- High-quality autoclavable borosilicate glass cylinders
- Detachable hexagonal sturdy base absorbs impact
- Includes protective hexagonal bumper guards
- White enamel graduations, applied by machine, heat annealed
- Volume accuracy calibrated to contain (TC)
- Meets ASTM E-1272 Class B, Style I Specifications

Item #	Volume	Increments	Accuracy	Scales
CYGPB-10	10 mL	0.1 mL	±0.1 mL	Single
CYGPB-25	25 mL	0.2 mL	±0.3 mL	Single
CYGPB-50	50 mL	0.4 mL	±0.4 mL	Double
CYGPB-100 B	100 mL	1 mL	±0.6 mL	Double

Made from high-quality autoclavable borosilicate glass cylinders & the volume accuracy is calibrated to contain (TC)

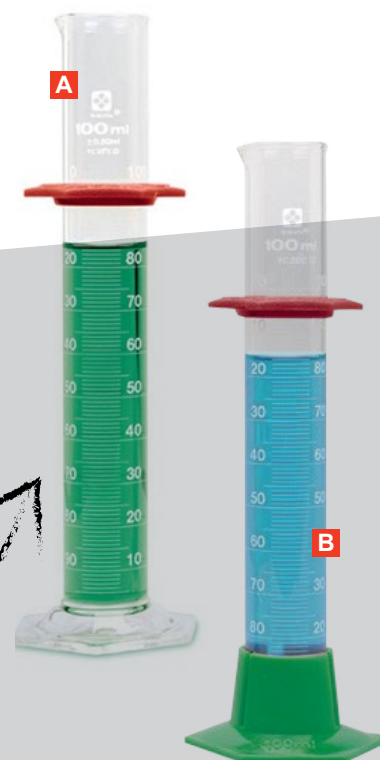



Bell & Conical Glass Cylinders

- Bell and conical shaped glass graduated cylinders, with easy-pour spouts
- Bell shape has a controlled diameter – recommend for accuracy
- Bell-shaped cylinders have single scale white enamel graduations, manually applied and annealed for accuracy
- Conical-shaped cylinders have single scale molded graduations
- Volume accuracy calibrated to contain (TC)
- Flint conical glass cylinders cannot be autoclaved

Item #	Volume	Shape	Material	Increments
3360	5 mL	Bell	Borosilicate	1 mL
3361	10 mL	Bell	Borosilicate	0.5 mL
3362	25 mL	Bell	Borosilicate	1 mL
3019	50 mL	Conical	Flint	5 mL
3021	100 mL	Conical	Flint	5 – 25 mL
3022	250 mL	Conical	Flint	10 – 50 mL
3023	A 500 mL	Conical	Flint	25 – 50 mL
3363	B 1000 mL	Bell	Borosilicate	20 mL

Glass Cylinders

- High-quality autoclavable borosilicate glass
- White enamel graduations, applied by machine, heat annealed
- Volume accuracy calibrated to contain (TC)
- Round base
- Meets Class B specifications

Item #	Volume	Increments	Scales
3002	10 mL	0.2 mL	Single
3009	25 mL	0.5 mL	Single
3006	50 mL	1 mL	Single
3008	100 mL	1 mL	Single
3014	C 250 mL	2 mL	Single
3015	500 mL	5 mL	Single
3371	1000 mL	10 mL	Single

Clear Plastic Graduated Cylinders

- Polymethylpentene (TPX) plastic cylinders are highly resistant to chemical attack (at room temperature)
- Sturdy hexagonal base
- Clear plastic with molded graduations
- Can be sterilized by autoclaving (120°C), gas, and radiation – not autoclavable by dry heat
- Can hold a maximum temperature of 175°C
- Volumes calibrated to deliver (TD)

Item #	Volume	Increments	Accuracy	Scales
3040	10 mL	0.2 mL	±0.2 mL	Single
3435	25 mL	0.5 mL	±0.5 mL	Single
3045	50 mL	1 mL	±1 mL	Single
3046	100 mL	1 mL	±1 mL	Single
3047 A	250 mL	2 mL	±2 mL	Single
3048	500 mL	5 mL	±5 mL	Single
3436	1000 mL	10 mL	±10 mL	Single
3437	2000 mL	20 mL	±20 mL	Single

Plastic Graduated Cylinders

- Polypropylene cylinders are very resistant to effects of Alkalies
- Sturdy hexagonal base
- Can be sterilized by autoclaving (120°C), gas, and radiation – not autoclavable by dry heat
- Can hold a maximum temperature of 135°C
- Volumes calibrated to deliver (TD)

Item #	Volume	Increments	Accuracy	Scales
3431	10 mL	0.2 mL	±0.2 mL	Single
3034	50 mL	1 mL	±1 mL	Single
3036	100 mL	1 mL	±1 mL	Single
3037 B	250 mL	2 mL	±2 mL	Single
3038	500 mL	5 mL	±5 mL	Single
3439	2000 mL	20 mL	±20 mL	Single

Cylinder Brushes

- Use to clean cylinders, graduates and bottles
- Sturdy wire handled brush with nylon bristles and tufted end for thorough cleaning
- Size includes handle

Item #	Description	Size
3049 C	Small - For 50 mL Cylinders	11" (229 mm)
3059	Medium - For 100-200 mL Cylinders	13" (330 mm)
3066	Large - For 500 mL Cylinders	17" (438 mm)



Pitchers

- Transparent polypropylene plastic
- Handles for convenient lifting
- Autoclavable and chemically resistant
- Raised graduations

Item #	Volume	Increments
PIP-500	500 mL	5 mL
PIP-1L	1000 mL	10 mL
PIP-2L	2000 mL	50 mL
40055	3000 mL	100 mL
PIP-5L	5000 mL	250 mL



Glass Beakers

- Low-form Griffin borosilicate glass beaker with white enamel single scale
- graduations, applied by laser and heat annealed
- Shape and heavy wall construction offers optimum strength
- Spout for easy pouring
- Ideal for mixing and heating materials

Item #	Volume	Increments
3372	30 mL	10 mL
3024	50 mL	10 mL
3025	100 mL	10 mL
3373	150 mL	25 mL
3026	250 mL	25 mL
3374	400 mL	25 mL
3027	600 mL	50 mL
3375	1000 mL	50 mL

Stainless Steel Beakers

- Durable, seamless construction, with easy-pour rim
- Will not break, leach product, or become marred inside
- Non-corrosive and rust resistant

Item	Description
18602	600 mL
18604	2000 mL, with handle
18603	4000 mL, with handle



Clear Plastic Beakers

- Polymethylpentene (TPX) is highly resistant to chemical attack (at room temperature)
- Can be sterilized by autoclaving (120°C), gas, and radiation – not autoclavable by dry heat
- Molded graduations

Item #	Volume	Increments
BKTPX-50	50 mL	2 mL
BKTPX-100	100 mL	5 mL
BKTPX-250	250 mL	10 mL
BKTPX-600	600 mL	10 mL
BKTPX-1L	1000 mL	20 mL
BKTPX-2L	2000 mL	50 mL



Plastic Beakers

- Graduations are molded in milliliters
- Polypropylene beakers are very resistant to effects of Alkalies
- Can be sterilized by autoclaving (120°C), gas, and radiation – not autoclavable by dry heat

Item #	Volume	Increments
BKP-50	50 mL	2 mL
BKP-100	100 mL	5 mL
BKP-250	250 mL	10 mL
BKP-600	600 mL	10 mL
BKP-1L	1000 mL	20 mL
BKP-2L	2000 mL	50 mL
BKP-5L	5000 mL	500 mL



Glass Stirring Rods

- Soft glass with rounded ends minimizes scratching

Item	Size	Qty
3017	8"	3
3018	10"	3

Plastic Stirring Rods

- White polypropylene plastic
- Small and large spatulas form at each end

Item #	Size
39160	9.63" (24.5 cm) long

Stir Bar Retriever

- Ideal for use with stirring rods (see above)
- Encased in chemically resistant polypropylene
- Hand ring allows for hanging when not in use

Item #	Description
86398	18 inches (45.72 cm) long



Erlenmeyer Flasks

- White permanent graduations and large marking squares
- Made from high-quality borosilicate tubing with a low coefficient of expansion
- Volumes calibrated to deliver (TD)
- Meets ASTM E-1404 Type I, Class 1 specifications

Item #	Volume	Increments
24-125	125 mL	25 mL
24-250	250 mL	50 mL
24-500	500 mL	100 mL
24-1L	1000 mL	100 mL
24-2L	2000 mL	250 mL
24-5L	5000 mL	500 mL



Volumetric Flasks

- Class A volumetric flask, calibrated to contain (TC) with fitted polyethylene stopper
- Borosilicate tubing provides uniform wall thickness resulting in optimum balance between thermal shock resistance and mechanical strength
- White enamel graduations

Item #	Volume	Accuracy
2415-10	10 mL	±0.02 mL
2415-25	25 mL	±0.03 mL
2415-50	50 mL	±0.05 mL
2415-100	100 mL	±0.1 mL
2415-200	200 mL	±0.15 mL
2415-250	250 mL	±0.15 mL
2415-500	500 mL	±0.25 mL
2415-1000	1000 mL	±0.4 mL
2415-2000	2000 mL	±0.6 mL

Plastic Funnels

- Lightweight polypropylene
- Durable, long stem design

Item #	Diameter	Capacity
3030	55 mm	55 mL
3031	100 mm	100 mL

Heavy Duty Glass Funnels

- Ribbed on inner surface to increase flow

Item #	Diameter	Capacity
3061	7 cm	60 mL
3063	9 cm	125 mL
3065	11-1/2 cm	250 mL
35695-04	14-1/2 cm	500 mL
35695-05	14-1/2 cm	100 mL





Filter Paper

- Use for filtration of coarse particles and gelatinous precipitates
- Standard qualitative filter papers suitable for quadrant fold or gravity flow applications
- Contains high level of alpha-cellulose that provides high purity, weakens when wet

Item #	Diameter	Grade	Particle Retention	Flow Rate	Speed	Rapidity	Qty
2994	110 mm	04	10 µm	Medium	34	200 mls/min	100
2995	75 mm	04	10 µm	Medium	34	200 mls/min	100
2998	110 mm	01	2.5 µm	Medium	124	55 mls/min	100
2999	185 mm	01	2.5 µm	Medium	124	55 mls/min	100
2996	240 mm	01	2.5 µm	Medium	124	55 mls/min	100
2997	320 mm	01	2.5 µm	Medium	124	55 mls/min	100

pH Test Papers

Item # 90710

- 1-14 pH range test papers
- Supplied in a clear plastic vial container
- Includes colour guides in vial
- 100 test strips per vial
- Each test strip measures 3 x 12 mm

Item # 6080

- 6-8 pH range
- Double roll, hydron pH test paper:
- Includes double roll dispenser
- Includes pH colour charts

Item #	Description
90710 A	1-14 pH range, 100 per vial
6080 B	6-8 (neutral) pH range, double roll with dispenser



Instructions for use of the test strip (item # 90710):

1. Use first morning urine
2. After a steady stream has started, wet the strip pad for 1-2 seconds
3. Gently shake off any excess fluid on the test strip and wait for 10-15 seconds
4. Compare/match the color of the test strip to the colour chart provided in the bottle. The number that corresponds to the color matched pad is the result.

The normal pH of urine is slightly acidic and gives a reading between 6.5-7.5. If the urine is on the alkaline side, the readings should correspond to colors indicating 7.5 or higher. Acidic urine gives color corresponding to 6.5 or lower. Please note that pH of urine is affected by the food and medication intake.



Rubber Spatulas

- Hard, non-porous rubber spatula for compounding
- Recommended for use with compounds that react with metal
- Can be cleaned with soap and water, alcohol or by autoclaving

Item #		Blade Size
3091	A	4" (101.6 mm)
3093		6" (152.4 mm)
3095		8" (203.2 mm)

Spatula with Multi-Purpose Tool

- Includes swing-out multi-purpose cutting tool
- Tapered end ideal for use when counting tablets
- Blade and cutting tool are made of stainless steel, handle is made of rosewood
- Cutting tool measures 1¼"

Item #	
1137	B

Stainless Steel Spatulas

- Flexible, dull curved edged, with a comfortable wood handle
- 4", 6" and 8" spatulas are recommended to meet the requirements of the College of Pharmacists

Item #		Blade Size
3042		4" (101.6 mm)
3043		5" (114.3 mm)
3028	C	6" (152.4 mm)
3029		8" (203.2 mm)
3429		10" (254 mm)
3430		12" (355.6 mm)

Disposable Spatulas

- Unique hollow cores minimize thermal transfer
- Resistant to dilute acids and bases
- Autoclavable polypropylene can be used for sterile compounding

Item #		Description	Size	Qty
17946	D	Disposable, Opaque	210mm	300
17947	E	Disposable, Blue	210mm	300
17948	F	Disposable, Green	310mm	150

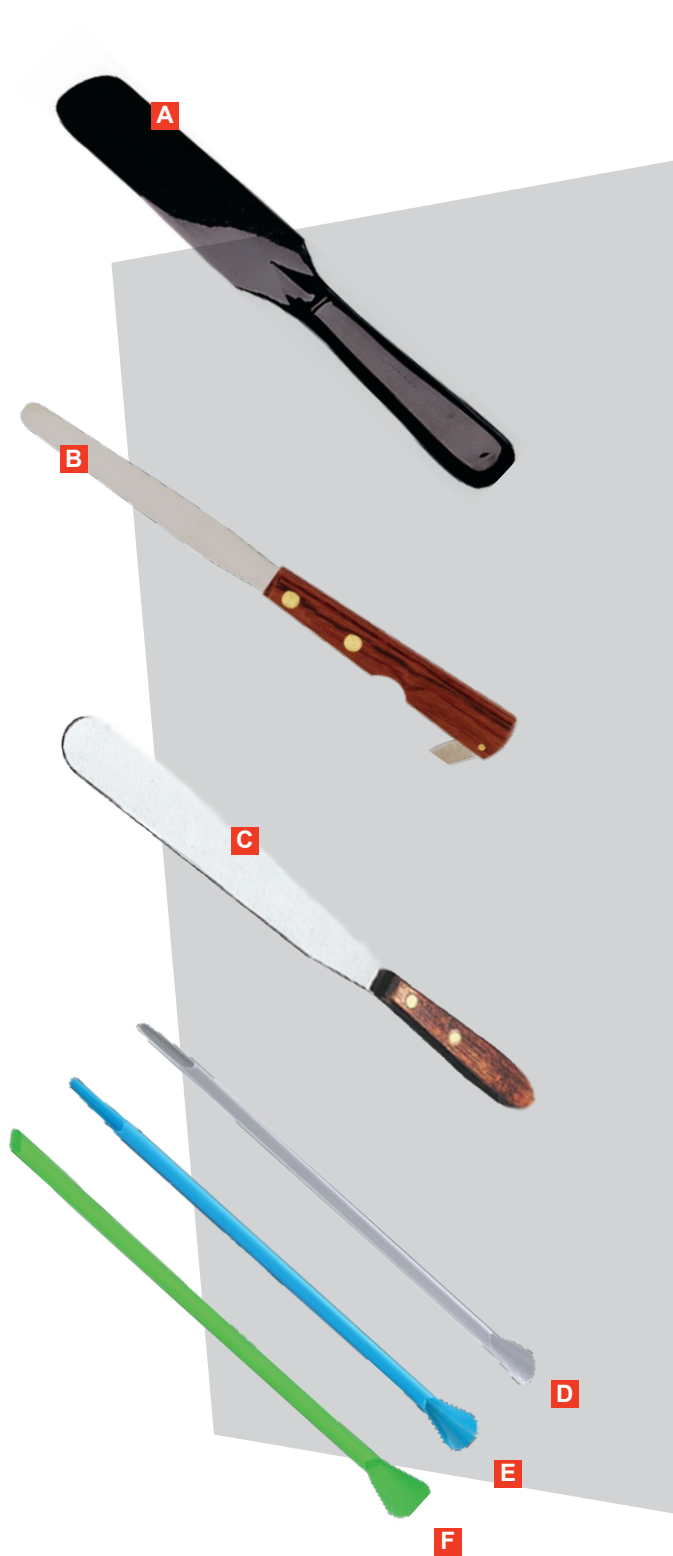



Flint Glass

Flint Glass Mortar & Pestles

- Convenient - Use for preparing medications for patients or compounding recipes.
- Easy to Clean - Can be sterilized, cleaned with alcohol or washed with soap and water.
- **Note:** Not recommended for use with drastic temperature changes.



Wedgewood

Wedgewood Mortar & Pestles

- Convenient - Use for preparing medications for patients or compounding recipes.
- Easy to Clean - Can be cleaned with alcohol or washed with soap and water. Pestles cannot be sterilized because of the wooden handle.
- **Note:** Wedgewood should not be used with flavors or scents because the porous material will retain these elements after they are cleaned.

Mortar & Pestles

Item #	Description	Size
3070	Flint Glass Mortar	2 oz. (60 mL)
3080	Flint Glass Pestle	2 oz. (60 mL)
3071	Flint Glass Mortar & Pestle Set	2 oz. (60 mL)
3072	Flint Glass Mortar	4 oz. (120 mL)
3082	Flint Glass Pestle	4 oz. (120 mL)
3073	Flint Glass Mortar & Pestle Set	4 oz. (120 mL)
3074	Flint Glass Mortar	8 oz. (240 mL)
3084	Flint Glass Pestle	8 oz. (240 mL)
3075	Flint Glass Mortar & Pestle Set	8 oz. (240 mL)
3076	Flint Glass Mortar	16 oz. (480 mL)
3086	Flint Glass Pestle	16 oz. (480 mL)
3382	Flint Glass Mortar & Pestle Set	16 oz. (480 mL)
3053	Wedgewood Mortar & Pestle set	4 oz. (120 mL)
3055	Wedgewood Mortar & Pestle set	8 oz. (240 mL)
3395	Ceramic Mortar & Pestle set	2 oz. (60 mL)
3398	Ceramic Mortar & Pestle set	4 oz. (120 mL)
3401	Ceramic Mortar & Pestle set	8 oz. (240 mL)
3404	Ceramic Mortar & Pestle set	16 oz. (480 mL)
3407	Ceramic Mortar & Pestle set	32 oz. (960 mL)

Ceramic Mortar & Pestles

- Use for preparing medications for patients or mixing and pulverizing ingredients for compounding
- Ceramic models are ideal for compounding tablets and solids
- Can be sterilized, cleaned with alcohol, or washed with soap and water



Ceramic

Ointment Pad

- 12" square
- 100 sheets per pad

Item #	Description	Qty
3088	A 12 x 12" Square	100 Sheets

Glass Ointment Slab

- Glass ointment slab suitable for mixing various preparations
- 12" square
- 1/4" thick

Item #	Description
3098	B 12" Square Slab, 1/4" Thick

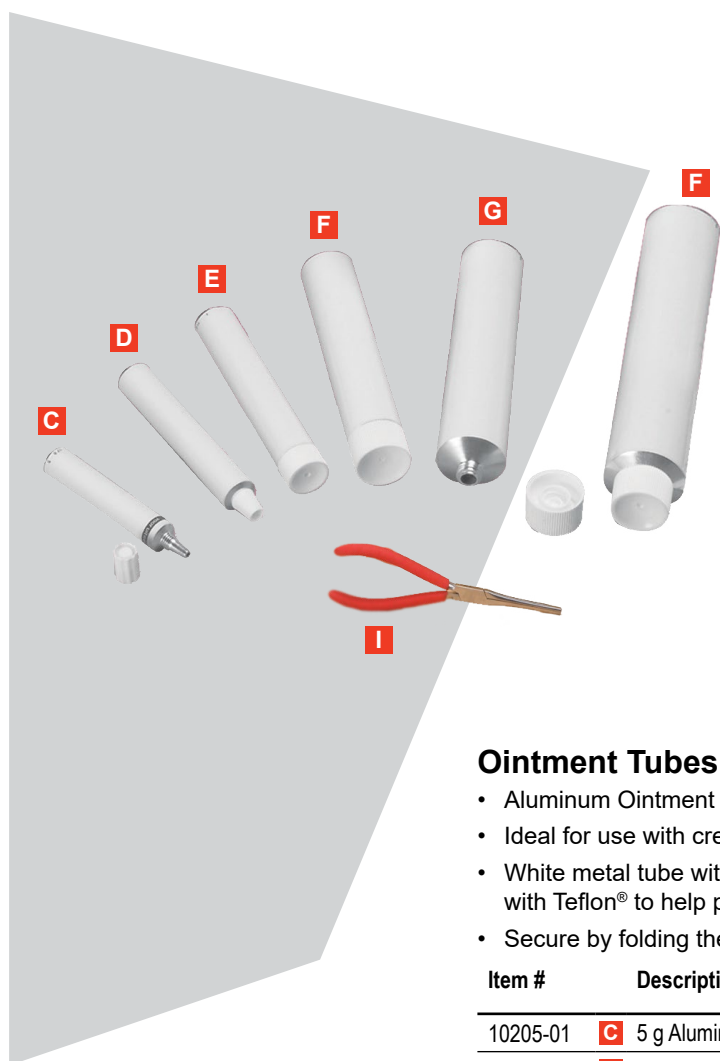
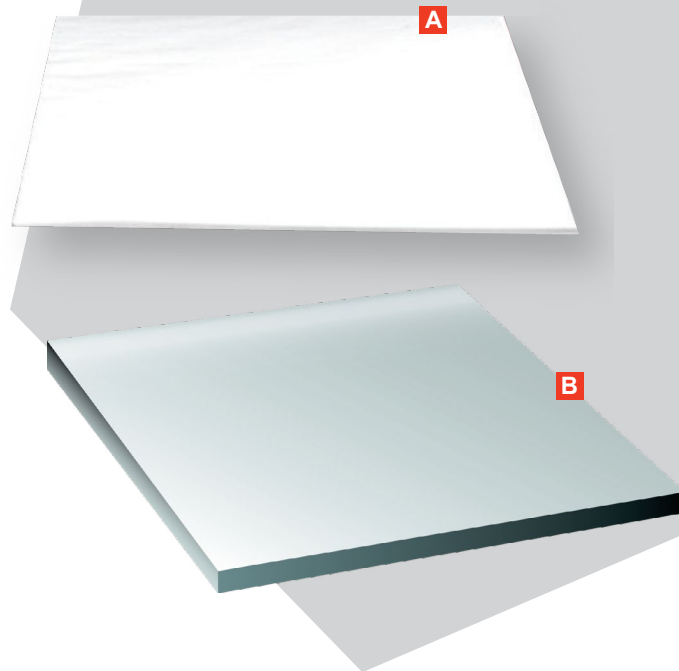

Ointment Tubes

- Aluminum Ointment Tubes (A-F):
- Ideal for use with creams, ointments and topical medications
- White metal tube with white plastic screw cap and plastic ophthalmic tip - tubes lined with Teflon® to help prevent sticking or reactions with the aluminum; autoclavable
- Secure by folding the ends with tongs or pliers

Item #	Description	Qty
10205-01	C 5 g Aluminum Ointment Tube, with Tamper Evident Ring	135
10206-01	D 10 g Aluminum Ointment Tube	100
10201-01	E 15 g Aluminum Ointment Tube	117
10202	F 30 g Aluminum Ointment Tube	12
10203A	G 50 g Aluminum Ointment Tube	12
10204-01	H 100 g Aluminum Ointment Tube	54
4040	I Ointment Tube Pliers	1

Dispensing Containers and Accessories

- Built-In Safety - Bottom closure snaps shut for a tamper-resistant seal
- Maintain Freshness - Screw top lids keep ointments fresh until the last application
- Easy to Use - Simply twist the bottom of the container and the compound is expelled from the top of the container

Item #	Description	Qty
10332	A 30 g Dispensing Container	20
10333	50 g Dispensing Container	20
10334	100 g Dispensing Container	15
10335	B 200 g Dispensing Container	10
10330	C Large Mixing Disc	30



Ointment Jars

- Smart Packaging - Containers come shrink wrapped on paperboard trays to keep them clean and provide convenient storage
- Multi-Purpose - Ideal for packaging and dispensing ointments, gels and creams

Item #	Size	Qty
10083	25 mL	120
10084	40 mL	80
10085	55 mL	80
10086	A 75 mL	35
10087	120 mL	35
10088	170 mL	35
10089	B 250 mL	24
10520	300 mL	10
10521	C 690 mL	10

Dispensette III

- Easy, fast, and mechanically accurate liquid bottle-top dispenser
- Accurate to 0.5% of overall volumes
- Made with non-reactive Teflon®, resistant to wear and damage
- Ideal for dispensing liquid medication, especially methadone
- Long life span when properly maintained (see cleaning note)
- ISO/GLP compliant with certificate of pre-calibration; annual calibration recommended (see note below)

Features:

- 100% Teflon® tubing is non-reactive; ideal for use with methadone
- Recirculation tube prevents waste
- Safety valve prevents clogging and leaking
- Cap keeps out air, and prevents bacteria from growing and affecting methadone or other liquids



Recommendations:

- Digital units are recommended for ease of use and accuracy
- Item # DK107-30 is the size recommended for methadone dispensing
- Recommended to be used with 1 L amber glass bottle
- Use with Class A glass cylinders to verify accuracy of measurements (see page 9 for 1634AA series cylinders)

One-Time Set-up Instructions:



Attach the adapters onto the bottle.

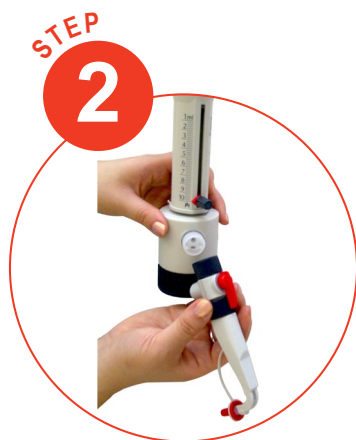

Assemble the discharge tube to the housing unit.



Attach the adjustable filling tube onto the housing unit.



Attach the recirculation tube onto the housing unit. Recirculation tube allows unused liquid to recycle back into the stock bottle without wasting any liquid.

Important Cleaning Instructions: Maintenance for this equipment is very important; especially when dispensing methadone. When each stock bottle is complete, we recommend that you circulate the dispensette with hot water. Methadone crystallizes when exposed to air; without proper cleaning, it can clog the machine over time resulting in incorrect calibration. Should this occur, do not force your Dispensette. If your Dispensette becomes clogged over time please contact PharmaSystems to schedule a cleaning. *Refer to the instructions manual for full cleaning & care Instructions.

Important Note about Calibration: Dispensette includes certificate of calibration valid for 1 year after purchase. Annual calibration is recommended to ensure product accuracy. This service is offered by PharmaSystems for a fee. Please do not attempt to calibrate the Dispensette unless otherwise directed by a PharmaSystems employee as this will void your certificate of calibration.

Dispensettes Include:

Adjustable filling tube & recirculation tube
(accommodates all standard bottle sizes below 1 litre)

Bottle adapters (24, 28, 33, & 38 mm)

Discharge tube

Vale mounting/calibration tool

Certificate of performance

1 year warranty against product defects
(does not include user-handling errors)



Dispensettes

Item #	Type	Volume	Increments	Accuracy	Adapters Included	Filling Tubes Included
DK107-33	Digital	0.5-5 mL	0.02 mL	±25 µL	24, 28, 33, 38 mm	125-240 mm
DK107-30	Digital	1-10 mL	0.05 mL	±50 µL	24, 28, 33, 38 mm	125-240 mm
DK107-50	Digital	10-25 mL	0.1 mL	±125 µL	33, 38 mm	170-330 mm
DK107-36	Digital	5-50 mL	0.02 mL	±250 µL	33, 38 mm	170-330 mm
DK107-13	Analog	0.5-5 mL	0.2 mL	±25 µL	24, 28, 33, 38 mm	125-240 mm
DK107-10	Analog	1-10 mL	0.02 mL	±50 µL	24, 28, 33, 38 mm	125-240 mm
DK107-32	Analog	10-25 mL	0.5 mL	±125 µL	33, 38 mm	170-330 mm
DK107-16	Analog	5-50 mL	1 mL	±250 µL	33, 38 mm	170-330 mm

Accessories

Item #	Description	Compatible with models
DK-201	Extended filling tube accommodates 1 L, 2L and 4 L bottles	DK107-13, DK107-33, DK107-10, DK107-30
DK-205	Extended filling tube accommodates 1 L, 2 L and 4 L bottles	DK107-32, DK107-16, DK107-50, DK107-36
6747	Recirculation Tube for Dispensette III	All models

STEP
5



Attach the housing unit onto the bottle adapter.

STEP
6



Set the valve to "off" mode for recirculation. Select the prescribed dosage amount. Recirculate the medication by pulling the housing unit upwards & downwards to prime the dispenser.

STEP
7



Set the valve to "on" mode, remove the safety cap and dispense the medication by withdrawing it upwards and dispensing it downwards.

View all methadone dispensing supplies & accessories here!

Medication Cups

Item #	Description	Type	Qty
7364	1 oz. / 29 mL Graduated	Plastic	1000
7362	2 oz. / 59 mL Graduated	Plastic	1000
5165	1 oz. / 29 mL Graduated	Plastic	400
5165-01	1 oz. / 29 mL Graduated	Plastic	4800
7360	3.5 oz. / 103 mL	Plastic	100
7361	5 oz. / 147 mL	Plastic	100
7366	5 oz. / 147 mL	Plastic	1200
7369	1 oz / 29 mL	Paper Souffle	1000
7368	1/2 oz / 14 mL	Paper Souffle	1000
7363	3 oz / 88 mL	Wax Paper	2400
7363	3 oz / 88 mL	Wax Paper	2400
5160	Lids for Narrow Cups	Plastic	400
5160-01	Lids for Narrow Cups	Plastic	4000



Amber Plastic Bottles, PET

- Bottle necks measure 24mm – compatible with E-28mm and F-28mm Adapta-Caps (see page 49 for details)

Item #	Description	Includes Caps	Qty
102893	100 mL Amber Plastic Bottles	✓	108
10289	100 mL Amber Plastic Bottles	-	108
102903	200 mL Amber Plastic Bottles	✓	63
10290	200 mL Amber Plastic Bottles	-	63
102913	300 mL Amber Plastic Bottles	✓	48
10291	300 mL Amber Plastic Bottles	-	48
102923	500 mL Amber Plastic Bottles	✓	35
10292	500 mL Amber Plastic Bottles	-	35
102933	1000 mL Amber Plastic Bottles	✓	30
10293	1000 mL Amber Plastic Bottles	-	30
10294	Tamper Resistant Caps (Not child-proof)	-	250

Amber Plastic Dropper Bottles

- Bottle caps have built-in droppers for dispensing or mixing
- Material: Polypropylene

Item #	Size (oz.)	Size (mL)	Qty
10078	½ oz	14 mL	12
10079	1 oz	29 mL	12
10080	2 oz	59 mL	12



Items highlighted in orange are recommended for methadone dispensing

Amber Glass Medicine Bottles

- 28 mm white plastic screw caps included

Item #	Description	Bottle Neck Size	Size	Qty
20050-12	Amber Glass	18 mm	50 mL	264
200100	Amber Glass	18 mm	100 mL	140
200200	Amber Glass	24 mm	236 mL	108
200500-12	Amber Glass	28 mm	500 mL	12
2001000	Amber Glass	33 mm	1 L	12
2001000-01	Amber Glass	33 mm	1 L	1
20020	White Cap For use with 20050 & 200100			100
20026	White Cap For use with 2001000 & 2001000-01			25



Amber Glass Dropper Bottles with Glass Dropper Caps

Item #	Description	Size	Qty.
19450	Amber Glass with Dropper Cap	5 mL	340
19451	Amber Glass with Dropper Cap	10 mL	255
19452	Amber Glass with Dropper Cap	20 mL	216
19453	Amber Glass with Dropper Cap	30 mL	168
19454	Amber Glass with Dropper Cap	50 mL	99
19455	Amber Glass with Dropper Cap	100 mL	68

Screw-on caps have a tamper-evident ring that breaks off to show evidence of access.



Amber Glass Dropper Bottle Accessories

Item #	Description	Qty.
10067	A White Tamper Resistant Caps	100
10068	Black Tamper Resistant Caps	100
19456	B Glass Dropper for 5 mL Bottles	100
19457	Glass Dropper for 10-30 mL Bottles	100
19458	Glass Dropper for 50-100 mL Bottles	100
19459	C Glass Dropper for item # 19453	100



Sterile Amber Glass Eye Dropper & Bottle

- Ideal for preparing individual or small batches of extemporaneous ophthalmic solutions
- Dropper will remain sterile until the cover is removed from tip cap - cover is reusable, protects from contamination, USP 797 compliant
- Tip cap dispenses 50 µL per drop

Item #	Description	Qty
7789	A 10 mL Sterile Dropper & Bottle	10



Calibrated Dropper and Vial

- Dropper: Calibrated from 0.2 - 1 mL for accurate dispensing
- Suitable for pediatric and infant dosing
- Packaged individually
- Vial: Suitable for use with calibrated dropper
- Translucent, made of HDPE

Item #	Description	Qty
7785-01	B 1 mL Calibrated Dropper	10
5703-04	C 30 mL Vial for Calibrated Dropper	10

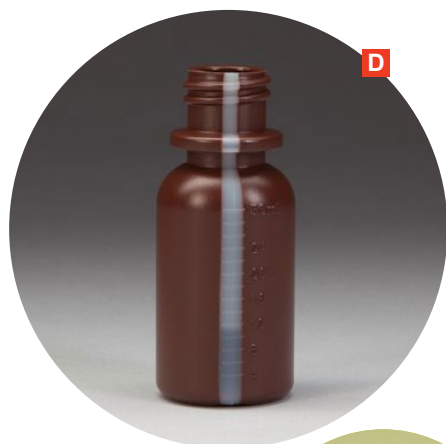

Calibrated Window Vials

- 1 oz (30 mL) vial with unique clear window strip
- Allows users to quickly see the amount of medication in the container
- 25 per package

Item #	Description
17868	1 oz. Amber vial with white calibrated dropper cap
17869	1 oz. White vial with white calibrated dropper cap
17868-01	D 1 oz. Amber vial
17869-01	1 oz. White vial
17870-01	E White Calibrated Dropper cap
17943-01	Black Calibrated Dropper cap
17942-01	White Screw Caps for Calibrated Window Strip Vials



Vial Decappers

- Removes aluminum vial caps
- Made of forged steel for strength and durability, corrosion resistant nickel, and has a chrome plated finish, latex free
- Sizes below correspond to the vial neck diameter, or to the cap size to be removed

Item #	Size
7713	13 mm
7714	20 mm
7720	30 mm



Dual Action Vial Decappers

- Removes aluminum vial caps
- Economical and durable way to remove seals and stoppers that contain latex before preparing syringes for latex sensitive patients
- Sizes below correspond to the vial neck diameter, or to the cap size to be removed

Package includes:

- 1 x Twin Action Decapper Pliers (6 × 4 × 1 in)
- 2 x Cushioned Grips

Item #	Size	Colour
7771	8 mm, 13 mm	Red
7772	11 mm, 20 mm	Blue
7773	13 mm, 20 mm	Orange
7774	8 mm, 30 mm	Green
7775	8 mm, 11 mm	Purple



Amber Sterile Glass Vials

- Sterile Processed - Type 1, USP, borosilicate glass vials are dry-heat sterilized and pyrogen free
- Compatibility - Empty Sterile Vial stoppers are latex free
- **Note:** Caps are not included

Item #	Capacity	Cap Size	Qty
19806	2 ml	13 mm	25
19813	5 mL	20 mm	25
18702	10 mL	20 mm	25
18703	30 mL	20 mm	25
18704	50 mL	20 mm	25
19817	100 mL	20 mm	25

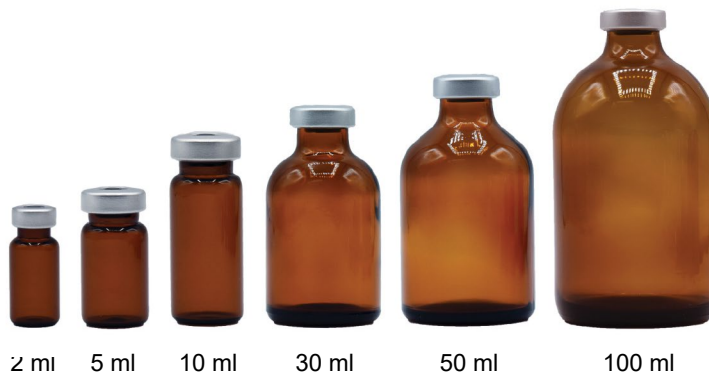

Clear Sterile Glass Vials

- Sterile empty glass vials in compact, durable trays
- De-pyrogenated dry heat sterilization process (no drop of liquid inside) without cap for use in clinical trials
- For vial seals, see pages 55-56

Item #	Capacity	Qty
7760-10	2 mL	100
7761-03	5 mL	25
7761-10	5 mL	100
7762-03	10 mL	25
7762-10	10 mL	100
7766-03	20 mL	16
7763-03	30 mL	25
7765-03	50 mL	25
7764-06	100 mL	25
7763-10	30 mL	100
7764-06	100 mL	25
7765-03	50 mL	25



Check out our vial seals on pages 55 & 56

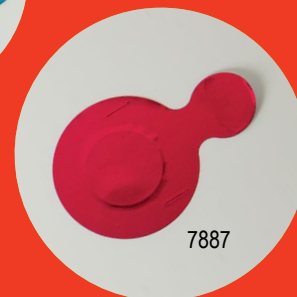



Medicine Vials

- Translucent polyethylene amber vials provide visibility
- Compatible with child-resistant or snap caps (see options below)
- When closed with the Child Resistant Caps, vials pass both child resistant and senior friendly protocol tests
- Use with either caps to meet USP31/NF26 requirements
- Vials and caps pass USP671 Moisture Permeation tests

Item #	Description	Vial Size/Compatible with Vial	Qty
5725	Medicine Vial without Caps	33 mL (9 dram)	475
5726	Medicine Vial without Caps	48 mL (13 dram)	325
5727	Medicine Vial without Caps	60 mL (16 dram)	270
5728	Medicine Vial without Caps	73 mL (20 dram)	200
5729	Medicine Vial without Caps	110 mL (30 dram)	140
5730	Medicine Vial without Caps	148 mL (40 dram)	110
5731	A Medicine Vial without Caps	220 mL (60 dram)	70
5732	Child Resistant Caps	33 mL (9 dram)	250
5733	Child Resistant Caps	48, 60 mL (13, 16 dram)	200
5734	B Child Resistant Caps	73 mL (20 dram)	150
5735	Child Resistant Caps	110, 148, 200 mL (30, 40, 60 dram)	100
5736	Snap Caps	33 mL (9 dram)	300
5737	Snap Caps	48, 60 mL (13, 16 dram)	200
5738	Snap Caps	73 mL (20 dram)	150
5739	C Snap Caps	110, 148, 200 mL (30, 40, 60 dram)	100
572532	D Medicine Vial with Child Resistant Cap Attached	33 mL (9 dram)	100
572633	Medicine Vial with Child Resistant Cap Attached	48 mL (13 dram)	100
572733	Medicine Vial with Child Resistant Cap Attached	60 mL (16 dram)	100
572834	Medicine Vial with Child Resistant Cap Attached	73 mL (20 dram)	100
572935	Medicine Vial with Child Resistant Cap Attached	110 mL (30 dram)	100
573035	Medicine Vial with Child Resistant Cap Attached	148 mL (40 dram)	100
573135	Medicine Vial with Child Resistant Cap Attached	220 mL (60 dram)	100
572536	E Medicine Vial with Snap Cap Attached	33 mL (9 dram)	100
572637	Medicine Vial with Snap Cap Attached	48 mL (13 dram)	100
572737	Medicine Vial with Snap Cap Attached	60 mL (16 dram)	100
572838	Medicine Vial with Snap Cap Attached	73 mL (20 dram)	100
572939	Medicine Vial with Snap Cap Attached	110 mL (30 dram)	100
573039	Medicine Vial with Snap Cap Attached	148 mL (40 dram)	100
573139	Medicine Vial with Snap Cap Attached	220 mL (60 dram)	100

Multi-Purpose Vial Holder

- Clear, acrylic, multi-purpose vial holder
- Ideal for transporting laboratory samples and pharmacy prescriptions
- Rack has 14 holes measuring 1" and 1½"
- Holder measures: 11¾" W x 1⅞" H x 3" D

Item #

18536 **A**



Easy Read Vial Stands & Grippers

- Silicone grippers hold vials, tubes, and syringes at an angle so labels are easy to read
- Angled stands fit neatly inside crash cart boxes
- Stands can be mounted or placed on countertops for easy access
- Small (1/3 length) measures: 6⅜" W x 1⅝" H x 2¾" D; stand fits crash cart box # 3150
- Medium (1/2 length) measures: 9⅞" W x 1⅝" H x 2⅜" D; stand fits crash cart box # 3131
- Large (full length) measures: 21⅞" W x 1⅝" H x 2¾" D; stand fits crash cart box # 1814

Item #	Description	Qty
18832	B Small Vial Stand And Gripper Set	1
18833	C Medium Vial Stand And Gripper Set	1
18834	D Large Vial Stand And Gripper Set	1
18835	E Small Easy Read Vial Gripper	5
18836	Medium Easy Read Vial Gripper	5
18837	Small Easy Read Vial Stand	1
18838	Medium Easy Read Vial Stand	1
18839	Large Easy Read Vial Stand	1

Silicone Grippers hold vials, tubes & syringes at an angle so labels are easy to read. Small Grippers are ideal for 13 mm caps; Medium Grippers are ideal for 20 mm caps.

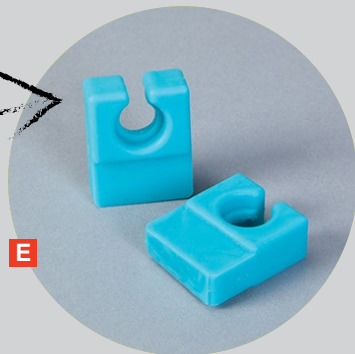
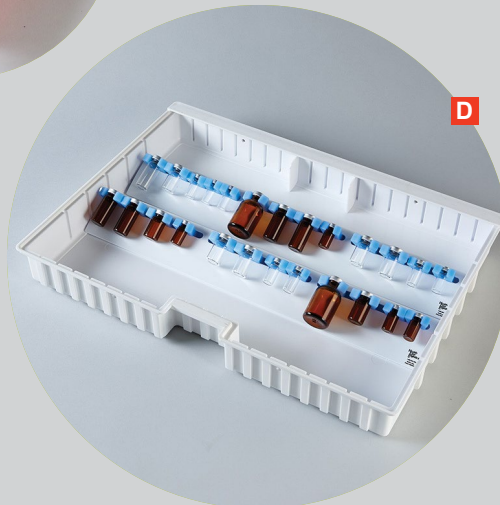

Spray Bottles

- Bottle and atomizer tip with dip tube and screw-on lid.
- Material - Polyethylene bottles

Item #	Size	Qty
7701	A 15 mL	12
7702	15 mL	144



Metered Pump Nasal Spray Bottle

- Controlled Dispensing - Delivers 0.1cc per pump for a consistent dose.
- Material - Polyethylene bottles

Item #	Capacity	Qty
10271	B 1 oz	12
10272	2 oz.	12



Sterile Dropper Bottles

- Sterility Assurance - Ideal for the preparation of sterile ophthalmic solutions. Bottle exterior is sterile until the package is opened; the inside is sterile until the cap is removed.
- All-in-One System - Includes snap-in dropper tips and screw on caps.
- Controlled Dispensing - Releases approximately 42uL per drop and the dispensing tolerance is +/- 5uL

Item #	Size	Amount dispensed per drop	Qty
7780	C 3 mL	0.023 mL	12
7780-02	3 mL	0.023 mL	2
7782	7 mL	0.035 mL	12
7782-01	7 mL	0.035 mL	1
7784	15 mL	0.035 mL	12
7784-01	15 mL	0.035 mL	1
7786	30 mL	0.035 mL	12
7786-01	30 mL	0.035 mL	1



Wash Bottle

- Wide mouth for fast, easy filling
- Bottle and tube molded in one piece to prevent leaking
- Contents can be dispensed without tipping or shaking
- Made of LDPE

Item #	Description	Qty
70125	D 125 mL	1
70250	250 mL	1
70500	E 500 mL	1



Plastic Cylinder Bottles & Accessories

- Use for mixing, sampling, storing and dispensing
- Made of durable HDPE
- Caps sold separately

Item #		Description	Qty.
10407	A	100 mL Cylinder Plastic Bottles	50
10408		250 mL Cylinder Plastic Bottles	54
10409	B	500 mL Cylinder Plastic Bottles	28
10410		1000 mL Cylinder Plastic Bottles	60
10411		Screw Cap for Plastic Cylinder Bottles	100
10412	C	Child Resistant Screw Cap for Plastic Cylinder Bottles	100
10413	D	Flip Top Cap for Plastic Cylinder Bottles	100
10414	E	Spray Pump for Plastic Cylinder Bottles	50

Packer Bottles with Pressure Seal Liners

- All-in-one packaging solution saves users from purchasing and storing bulk items separately.
- Caps feature a built-in liner that seals to the bottle without the need for special equipment
- Amber HDPE bottle protects light-sensitive contents
- 100 per package

Item #		Description	Colour	Size
20826A	F	Packer Bottles & Threaded Caps with Pressure Seal Liners	Amber	15ml
20826N	G	Packer Bottles & Threaded Caps with Pressure Seal Liners	Natural	15ml
20827A		Packer Bottles & Threaded Caps with Pressure Seal Liners	Amber	30ml
20827N		Packer Bottles & Threaded Caps with Pressure Seal Liners	Natural	30ml
20829A		Packer Bottles & Child Resistant Caps w/ Pressure Seal Liners	Amber	15ml
20829N		Packer Bottles & Child Resistant Caps w/ Pressure Seal Liners	Natural	15ml
20830A		Packer Bottles & Child Resistant Caps w/ Pressure Seal Liners	Amber	30ml
20830N		Packer Bottles & Child Resistant Caps w/ Pressure Seal Liners	Natural	30ml

Fretwell's Triangle

- Count regular shaped tablets with absolute accuracy and speed
- Tablets glide easily on the stainless steel triangle
- Easy to clean

Item #

FT1 **A**

Tablet Counters

- Plastic pill counting tray with clear lip handle and two corner spouts
- Effective way to keep organized with pill counting
- Includes plastic spatula to aid counting and transferring pills
- Recommended for right-handed users
- Measures: 3½ x 21 x 16 cm

Item #

D-50 **B**

Ergonomic Tablet Counters

- Includes spatula with ergonomic grip for easy handling and docking slot
- Designed to provide stability while counting tablets
- Deep blue colour allows pills and powder traces to contrast with tray
- Measures: 7¾"W x 6⅞"H x 1⅜"D

Item #	Description
7147	Right-Handed
7148	C Left-Handed

Ambidextrous Tablet Counter

- Polyethylene pill counting tray for left or right handed users
- Spatula included
- Chute has a hinged cover for easy filling
- Measures: 7¾" x 6¼" x 1½"

Item #	Description
12261	D Left or Right Handed

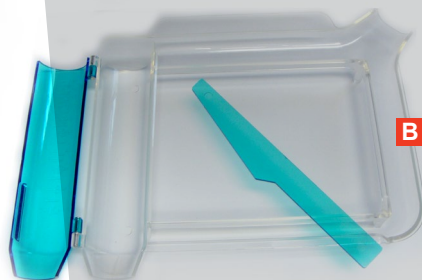
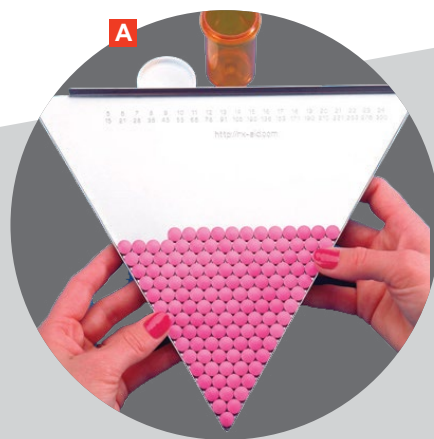

Test Tube Racks

- Safe Transport - Keeps tubes size 5-10 mL upright to reduce the risk for spills and the need for repeat testing
- Easy to Clean - Autoclavable; reduces the risk for cross-contamination.

Item #	Description	Count
19974	A Test Tube Rack, Full size, 13 mm	72
19975	Test Tube Rack, Full size, 16 mm	72
19976	B Test Tube Rack, Half size, 13 mm	36
19977	Test Tube Rack, Half size, 16 mm	36

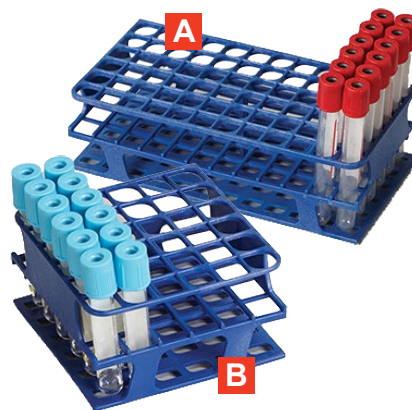

Medication Envelope

- Quick and simple way to package and dispense medication prepared in small quantities
- Write-on area for patient information and instructions
- Made of white paper
- Measures: 2¼ x 3½"

Item #	Qty
8020	250

Stainless Steel Trays

- Heavy duty
- Stainless steel trays are easy to clean, disinfect and sterilize
- Versatile - Heavy-gauge Stainless Steel tray can be used as a processing, medical supply or pass-through tray to the cleanroom
- Seamless Interior - Non-corrosive tray has open corners and easy-grip handles and nests when empty.

Item #		Dimensions (W x H x D)	Gauge
18779	A	11.68 x 2.06 x 6.375"	18
18665	B	14.93 x 2.25 x 9.18"	18
18783	C	12 x 0.5 x 9"	18
20252	D	20.75 x 4 x 12.75"	24
19308	E	10 x 0.75 x 6.5"	24
20253	F	13.625 x 0.62 x 9.75"	24
20257	G	12.25 x 2.125 x 7.625"	24



AkroBins

- Durable and long-lasting AkroBins are the industry standard for plastic storage bins
- Heavy-duty, sturdy, one-piece construction is water, rust and corrosion-proof
- Many great organization options are available - stack bins, hang on racks, wall panels, louvered panels, or use on mobile carts
- Reinforced ribs prevent bins from spreading or losing shape
- Large front label slot allows for labelling and relabelling system.
- Take advantage of colour options available to create a colour-coded organization system to control inventory
- Ideal for Kanban visual organization systems and 5S Lean initiatives
- Customize organization system to meet your unique needs – select from standard size bins, super-size bins, bin dividers, clear or amber lids, and many hanging organization strategies

Item #	Outside Dimensions			Capacity (lbs.)	Qty
	Length	Width	Height		
1400	5-3/8"	4-1/8"	3"	10	24
1401	10-7/8"	5-1/8"	4"	30	12
1403	14-3/4"	5-1/2"	5"	60	12
1405	7-3/8"	4-1/8"	3"	10	24
1410	10-7/8"	5-1/2"	5"	30	12
1412	10-7/8"	11"	5"	60	6
1413	10-3/4"	8-1/4"	7"	60	6
1415	14-3/4"	8-1/4"	7"	60	12
1417	10-7/8"	16-1/2"	5"	60	6
1420	14-3/4"	16-1/2"	7"	75	6
1434	18"	8-1/4"	9"	75	6
1438	18"	16-1/2"	11"	75	3



Amber lids are ideal for storing light-sensitive medication or IV's

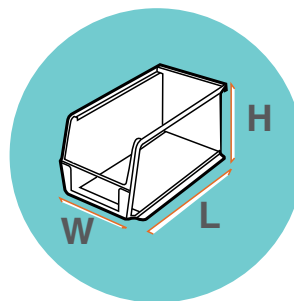

Refer to this outside measurement diagram for all AkroBins® and Insight bins by Akro-Mils®.



Super Tough Bins with Clear or Amber Lids

- Select from clear or amber lids, attached or sold separately
- Shield Supplies: Transparent lids keep contents dust-free and protected.
- Easy Content ID: Label slots hold fanfold, roll or laser labels
- Compatible - Waterproof, oil and chemical resistant. Lids keep contents protected
- Bins with lids can still be stacked (however lids cannot be opened when stacked)
- Specify colour when ordering

Item #	Description	Lid Colour	Fits Akro Bin
1672	Bin with Lid	Clear	#1400
1673	Bin with Lid	Clear	#1405
1676	Bin with Lid	Clear	#1410
1558-01	Bin with Lid	Amber	#1410
1555	Bin with Lid	Clear	#1420
1556	Bin with Lid	Amber	#1420

Dividers for AkroBins

- Divides bin front to back
- Material: Made of industrial grade polymers
- 6 dividers per package

Item #	Fits Bin Number(s)	Colour
1931	1400	Black
1933	1405	Black
1935	1410, 1412	Black
1936	1413	Black
1937	1415, 1420	Black
1968	1401	Clear
1973-01	1403	Clear



Super-sized AkroBins

- Large size conducive for large, heavy items
- Sturdy - Reinforced sides keep bins from spreading.
- Weight Capacity - 60 - 75 lbs.
- Available in ● red, ● yellow or ● blue - please specify colour when ordering
- **Note:** Bins can't be hung from panels or rails.



Item #		Outside Dimensions			Capacity (lbs.)	Qty
		Length	Width	Height		
1404	A	20"	12-3/8"	6"	60	4
1406		20"	12-3/8"	8"	60	3
1407	B	20"	12-3/8"	12"	75	2
1408	C	20"	18-3/8"	12"	75	1
1409		29 1/4"	18-3/8"	12"	75	1



Shelf Bins

- Fits standard 12", 18" and 24" shelving (see length below)
- Customize to fit organization needs using bin dividers or bin cups (sold separately)
- Durable polypropylene construction allows Shelf Bins to be fully loaded without bulging or cracking
- Waterproof one-piece construction is unaffected by grease or oil
- Molded label holder for identifying contents
- **Note:** Bins are not made for stacking

Item #		Outside Dimensions (L x W x H)	Case Qty	Small/ Large bin cups fit per bin	Divider Item #
1435	A	11-5/8 x 2-3/4 x 4"	24	3/-	-
1440		11-5/8 x 4-1/8 x 4"	24	5/2	1941 (7)
1445	B	11-5/8 x 6-5/8 x 4"	12	9/2	1943 (7)
1447		11-5/8 x 8-3/8 x 4"	12	11/4	1947 (7)
1448		11-5/8 x 11-1/8 x 4"	12	15/6	1948 (7)
1450		17-7/8 x 4-1/8 x 4"	12	8/3	1941 (7)
1455		17-7/8 x 6-5/8 x 4"	12	15/6	1943 (7)
1457		16-1/2 x 7-1/8 x 4"	12	15/6	1947 (7)
1456		16-1/2 x 11-1/8 x 4"	12	25/12	1948 (7)
1451	C	22-1/8 x 4-1/8 x 4"	12	11/4	1941 (7)
1458		23-5/8 x 6-5/8 x 4"	6	21/8	1943 (7)
1459		23-5/8 x 8-3/8 x 4"	6	25/8	1947 (7)
1454		23-5/8 x 11-1/8 x 4"	6	35/16	1948 (7)

Shelf Bin Dividers

- Polypropylene dividers create compartments within Shelf Bins
- Each bin can hold up to 7 dividers to create 8 compartments (except for item #1435, not compatible with dividers)
- Six dividers per pack

Item #	Colour	Width	Fits Shelf Bin #
1941	D Black	4"	1440, 1450 and 1451
1942-01	Clear	4"	1440, 1450 and 1451
1943	Black	6"	1445, 1455 and 1458
1947	Black	8"	1447, 1457 and 1459
1948	Black	11"	1448, 1456 and 1454

Bin Cups (for Shelf Bins)

- Use to keep small parts separated and organized within Shelf Bins
- White, made of industrial grade polymers

Item #		Outside Dimensions (W x H x D)	Qty
1949	E	3-1/4 x 3 x 2"	48
1950		5 x 3 x 2-3/4"	24



Hanging Rail and Louvered Panels

- Space Saving - Bin Rails allow users to reclaim valuable floor space by hanging nearly an entire wall full of filled bins in one convenient location.
- Quick Access - Use to store orders awaiting delivery, dispensing supplies, at nursing stations, in supply rooms, for convenient storage of IV and treatment supplies, etc.
- Beige powder-coated finish
- Ideal for use with AkroBins®, Insight Bins, and Hanging Wire Bins
- **Note:** Bins are sold separately

Item #	Description	Dimensions (W x H)
1433	A Rail	48 x 3"
1423	Louvered Bin Panel (XS)	18 x 19"
1425	Louvered Bin Panel (S)	35-3/4 x 19"
18562	B Louvered Bin Panel (M)	18 x 61"
17484	Louvered Bin Panel (L)	36 x 61"
18563	C Louvered Bin Panel (XL)	48 x 61"



Half Size Bins

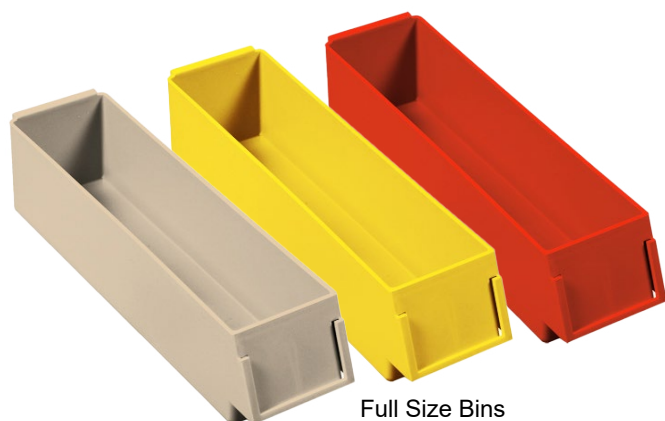

Full Size Bins

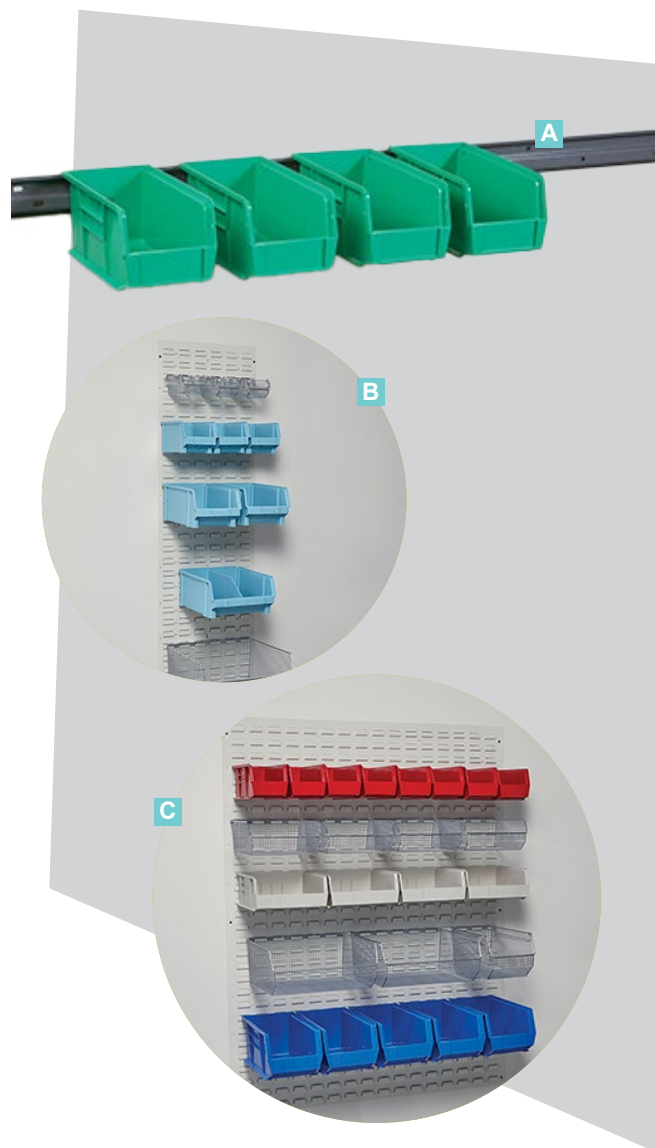

Unit Dose Bins

- Ideal for efficient dispensing and inventory control
- Fits 12" deep shelves
- Half-size can stack 2 deep on 12" shelves, convenient for tight spaces
- Back panel hanging lip can hang from panels and carts
- Made of durable polyethylene copolymer
- Available in ○ clear, ● grey, ● ivory, ● light blue, ● red or ● yellow - please specify colour when ordering

Item #	Size	Outside Dimensions L x W x H	Case Qty
5305-01	Full Size	11-7/8 x 3 x 2-3/4"	1
5310	Full Size	11-7/8 x 6 x 2-3/4"	12
5301-01	Half Size	6-9/16 x 2 x 2-3/4"	1
5302-01	Half Size	6-9/16 x 3 x 2-3/4"	1

Deluxe Shelf Caddies

- Less Contamination - Made of non-shedding plastic to reduce the risk of contamination.
- Disposable - Offers a cost effective alternative to heavy-duty plastic storage containers.
- Lightweight & Convenient - Durable design is lightweight yet sturdy to prevent stacked bins from collapsing. Ideal option for supply storage on pharmacy carousels.
- Compact Storage - Ships flat

Item #		Outside Dimensions (L x W x H)	Qty
9070	A	12 x 2 x 4"	25
9071		12 x 4 x 4"	25
9072	B	12 x 6 x 4"	25
9073		12 x 8 x 4"	25
9074		18 x 4 x 4"	25
9075		18 x 6 x 4"	25
9076	C	18 x 8 x 4"	25

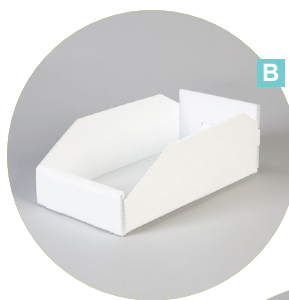

Cardboard Shelf Caddies

- Ideal for disposable use (ie: infection control areas, hazardous product storage, etc.)
- Budget Friendly - Our most economical bins ship flat for reduced shipping costs.
- Convenient - Write-on surface for quick labeling.
- Disposable - Cardboard bins can be recycled. When a bin is dirty, simply replace it. No need to clean!
- Compact Storage - Ships flat

Item #		Outside Dimensions (L x W x H)	Qty
7458		12 x 2 x 4-1/2"	50
7460	D	12 x 4 x 4-1/2"	50
7465		12 x 6 x 4-1/2"	50
7475	E	12 x 12 x 4-1/2"	50



Waterloo® Locking Cassettes

- Enclosed to protect bins from dust and contaminants
- Trays between tiers protect against spillage and medication migration
- Lift-handle on top of the cassette for easy handling, top handle lays flat for stacking
- Multi-tier cassettes and three drawer sizes allows for customization depending on organization needs - bins, dividers and labels sold separately, see below
- Made of a combination of steel and aluminum
- Independently lockable

Item #	# of Tiers	Outside Dimensions (W x H x D)	Weight
1343	A 2	20-7/16 x 7-13/16 x 10"	16 lbs.
1344	B 3	20-7/16 x 10-3/4 x 10"	16 lbs.
1346	C 4	20-7/16 x 13-5/8 x 10"	19 lbs.

Bins for Waterloo® Locking Cassettes

- Sort Supplies - Bins are ideal for efficient dispensing and inventory control
- Easy Content ID - Bin Fronts have label slots for quick supply identification. Ideal for efficient dispensing and inventory control of strips, orals, ampules, vials, and other small items
- One plastic label protector included with each bin
- Colour: Light blue
- Ideal for storage in Waterloo® locking cassettes (above)

Item #	Outside Dimensions (W x H x D)	Compatibility with			Qty
		2-Tier #1343	3-Tier #1344	4-Tier #1346	
1321-01	9-3/4 x 3 x 2-1/2"	12	18	24	1
1322-01	D 9-3/4 x 4-1/2 x 2-1/2"	8	12	16	1

Dividers for Waterloo® Locking Cassettes

- Organize bins with dividers placed side to side or front to back
- White in colour
- 6 per package

Item #	Description	Direction	Bin Compatibility
1916	E Long Divider	Front to back	1321, 1322, 1323
1912	F Short Divider	Side to side	1321

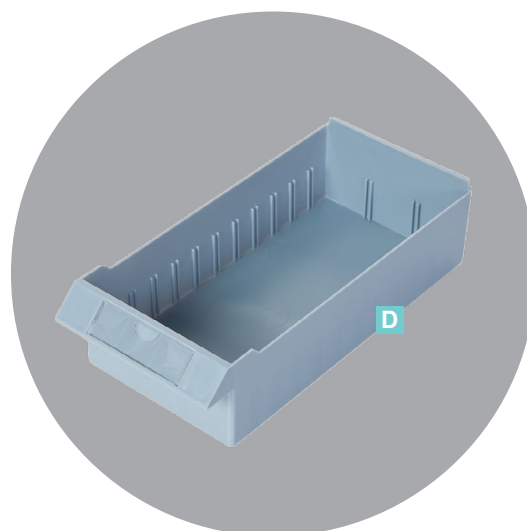

Cassettes

- Keep multiple medications and supplies organized at nursing stations, offices, storage rooms and clinics for quick access.
- Made of lightweight powder-coated steel. The bins are made of hi-impact polystyrene.
- Color Options - Available in Blue or Gray. Specify color when ordering.
- Dividers for drawers are sold separately, see below (fits side to side, 25 per package)

Item #		Number of Bins Included	Bin Dimensions (W x H x D)
1340	A	28 (Item # 1300)	2-3/16 x 2-1/8 x 10-9/16"
1345	B	20 (Item # 1305)	3-1/8 x 2-1/8 x 10-9/16"
1352	C	9 (Item # 1320)	5-3/16 x 3 x 10-9/16"

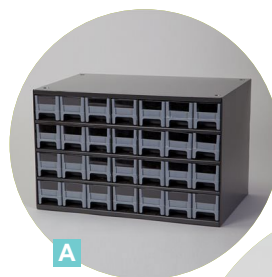

A

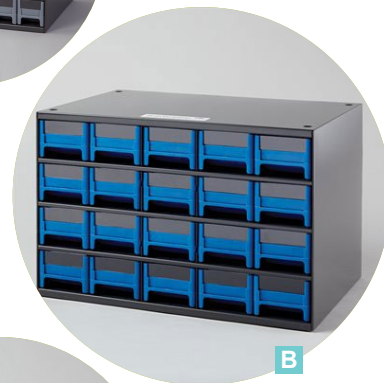

B



C

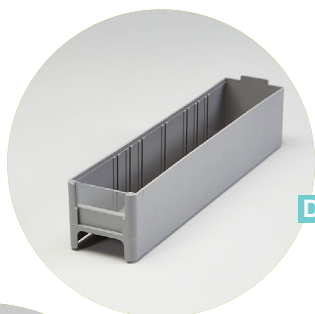

D



E

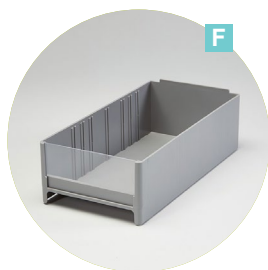

F



G

Additional Bins for Cassettes

- Quick Access - Bins are ideal for patient medications and small supply storage. These bins are replacements for Cassettes (above)
- Protect Labels - Bin window included with each bin. Replacement windows are also available.
- Identify Contents - Bin fronts have label slots for quick supply identification. Cardstock, fan-folded labels sold separately.
- Sort Contents - Dividers are available to divide bins from side-to-side.

Item #		Outside Dimensions (W x H x D)	Bin Qty	Use with Divider # (25 per package)
1300	D	2-3/16 x 2-1/8 x 10-9/16"	1	1907
1305-01		3-1/8 x 2-1/8 x 10-9/16"	1	1909
1308-01		4 x 2-1/8 x 10-9/16"	1	1911
1315-01	E	3-3/16 x 3 x 10-9/16"	1	1915
1320-01	F	5-3/16 x 3 x 10-9/16"	1	1917
1320	F	5-3/16 x 3 x 10-9/16"	15	1917

Plastic Floor Stock Cassettes

- Black rugged, high-impact polystyrene frame resists damage in shipping and storage
- Drawers are molded of semi-clear polypropylene
- Front-to-back dividers are included and are molded into cabinet back; simply cut them out of the frame to remove
- Recessed tray tops allow cassettes to stack

Item #		Outside Dimensions (W x H x D)	Drawers per cabinet
1368		20 x 15-1/2 x 6-3/8"	12 Large, 32 Small
1365	G	10-1/2 x 8-1/2 x 6-3/8"	16 Small

Divider Boxes

- Stackable - recessed stacking ledges protect contents
- Injection molded of tough and durable polypropylene plastic for strength and uniform wall thickness
- Resistant to most solvents, chemicals, stress cracks and is autoclavable at 121°C for two minutes
- Specify colour when ordering (blue, grey, red, semi-clear, or light-blue)
- Accessories are available separately: lids (below), security seals, or contact us for dividers, and label holders
- Also available with pre-drilled holes for security seals - contact us for details

Item #	Outside Dimensions (L x W x H)	Colour
1700	A 10-7/8 x 8-1/4 x 5"	●
1705	16-1/2 x 10-7/8 x 6"	● ● ●
1710	16-1/2 x 10-7/8 x 8"	● ●
1715	22-3/8 x 17-3/8 x 8"	● ● ●
1723	B 16-1/2 x 10-7/8 x 3-1/2"	● ● ●
1724	C 10-7/8 x 8-1/4 x 2-1/2"	● ●
1725	10-7/8 x 8-1/4 x 3-1/2"	● ● ●
1891	16-1/2 x 10-7/8 x 4"	● ●
1892	22-3/8 x 17-3/8 x 10"	● ●
1893	22-3/8 x 17-3/8 x 4"	● ● ●
1894	22-3/8 x 17-3/8 x 6"	● ● ●

Divider Box Accessories

- Lids include lift-holes providing an area to secure the box with security seals (sold separately)
- Semi-clear snap-on lids fit over the top edges of the box
- Clear deluxe lids fit on inside rim of boxes

Item #	Lid Type	Fits Box #'s
1732	D Deluxe Lid	1893, 1894, 1715, 1892

Locking Wall Box with Digital Lock

- Clear wall-mount locking storage boxes keep critical medications and loose supplies visible and secure in a consistent location.
- Includes Keyless Entry Digital Lock, which uses a four-digit code and offers immediate access control with three levels of user admittance (no audit trail).
- 1/8" thick acrylic plastic boxes.
- Boxes have pre-drilled mounting holes
- Custom box sizes available. Contact us to learn more!

Item #	Outside Dimensions (W x H x D)
18557	E 11 x 3 x 23/4"



Tote Boxes

- Tough, versatile plastic totes stack and nest to provide efficient supply storage and transportation efficiency
- Totes will stack with or without lids and can be turned 180° to nest when empty for maximum storage capacity
- Ribs on sides help prevent jamming when nested
- Can withstand temperature ranges from -12°C to 121°C (-10°F to 250°F)
- Optional lids available (sold separately, see options below) and can be secured with security seals (see pages 30-31)
- Clear label holders can be attached to the side of the tote for quick supply identification (item #1683)
- Available in ● blue, ● grey and ● red - please specify box and lid colour when ordering

Item #	Outside Dimensions (L x W x H)	Lid Compatibility (Lid Item #)
1603	A 18 x 11 x 6"	1624
1604	18 x 11 x 9"	1624
1607	19-1/2 x 13-1/2 x 8"	1627
1605	19-1/2 x 15-1/2 x 10"	1626
1606	19-1/2 x 15-1/2 x 13"	1626
1614	B 23-1/2 x 15-1/2 x 12"	1629
1612	23-1/2 x 19-1/2 x 13"	1628
1618	C 29-1/2 x 19-1/2 x 15"	1632
1638	D Label Holders - Holds 3 x 5" labels	-



Flip Top Boxes

- Boxes flip open easily for quick access- no fumbling with awkward closures
- Ideal for packaging and dispensing small quantities of medication
- Made of polypropylene plastic
- Secure with pull-tight seals
- 5 per package

Item #	Colour	Capacity	Outside Dimensions (W x H x D)
5100	E Clear	4 Dram/15 mL	1-1/8 x 1-5/8 x 1-1/16"
5102	Clear	9 Dram/33 mL	1-5/8 x 2-1/2 x 1-1/16"
5104	F Clear	19 Dram/70 mL	1-5/8 x 2-1/2 x 1-3/8"
5121	Clear	38 Dram/140 mL	3-3/4 x 1-5/8 x 2-3/4"
5106	Clear	42 Dram/155 mL	2-1/8 x 2-5/8 x 2-1/8"
5108	G Clear Tapered	104 Dram/384 mL	4-1/4 x 1-3/4 x 4-11/16"

Removable lids with double latches ensure that lids remain secure & provides a stable, secure stacking surface!



Totes with the same length and width will nest without lids

Store Totes with Lids

- Combines the ability to stack with the durability and affordability of smart storage and transport totes for supplies
- Features built-in carrying handles for easy lifting and handling
- Reinforced heavy-load bottoms
- Withstand temperature ranges from -40°C to 120°C
- Made of durable polypropylene plastic
- Available in ○ clear or ● grey; specify colour when ordering

Item #	Capacity	Dimensions (L x W x H)
13200	A 1 Litre	7-7/8 x 6-11/16 x 2"
13201	B 2 Litres	7-7/8 x 6-11/16 x 3-15/16"
13202	C 3 Litres	7-7/8 x 6-11/16 x 5-1/2"
13203	8 Litres	13-3/16 x 8-7/8 x 6-1/8"
13204	15 Litres	15-3/4 x 11-13/16 x 7-1/4"
13206	35 Litres	27-9/16 x 15-9/16 x 7-1/8"
13207	50 Litres	19-11/16 x 15-3/8 x 15-3/4"
13208	70 Litres	27-9/16 x 15-9/16 x 15"



Hinged Lid Transfer Boxes

- Attached, hinged lids open and close easily with a tight interlocking fit
- Stack when filled and nest when empty with anti-jamming nesting tabs
- Lids can be sealed with security seals (sold separately)
- Moulded-in handle grips for easy lifting and handling
- Boxes have full length steel hinge pins for durability

Item #	Outside Dimensions (W x H x D)	Colour
5510	20-5/8 x 13-1/4 x 11-1/2"	●
5515	21-7/8 x 15-3/16 x 9-1/4"	● ● ●
5537	26-1/8 x 12-3/4 x 17"	●
5531	11-3/4 x 9-3/4 x 7-3/4"	● ●
5532	D 19-3/4 x 11-3/4 x 7-1/4"	● ● ●
5533	21-3/4 x 12-7/8 x 1-51/16"	●
5534	15-1/8 x 10-7/8 x 9-3/4"	● ● ●
5535	21-7/8 x 15-3/16 x 9-1/4"	●
5536	E 26-1/8 x 12-3/4 x 17"	● ● ●
5545	27-5/8 x 20-5/8 x 15-9/16"	● ● ●
5550-01	21-1/2 x 19 x 13"	●
5551-01	21-3/4 x 15-1/8 x 13"	● ● ●
5552-01	F 21-1/2 x 18-1/2 x 17"	●

Store-Max 8 Inch High Bin

- Oversized: 95% more storage capacity than standard 4"H bins.
- Versatile: Use with 12", 18" and 24"D shelving units.
- Complete Access: Built-in rear notches allow bins to safely tilt out.
- Color Options - Available in Blue and Clear. Specify color when ordering.
- Easy Content ID: Label slot holds Bin Label (7165).
- Sort Contents: Divides bin side-to-side (18945, sold separately) to keep supplies sorted and maximize organization.

Item #	Dimensions (W x H x D)
18937	6 x 8 x 17"



Stainless Steel Trays

- Heavy-gauge stainless steel tray can be used as a processing tray, medical supply organizing tray or a pass-through tray to the cleanroom
- Ideal for the pharmacy and lab use
- Seamless, non-corrosive metal tray has open corners and easy-grip handles and nests when empty
- View all stainless steel trays on page 32

Item #	Size	Dimensions (W x H x D)
18779	Small	11-11/16 x 2-1/16 x 6-3/8"
18665	Large	15 x 2-1/4 x 10-3/16"
18783	Shallow	12 x 1/2 x 9"

Nest and Stack Totes and Lids

- Totes nest inside each other when empty to save floor and counter space and can be stacked on top of each other when closed with a lid
- Optional dual purpose lids can be used as trays (sold separately)
- Withstand an extreme range in temperature 15°C (60°F) to 121°C (250°F)
- Weight capacity of 500 lbs. (226.8kg)
- Thin wall design and construction give maximum strength while remaining lightweight
- Made of fiberglass-reinforced polyester
- Autoclavable up to 250°C (121°C at 15 lbs./sq. in.)
- Specify colour: ● grey, ● green, ● blue, ● red and ● yellow
- *Only available in grey

Item #	Outside Dimensions W x D x H	Lid Item #
5593	9-7/8 x 6-1/4 x 2-1/8"	5751
5594	9-7/8 x 6-1/4 x 4-1/2"	5751
5595*	11-15/16 x 8-7/8 x 4-1/8"	5752
5596*	12-7/16 x 9-7/8 x 2-1/8"	5753



Mesh Basket

- Compact - Plastic baskets in three sizes provide multiple storage options for organizing vials and other pharmacy supplies. Baskets nest when not in use.
- Smart Design - Mesh construction allows airflow and easy content identification.



Item #	Dimensions (W x H x D)
19921W A	6-11/16 x 2-3/4 x 9-13/16"



Tilters® Tilt Front Bins

- Modular bins – stack and customize to fit your storage and organization requirements
- Front opens at a 45 degree angle for easy access
- Clear fronts provide easy visual access to inventory
- Moulded in tough beige or white plastic (specify colour when ordering)

Item #	Overall Dimensions (W x H x D)	Compartment Dimensions (W x H x D)	# of Compartments per unit
1203A B	235/8 x 41/2 x 35/8"	3-1/8 x 2-3/4 x 2-5/8"	6
1205E C	235/8 x 61/2 x 51/4"	4 x 4-1/2 x 3-3/4"	5
1207E D	235/8 x 81/8 x 65/8"	5 x 5-1/4 x 5"	4
1210A E	235/8 x 91/2 x 73/4"	7-3/4 x 23-5/8 x 9-1/2"	3
1215 F	235/8 x 137/8 x 113/4"	11-7/8 x 23-5/8 x 13-7/8"	2
1213 G	113/16 x 137/8 x 113/4"	10-1/2 x 13-1/4 x 8-1/4"	1

High Alert Insulin Bin

- Includes one “Stop Potential Double Check” label and two “High alert Insulin” labels (additional labels sold separately – contact us for details)
- Distinct appearance differentiates the bin from other supply bins; therefore reducing potential medication errors during storage and dispensing
- Lid and labelling serve as a cue for the healthcare professional to read and verify before using
- Clear lid allows bin contents to remain visible
- Accommodates 10 packs of insulin vials
- Made out of PETG
- Can be cleaned with sterile alcohol 70% spray, Isopropyl Alcohol 99%, and Infection Control Surface Wipes, see page 100-101 for options and details



Item #	Outside Dimensions (W x H x D)
17261	4-1/8 x 4 x 10-7/8"



Rx Fill Tray

- Rx fill trays help keep individual prescription components together from arrival at the drug store to the prescription pick up counter
- Trays have easy-grip handles, nest when empty to save space
- Available in ● blue, ○ clear, ● green, ● red, ○ white and ● yellow - specify colour when ordering

Item #	Outside Dimensions (W x L x H)
17487	6-7/8 x 10-1/2 x 2-1/2"

Drawer Organizing Trays

- Organize supplies in carts, cabinets, on counters or use as exchange trays for anesthesia, treatment, medication and crash carts
- Includes dividers (additional dividers sold separately, see items below)
- Made of white high impact polystyrene plastic

Item #	Description	Outside Dimensions (L x W x H)
12560	A Tray with Dividers	15 x 10-3/4 x 2"
12561	B Tray with Dividers	15 x 10-3/4 x 3-1/2"
12562	Tray with Dividers	15 x 10-3/4 x 6"
12568	Tray Only (no dividers)	15 x 10-3/4 x 2"
12569	Tray Only (no dividers)	15 x 10-3/4 x 3-1/2"
12570	Tray Only (no dividers)	15 x 10-3/4 x 6"
12564	2" High Dividers, 2 long, 3 short (for #12568)	-
12565	3 1/2" High Dividers, 2 long, 3 short (for #12569)	-
12566	6" High Dividers, 2 long, 3 short (for #12570)	-



Tray & Divider System

- Create Infinite Configurations - Components allow users to neatly organize tray contents for fast, easy retrieval. Configurations can be rearranged with little effort to create limitless storage possibilities.
- Tray/Cart Compatibility - White plastic tray has a smooth interior and finger holes for easy placement inside crash cart drawers. It fits neatly inside a variety of units including the Metro® Flexline Crash Cart and the WAT-3 Crash Cart.
- Divide and Conquer - Clear acrylic dividers are scored every 1" for breakability. Determine the length needed, bend at the scored portion then snap the divider to size. When compartment size needs change, break new dividers to fit.
- Hold It Together - Clear plastic clips secure dividers in place

Item #	Description	Dimensions (L x W x H)	Quantity
20964	A Tray	19 $\frac{1}{8}$ x 2 $\frac{1}{2}$ x 15"	1
21089	Tray	20 $\frac{1}{2}$ x 2 $\frac{1}{2}$ x 16 $\frac{1}{2}$ "	1
21084	Tray	21 $\frac{1}{2}$ x 5 x 15 $\frac{1}{4}$ "	1
20980	Tray	22 x 2 $\frac{1}{2}$ x 16"	1
21083	Tray	22 $\frac{1}{2}$ x 3 $\frac{3}{4}$ x 12 $\frac{3}{4}$ "	1
21049	Divider Clips	$\frac{3}{4}$ "	50
21050	Scored Dividers	2-1/4"	10
21079	Scored Dividers	3 $\frac{1}{2}$ "	10
21081	B Scored Dividers	4 $\frac{3}{4}$ "	10
21051	Divider System	2-1/4"	10 Dividers & 50 Clips
21080	C Divider System	3 $\frac{1}{2}$ "	10 Dividers & 50 Clips
21082	Divider System	4 $\frac{3}{4}$ "	10 Dividers & 50 Clips





Two deep compartments for organizing supplies when transporting between departments and from floor to floor

Caddy has one pull-out drawer. Drawer contains 12 compartments



This carrier has four large compartments with removable dividers to organize phlebotomy supplies for quick retrieval



Features a set of two economical, disposable, compartmentalized inserts specifically designed for blood collection.

Includes: Sturdy plastic tray comes with its own 16mm test tube rack and two disposable Phlebotomy Tray Inserts

Resilient and durable carry caddies have one slide-out drawer. The drawer contains six compartments

Carry Caddies

- Use to transport supplies to and from the patient site and provides portable workstations - reduce trips to supply areas
- Resilient and durable carry caddies are made of high density polyethylene plastic
- **Note:** Height measurements below do not include handles

Item #	# of Compartments	Description	Outside Dimensions (W x H x D)
5228	A 2	Carry Caddy	15 x 4-7/8 x 10-7/8"
5231	B 2	Tote Caddy	18 x 5-1/2 x 14"
1828	C 12	Emergency Carry Caddy with Drawer	16-1/2 x 6-5/16 x 10-1/4"
5227	D 6	Carry Caddy with Drawer	15 x 7" x 9-1/4"
10318	E 4	Phlebotomy Supply Carrier with Removable Dividers	16-1/2 x 3-5/16 x 11-3/4"
17465	F 8	Phlebotomy Tray Includes 2 inserts (17746) and 5/8" Tube Rack	16-7/8 x 5-7/8 x 9-1/4"
17466	8	Phlebotomy Tray Inserts for 17465 (8 Compartments)	-

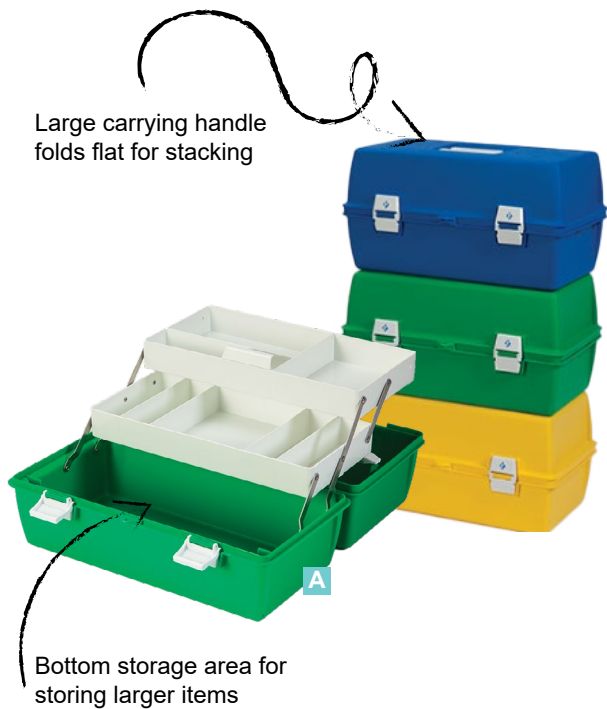

Large carrying handle folds flat for stacking

Bottom storage area for storing larger items

Handle folds down flush and box is stackable to save space

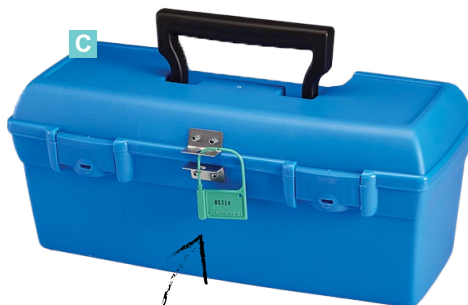

A padlock or security seal can be inserted in the security seal eyelets to make them tamper evident

Medical Supply Box

- Includes 2 cantilever trays, with 3 compartments on the top, and 5 compartments on the bottom
- Double latch closure ensures lid will stay securely closed while carrying
- Built-in security eyelet accepts security seals and small padlocks to make the box tamper-evident
- Made of durable polypropylene plastic
- Designate a colour for a particular use or department
- Available in ● blue, ● green, and ● yellow - specify colour when ordering



Twin top storage compartments have easy access lids

Item #	Dimensions (W x H x D)
17265 A	17-5/8 x 10-1/4 x 8-3/4"

Medical Supply Carrying Boxes

- Medical supply box ideal for storage and carrying various medication, patient procedure supplies, medical passes, exchanges, and many other storage uses
- Provides secure stacking on shelves or palettes
- Steel draw latch snaps tightly closed
- Models with built-in security eyelet accepts security seals and small padlocks to make the box tamper-evident (see security seal section for details)
- Made of industrial grade polymers



Two secure lock latches for added security

Item #	Description	Eyelet	Latch	Colour	Outside Dimensions (W x H x D)
1371 B	Medical Box	-	1	● ●	12 x 4 x 5-5/8"
1112	Box With Tray	-	2	● ●	13 x 6 x 5-1/2"
1113 C	Box With Tray	✓	2	● ●	13 x 6 x 5-1/2"
1499-01	Box With Lift Out Tray	✓	1	●	14 x 5-1/4 x 6-1/2"
18631	Box With Lift Out Tray	✓	1	●	20 x 9-3/4 x 9-1/4"
18630 D	Box With Lift Out Tray	✓	1	●	17 x 8-1/2 x 8-1/2"
18290 E	Box With Lift Out Tray	✓	1	●	23 x 10-1/2 x 11-3/8"

Plastic Utility Boxes

- Ideal for storing and organizing small supplies
- Additional dividers can be purchased (contact us for details)

Item #	Outside Dimensions (W x H x D)	Eyelet	# of Adjustable Dividers	Stationary Compartments
1600	3 x 1-1/4 x 4-5/8"	-	-	1
1601	A 3-3/4 x 1-1/4 x 7"	-	-	1
1602	4-1/8 x 1-7/16 x 7"	-	6	3
12555	B 9 x 2 x 7"	-	-	1
1582-01	C 10-7/8 x 1-3/4 x 7-1/2"	✓	12	5
1486	11 x 1-3/4 x 6-3/4"	-	12	6
1583-01	D 14 x 1-7/8 x 8-1/2"	✓	20	4
1477	E 14 x 2 x 9"	-	16	4
1488	14 x 2 x 9"	-	16	4
1599	14 x 3-3/4 x 9-1/8"	-	11	4
1585-01	14 x 3-3/4 x 9-1/8"	-	-	1

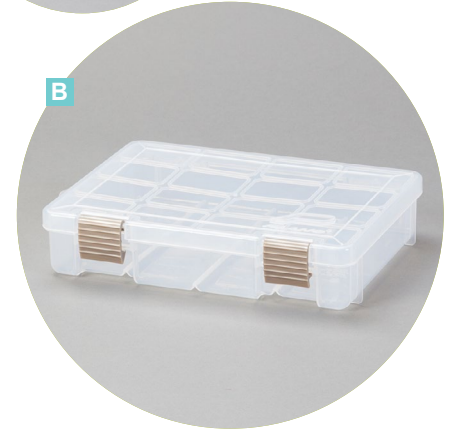

Customize Your Utility Box!

- Apply custom labels to help identify the contents in your box!
- Custom imprint your company logo, department, inventory details or storage instructions!
- Add drilled holes for security seals & padlocks
- Contact customer service today!

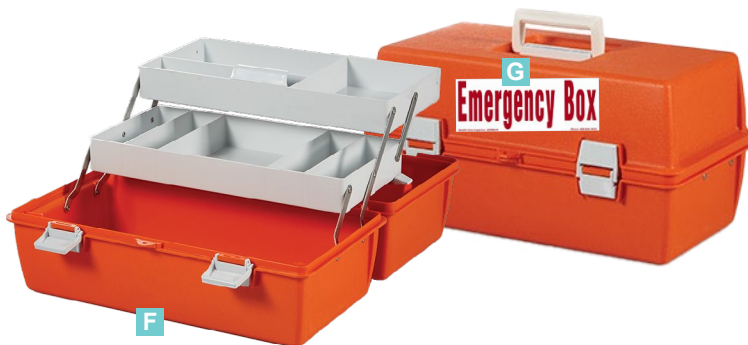

Emergency Boxes

- Two cantilever trays
- Built-in security eyelet accepts security seals and small padlocks to make the box tamper-evident

Item #	Description	Outside Dimensions (H x W x D)	# of Compartments
1800	F Emergency Box	8-3/4 x 17-5/8 x 10-1/4"	3 top/5 bottom
1802	Emergency Box	10-1/8 x 19 x 10-3/4"	5 top/5 bottom
2388-01	G Emergency Box Vinyl Label	6-1/8 x 2-1/4"	-

Self-Adhesive Pockets

- Adheres to almost any material
- Hold identification cards, instructions, dates, patient history, supply usage, etc
- Keep important material protected from dust, dirt, weather and visible for quick identification and access
- No need to have new labels printed each time information changes - simply update insert inside pocket



Item #	Size	Qty
1265	2-1/8 x 3-1/2"	6
1266	3-1/2 x 5-1/4"	6
1267	8 x 4"	5



Insulated Boxes

- Ideal for use as a disposable, mini lightweight cooler to transport and ship temperature-sensitive supplies!
- White cardboard box features a leak-resistant gusseted liner made from FDA-approved materials
- Liner's adhesive lip tape seals the contents for maximum protection
- Boxes are shipped flat with instructions for assembly on the bottom of each box

Item #	Outside Dimensions (W x H x D)	Qty
17878	8 x 8 x 8"	5

Tamper-Evident Boxes & Seals

- Maximize Storage - Tamper-evident boxes with lids allow easy viewing of contents for a convenient way to store, organize and access supplies.
- Stackable - Lid design allows boxes to stack. Sliding lid has a back-stop mechanism to prevent the lid from slipping off.
- Easy to Secure - Use with the consecutively numbered Tamper-Evident Box Seals (#18213, sold separately) to secure contents.

Item #	Description	Dimensions (W x H x D)	Qty
18212	A Tamper Evident Box, Large	5-7/8 x 3-11/16 x 2-7/8"	1
18211	B Tamper Evident Box, Small	3-7/8 x 1-3/4 x 2-7/8"	1
18213	C Tamper-Evident Box Seals	1-1/8 x 7/8"	25

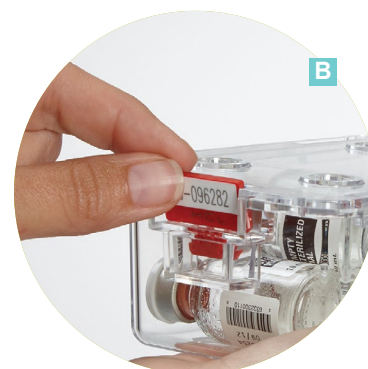
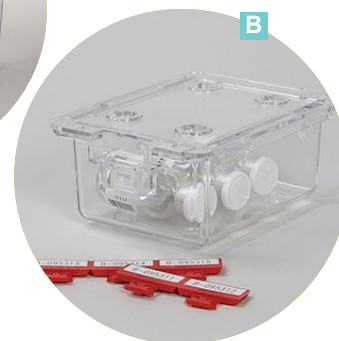
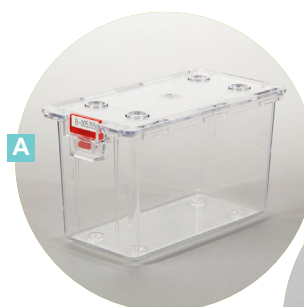



Briefcase Drug Boxes

- Made of heavy-duty dent-proof plastic that resists common odors and solvents
- See-through lids assure quick identification of contents
- Available with or without security seal eyelets & adjustable dividers
- Security seal eyelets allow boxes to be sealed for documenting control while deterring tampering

Item #	Description	Security Seal Eyelet	Outside Dimensions (W x H x D)
1822	A Briefcase Drug Box, No Dividers	-	15 x 2-1/2 x 11-3/4"
1820	B Briefcase Drug Box with 15 Removable Dividers Customize 9 To 24 Compartments	-	15 x 2-1/2 x 11-3/4"
1821	Briefcase Drug Box with 15 Removable Dividers Customize 9 To 24 Compartments	✓	15 x 2-1/2 x 11-3/4"
1832	Briefcase Drug Box, No Dividers	✓	15 x 2-1/2 x 11-3/4"
1825	C Large Briefcase Drug Box with 24 Removable Dividers & 7 Permanent Customize With 8 To 32 Compartments	-	18-1/2 x 3 x 13"
1831	Large Briefcase Drug Box with 24 Removable Dividers & 7 Permanent Customize With 8 To 32 Compartments	✓	18-1/2 x 3 x 13"
1804	D Foam For Briefcase Drug Box, Blue (Fits #1822)	-	-

Security Drug Cases & Drug Storage Cases

- Secure Transport - Plastic cases with high-strength hinges and sliding positive lock latches with security seal eyelets. 1 or both latches can be locked with a security seal or small padlock.
- Seals sold separately. 2 cam locks on the 1453K case keep narcotics and other drug and emergency kits secure.
- Removable Foam - Liner (all except 1584K) protects vials, ampules, syringes and other supplies during transport.

Item #	Description	Dimensions (W x H x D)
1452K	E Security Drug Case with Removable Foam Liner	1-31/4 x 3 x 10"
1453K	Security Drug Case with 2 Key Locks	13-9/16 x 3 x 10-1/8"
1584K	F Drug Storage Case without Foam	10-1/2 x 3-1/8 x 8"
1573K	Drug Storage Case without Foam	14 x 3-1/4 x 11"



Pull Tight Seals

- Self-locking seal for easy application and removal – no tools required for removal
- Printable area – textured side ideal for writing
- Made out of polypropylene plastic, autoclavable up to 163°C
- Seal length: 9", tail length: 7", width: 1/16"
- **Average Breaking Strength: 11-14 lbs.**
- 100 per package

Item #	Description	Colour
7820	Pull Tight Security Seals, Consecutively Numbered	● Red
7813	Pull Tight Security Seals, Consecutively Numbered	● Yellow
7817	Pull Tight Security Seals, Consecutively Numbered	● Green
7816	Pull Tight Security Seals, Consecutively Numbered	● Light Blue
7814	Pull Tight Security Seals, Consecutively Numbered	○ White
7930	Pull Tight Security Seals, Consecutively Numbered	● Purple
7821	Pull Tight Security Seals, Unnumbered	● Red
7823	Pull Tight Security Seals, Unnumbered	● Yellow
7825	Pull Tight Security Seals, Unnumbered	● Green
7827	Pull Tight Security Seals, Unnumbered	● Blue
7828	Pull Tight Security Seals, Unnumbered	○ White
7931	Pull Tight Security Seals, Unnumbered	● Purple
7829	Pull Tight Security Seals, Unnumbered	● Orange "Biohazard"

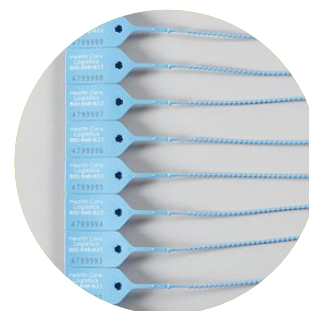

Numbered



Unnumbered

Pull Tight Baby Seals

- Self-locking seal for easy application and removal – no tools required for removal
- Smaller tail is ideal for securing tighter gaps and spaces
- Printable area – textured side of seal ideal for writing
- Made out of polypropylene plastic, autoclavable up to 163°C
- Seal length: 5", tail length: 4 3/8", width: 1/16"
- **Average Breaking Strength: 10.5 lbs.**
- 100 per package



Numbered



Unnumbered

Item #	Description	Colour
7923	Small Pull Tight Seals, Consecutively Numbered	● Red
7926	Small Pull Tight Seals, Consecutively Numbered	● Yellow
7917	Small Pull Tight Seals, Consecutively Numbered	● Green
7924	Small Pull Tight Seals, Consecutively Numbered	● Blue
7925	Small Pull Tight Seals, Consecutively Numbered	○ White
7928	Small Pull Tight Seals, Consecutively Numbered	● Orange
7904	Small Pull Tight Seals, Unnumbered	● Red
7915	Small Pull Tight Seals, Unnumbered	● Yellow
7902	Small Pull Tight Seals, Unnumbered	● Green
7905	Small Pull Tight Seals, Unnumbered	● Blue
7929	Small Pull Tight Seals, Unnumbered	○ White
7927	Small Pull Tight Seals, Unnumbered	● Orange

Ring Pull Seals

- Unique self-locking ring-shaped seal for easy application and removal
- Allows quick access (no tools required for removal)
- Double-wall locking chamber secures seal, while providing tamper-evidence
- Ring shape ideal for securing boxes and carts
- Printable area – textured side ideal for writing
- Consecutively numbered seals for tracking and inventory control
- Polypropylene plastic, autoclavable up to 163°C
- Seal length: 9¼", seal tail length: 8", width: ¼"
- **Average Breaking Strength: 23 lbs.**
- 100 per package

Item #	Colour
8120	● Red
8121	● Yellow
8122	● Green
8123	● Blue
8124	● Orange
8125	○ White
8126	● Grey
8127	● Black

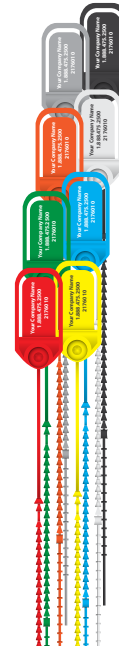

Pull Tight Padlock Seals

- Combination of "pull tight" easy-adjust seal and the "padlock" style locking mechanism
- Blank seals – can be written on with permanent marker to identify contents, date, time, initials, etc.
- Polypropylene, autoclavable up to 117°C
- Seal length: 7¾", seal tail length: 6", width: ¼"
- **Average Breaking Strength: 12.5 lbs.**
- 100 per package

Item #	Colour
7800	● Black
7801	● Green
7808	● Red
7809	● Blue
7810	○ White
7811	● Yellow

Safety Control Seals

- Padlock-style locking arrow ideal for narrow slot openings (approximately 0.093" thick)
- One-piece plastic seal is easy to apply and break (simply pull to break)
- Blank 1" base – apply custom labelling
- 100 per package

Item #	Colour
4108-1	● Red
4108-2	● Blue



Heavy Duty Pull Tight Seals

- Self-locking seal for easy application
- Heavy-duty seal provides security
- Requires scissors or knife for removal
- Consecutively numbered seals for tracking and inventory control
- Printable area – textured side of seal ideal for writing
- Made out of polypropylene plastic, autoclavable up to 163°C
- Seal Length: 9½”
- Seal Tail Length: 7⅞”
- Width: Approximately ¼”
- **Average Breaking Strength: 35 lbs.**
- 100 per package

Item #	Colour
7843-10	● Red
7845-10	● Blue

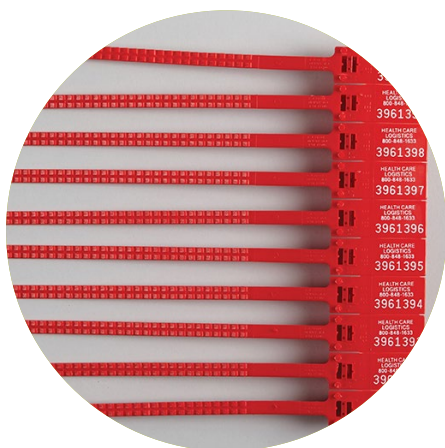

Extra Heavy Duty Pull Tight Seals

- Self-locking seal for easy application
- Heavy-duty seal provides security
- Requires scissors or knife for removal
- Consecutively numbered seals for tracking and inventory control
- Printable area – textured side of seal ideal for writing
- Made out of polypropylene plastic, autoclavable up to 163°C
- Seal Length: 13½”
- Seal Tail Length: 10¾”
- Width: Approximately ¼”
- **Average Breaking Strength: 110 lbs.**
- 100 per package

Item #	Colour
7831	● Red
7830	● Blue
8186-10	● Green
8185-10	● Yellow
7853-10	● Black

Padlock Seals

- Self-locking – no tools required for application or removal
- Spring-lock design will automatically open if not properly closed
- Simply twist to open
- Seals are numbered (not sequentially)
- Made out of polypropylene plastic, autoclavable up to 163°C
- Measures: 1.5” W x 1.875” H, width: 0.0625”
- **Average Breaking Strength: 8 lbs.**
- 100 per package

Item #	Colour
7901	● Red
7903	● Yellow
7906	● Blue
7910	○ White
7912	● Green
7914	● Purple



Extra Heavy Duty Blank Padlock Seals

- Extra-heavy duty strength provides security – cutting is recommended for removal
- Select from blank seals or consecutively numbered seals
- Polypropylene plastic, autoclavable up to 117°C
- Measures: 7/8" W x 1 3/8" H
- **Average Breaking Strength: 35 lbs.**
- 100 per package

Item #	Colour
7802	● Red
7803	● Green
7804	● Yellow
7818	A ● Orange



Easy Pull-Tight Seals, Numbered

- Average breaking strength: 11-14 lbs
- Tamper-Evident: One-piece, pull-tight, adjustable seal is designed to enhance safety by showing evidence of tampering
- Available in a variety of colours
- 100 per package
- Dimensions:
Seal length - 8"
Tail length - 7 9/16"

Item #	Description
18319	B Numbered
18320	Unnumbered

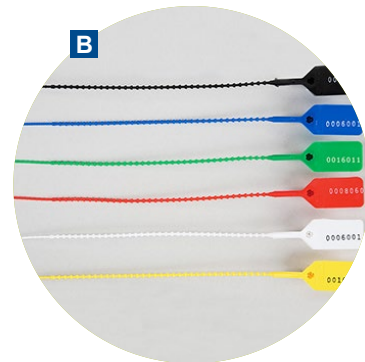

Twin Tote Seals , 7"

- Security - Totes require two seals to be properly secured, the Twin Tote Seal is always manufactured in sequential "twin" sets with identical numbers.
- Average breaking strength - 45 lb.
- Quantity: 200/pack

Item #	Description
17472	C Numbered

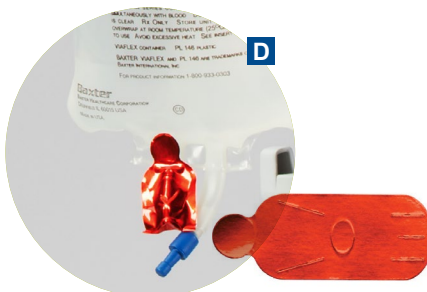

Bag Port Seals

- Sterile seals protect the point of entry of IV admixtures from contamination and accidental double dosing
- Seals self-destruct upon attempted removal to show evidence of tampering
- Smart choice for USP compliance
- Specify colour when ordering, see details below
- Packaged in a dispensing box, 1000 per package



Item #	Description
7893	D For Baxter's Vialflex & Mini-Bag Plus Containers Colours: ● blue, ● green, ● red, ● yellow
5315	E For Abbott's Large Bags & ADD-Vantage System
5316	F For McGaw's Excel Bags & Abbott's Small Bags Colours: ● red, ● blue, ● green Tamper Resistant Add-Port Caps

Steri-Tamp® Sterile Tamper Evident Seals

- The only tamper evident seal that provides a 100% sterile barrier
- Protects against contamination and accidental double dosing
- Alerts staff when a drug has been added
- Patented dual-layer leaves true tamper evidence with "Opened" labelling left behind
- The foil top layer provides evidence of needle puncture
- Allows pharmacy to recycle medication and protects patients from dosing errors
- Maintains adhesion, even when refrigerated or frozen in cold drug storage conditions
- Packaged in easy-to-use dispensers



Steri-Tamp® Tamper Evident Vial Seals

- Barrier Protection - Protects Against Contamination and Accidental Double Dosing. Identify if a previously opened vial or IV bottle has been tampered with
- Single Use - Gamma sterilized and intended for single use. The target area remains sterile until removed from the liner
- Tamper Evident - Foil outer layer provides visible evidence of a needle puncture. Leaves a printed "OPENED" warning and cannot be reapplied.
- Refrigerator Safe - Seals maintain adhesion when refrigerated or frozen in cold drug storage conditions
- Convenient Packaging - Packaged in a plastic clamshell container with hanging tab for dispensing
- **Note:** For use with vials only

Item #	Size	Colour	Qty
18297	A 13 mm	Red	1000
18298	B 20 mm	Chrome	1000
18299	C 28 mm	Blue	1000



Steri-Tamp® IV Bag Belly Button Port Seal

- Sterile Barrier - Maintains a 100% sterile barrier if properly applied. Notches allow seal to lay flat to prevent bacteria from channeling to the port.
- Features a lint-free plastic liner that will not shed particulate – USP 797 compliant

Item #	Size	Colour	Qty
18502	D 13 mm	Green	1000

Steri-Tamp® IV Bag Port Seals

- Sterile Barrier - Maintains a sterile barrier if properly applied.
- Refrigerator Safe - Seals maintain adhesion when refrigerated or frozen in cold drug storage conditions.
- USP <797> Friendly - Seals feature a lint-free plastic liner and are packaged in a plastic clamshell dispensing container that will not shed particulate.
- Protects the point of entry of IV admixtures from contamination and accidental double dosing
- Yellow seal marked "CHEMO"

Item #	Size	Colour	Qty
18296R	1-1/4 x 2"	Red	1000
18296B	A 1-1/4 x 2"	Blue	1000
18695	B 1-1/4 x 2"	Yellow	1000

Tamper Evident Vial Seals

- Offers a reliable moisture, particulate and bacterial barrier when properly applied
- Punctures are highly visible in laminated foil
- Adhesive allows application prior to freezing or refrigeration
- Surface material remains sterile until removed from the paper backing
- Latex free
- Specify colour: ● blue, ● green, ● yellow, or ● red
- Packaged in an easy dispensing box

Item #	For Vial Top Size	For Vials with a capacity of:	Qty
7866	13 mm	2 mL, 5 mL, 10 mL, 20 mL	1100
7867	C 20 mm	30 mL	1000
7887	28 mm	30 mL	1000
7885	36 mm	30 mL	1000

Tamper Evident Seals with Pre-Printed Messages

- Tamper-Evident - Seals are preprinted with a chemotherapy message to quickly identify contents in bags, syringes, vials and bottles
- Sterile Barrier - When applied properly surface remains sterile until removed from the backing
- Single Use - Needle punctures are highly visible and the seals cannot be reapplied once removed
- Accommodates 28 mm bottle tops
- Packaged in a dispensing box, 1000 per package

Item #	Description	Qty
7990	D Chemotherapy Bag Port Seal	1000

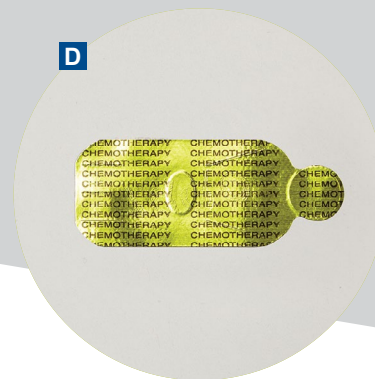

Tamper Evident Oral Tip Caps

- Three-part plastic cap for Baxa ExactaMed Oral dispensers
- Secure, non-sterile cap requires user to break off outer sleeve in order to dispense medication
- Tamper-indicating red ring remains in place, indicating outer sleeve has been removed
- Cap is made of polypropylene, sleeve of polystyrene plastic
- Latex free

Item #	Qty
52300	100



Tamper-Evident Luer Lock Tip Caps

- Three-part plastic cap used to indicate tampering on a luer lock syringe
- Sterile and non-pyrogenic in unopened, undamaged package
- Latex free

Item #	Qty
64010	100 (Trays of 10)

Tamper Indicating Seals

- Silver foil tamper indicating seals
- Ideal for syringes (plungers or caps), prescription bottles, small ointment tubes, screw top vials, etc.
- Latex free
- Measures: 1 3/4" x 3/4"
- Packaged in a dispensing box

Item #	Qty
30020	1000



Tamper Evident Tape Strips

- Compatible - Pre-printed tape strips adhere to boxes, specimen vials, and other hard to secure items in order to show tampering once ripped
- Tape reads - Integrity Seal, Sealed by and Date.
- Each strip measures 6 $\frac{5}{8}$ " x 1 $\frac{1}{8}$ "

Item #	Qty
12281	100



Tamper Indicating Seals

- Security Message - Laminated label reveals a prominent VOID/OPEN security message when lifted. Choose Residue (7957) or No Residue (7958).
- Numbered - For traceability
- Quantity - 250 per roll

Item #	Description	Colour	Dimensions (W x H)
7958R	No residue	Red	23/16 x 3/4"
7958B	No residue	Blue	23/16 x 3/4"
7957R	Residue	Red	33/8 x 1"
7957B	Residue	Blue	33/8 x 1"

Tamper Resistant Tape

- Ideal for hard to secure items such as jar tops, bottle caps, syringes, vials, etc.
- Tape molds easily to any item
- Pre-printed in black
- Packaged in an easy-dispensing box

Item #	Width	Length	Qty	Colour
8005	A 2"	164 Feet	1 roll	Red
8000	B 1/2"	108 Feet	2 rolls	Red
8002	C 1/2"	108 Feet	2 rolls	Clear
8006	D 1"	108 Feet	1 roll	Red
8008	E 1/2"	108 Feet	2 rolls	Red
19703	F 1/2"	50 Feet	1 roll	Yellow
19027	G 1/2"	50 Feet	1 roll	Blue
8007	H 1"	108 Feet	1 roll	Red
8009	I 1/2"	108 Feet	2 Rolls	Orange

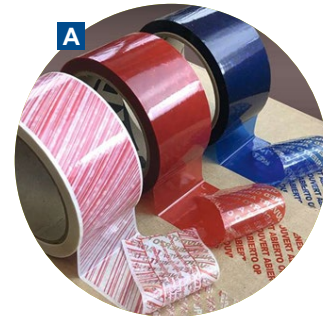

TAMPER RESISTANT TAPE **B**

TAMPER RESISTANT TAPE **C**

TAMPER RESISTANT TAPE **D**

MPER TAMPER TAMPER TAMI **E**

HAZARDOUS HAZARDOUS HA **F**

SINGLE PATIENT USE **G**

INVIOLEABLE INVIOLEAB **H**

RUBAN INVIOLEABLE **I**



French Tamper Tape

Steri-Tamp® Syringe Seal

- Non-sterile solution to provide tamper evidence and helps prevent risk of double dosing
- Metalized polyester seal rips apart to show tampering
- Maintains adhesion when refrigerated or frozen in cold drug storage conditions
- Smart choice for USP compliance
- Packaged in a dispensing box



Item #	Colour	Length	Qty
18853	Red	4-1/4"	1000

Syringe Seals

- Multi-Use - Non-sterile seals can be used on all syringes, vials, boxes, otic/ophthalmic containers, etc.
- Molds Easily - Flexible foil seals attach to syringe caps or sheaths. Cannot be reapplied once removed. Non-sterile solution to provide tamper evidence and help prevent risk of double dosing
- Foil material wrinkles or tears upon removal to show tampering
- Smart choice for USP compliance
- Packaged in a dispensing box



Item #	Colour	Length	Qty
7868Y	A Yellow	4-1/4"	1000
7868R	B Red	4-1/4"	1000

Tamper Evident Syringe Seals with Pre-Printed Messages

- Pre-printed with "Do Not Use if Seal Is Broken" in red
- Cannot be re-attached once removed
- Packaged in a dispensing box

Item #	Colour	Size	Length	Qty
7997	C Silver	Short	3-5/8"	1000
7998	D Silver	Long	4-1/4"	1000
8001	E White	Short	3-1/2"	1000

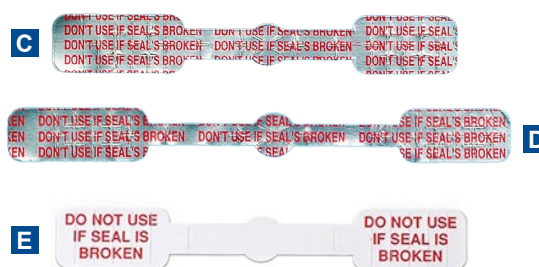

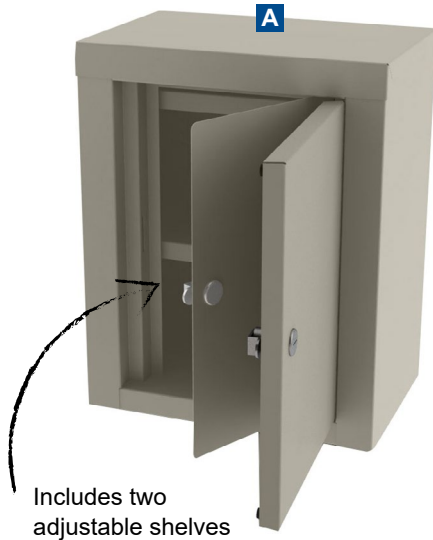

Narcotic Cabinets

Item #	Description	Steel	# of Doors	Locks per Door	Total # of Locks	# of Shelves	Dimensions		
							Width	Height	Depth
3700	A Small Double Door	20 gauge	2	1	2	2 adjustable	12-1/8"	15"	8-1/8"
3705	B Large Double Door	20 gauge	2	1	2	3 adjustable	18-1/8"	24"	12-1/8"
3780	C Small Single Door	20 gauge	1	2	2	1 adjustable	14"	12"	8"
3772	D Single Door, Single Lock	18 gauge	1	1	1	3 (1 fixed, 2 adjustable)	24"	30"	10"
3782	E Single Door, Double Lock	18 gauge	1	2	2	3 (1 fixed, 2 adjustable)	24"	30"	10"
3704	F Double Door, Double Lock	20 gauge	2	1	2	1 fixed	12"	15"	8"
3886	G Double Door, Double Lock	20 gauge	2	1	2	3 adjustable	18"	30"	8"
3708	H Large Locking Cabinet	20 gauge	1	1	1	1 fixed, 1 adjustable	30"	30"	12"
3761-01	I Compact Security Cabinet	20 gauge	1	2	2	-	7-1/4"	8-3/4"	6"
3706-01	J Slim Security Cabinet	20 gauge	1	2	2	2 fixed	8"	12-1/8"	2-3/8"
20323	K Double Door, Double Lock	20 gauge	2	1	2	1 adjustable	12"	16"	9"
20324	L Double Door, Double Lock	20 gauge	2	1	2	2 adjustable	16"	24"	8"



Double walled door



Cabinets are keyed differently with two keys per lock



Includes one fixed shelf & two adjustable shelves

Cabinet with handle is ideal for small spaces



Includes two fixed shelves



Includes one adjustable shelf



Includes two adjustable shelves

Narcotic Cabinet Features:

- Piano hinge prevents pin removal
- Predrilled holes for mounting
- Contact our customer service team to find out about additional keying options and making duplicates from your original key!

View all narcotic cabinets and accessories here!



Four digit code required to access contents



Keyless Entry Digital Lock (first door only; key lock on second door)

Keyless entry digital lock allows staff to secure drugs without needing extra keys. Lock can be programmed with multiple user codes to prevent unauthorized access.



Keyless Entry Digital Lock Narcotic Cabinets

Item #	Description	Steel	# of Doors	Keyless entry digital lock	# of Shelves	Dimensions		
						Width	Height	Depth
17846	A Security Cabinet, KEDL	18 gauge	1	✓	3 (1 fixed, 2 adjustable)	2-41/8"	30"	10-1/16"
19948	B Security Cabinet, KEDL with Audit Trail	20 gauge	2	✓ and lock	3 adjustable	18"	30"	8"
20397	C Slim Security Cabinet, KEDL	20 gauge	1	✓	2 fixed	8"	12-1/8"	2-3/8"

Locking Key Storage Boxes

- Secure Storage - Mount to any flat surface to keep keys locked but accessible using a push-button combination.
- Heavy Duty - Made of rustproof zinc alloy metal.

Item #	Capacity	Dimensions (W x H x D)
10430	A 2-key	2-1/4 x 3-7/8 x 1-5/8"
10431	B 5-key	2-1/2 x 4 1/8 x 1-7/8"
10432	C Keys & Credit-Card Style Storage	3-1/2 x 4-3/4 x 2-3/4"



Lockable Storage Cabinet

- Secure Storage - Lockable steel cabinet keeps sensitive drugs secure. Includes four adjustable shelves and a key lock with two keys
- Organize Supplies - Sort items inside bins or supply drawers (not included) for quick, easy retrieval
- Wall-Mount - Powder-coated storage locker mounts to the wall for convenient access in a consistent location

Item #	Dimensions (W x H x D)
20150	D 19-1/4 x 38 x 15-1/8"

Briefcase Drug Boxes

- Boxes are an excellent way to customize drug and supply kits for exchanges, emergency room and ambulance use.
- Comes with 15 removable dividers. Customize with 9 to 24 compartments.
- Dimensions: 15"W x 2 1/2"H x 11 3/4"D

Item #	Description
1820	E Briefcase drug box w/ 15 removable dividers
1821	Briefcase drug box w/ security seal holes
1822	Briefcase drug box, no dividers or security seal holes
1832	Briefcase drug box w/ security seal holes, no dividers



View all Briefcase Drug Boxes on page 50.

Custom Sizes & Printing Available!

Customize the following:

- Size: Most of the blank bags offered can be custom imprinted
- Quantity: 500 bag minimum
- Imprint Area: Select from 1¼ x 3½", 3½ x 3½" & 4 x 4"
- Imprint Colour: Select from black, blue, green, orange, pink, purple, red, yellow or white text
- Message: Add text or symbols

Contact us for details or to place your order!



Clear Zip It Bags, Regular Strength

- Resealable poly bags with a single track zipper closure
- Latex free
- 2 mil thick

Item #	Size	Qty
MG2X2	2 x 2"	1000
MG2X3	2 x 3"	1000
MG2X8	2 x 8"	1000
MG3X3	3 x 3"	1000
MG3X4	3 x 4"	1000
MG3X5	3 x 5"	1000
7521	3 x 12"	100
MG3X12	3 x 12"	1000
MG4X4	4 x 4"	1000
MG4X6	4 x 6"	1000
MG4X8	4 x 8"	1000
MG5X7	5 x 7"	1000
MG6X4	6 x 4"	1000
MG6X6	6 x 6"	1000
MG6X8	6 x 8"	1000
MG6X9	6 x 9"	1000
MG6X10	6 x 10"	1000
MG8X8	8 x 8"	1000
MG8X10	8 x 10"	1000
MG10X10	10 x 10"	1000
MG9X12	9 x 12"	1000
MG10X12	10 x 12"	1000
MG10X13	10 x 13"	1000
MG12X12	12 x 12"	1000
MG12X15	12 x 15"	1000
MG13X15	13 x 15"	1000
MG13X18	13 x 18"	1000



Can be used to package, dispense or store almost any item

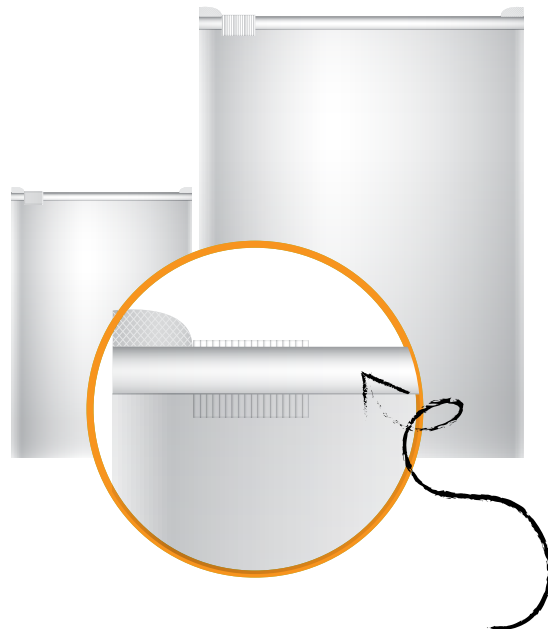

Double track zippers provide added strength and durability

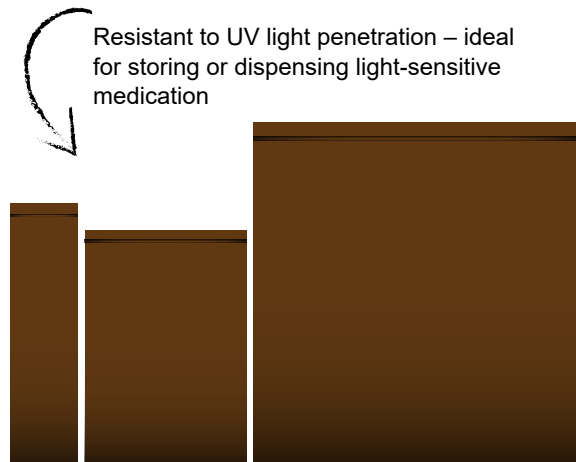

Poly Bags

Resealable Bags

- Latex free

Item #	Description	Zipper	UV Resistant	Size	Thickness	Qty
M4G3X4	Clear Zip It Bags, Resealable	Single	-	3 x 4"	4 mil	1000
M4G3X5	Clear Zip It Bags, Resealable	Single	-	3 x 5"	4 mil	1000
M4G4X4	Clear Zip It Bags, Resealable	Single	-	4 x 4"	4 mil	1000
M4G4X6	Clear Zip It Bags, Resealable	Single	-	4 x 6"	4 mil	1000
M4G5X8	Clear Zip It Bags, Resealable	Single	-	5 x 8"	4 mil	1000
M4G6X6	Clear Zip It Bags, Resealable	Single	-	6 x 6"	4 mil	1000
M4G6X9	Clear Zip It Bags, Resealable	Single	-	6 x 9"	4 mil	1000
M4G8X10	Clear Zip It Bags, Resealable	Single	-	8 x 10"	4 mil	1000
M4G9X12	Clear Zip It Bags, Resealable	Single	-	9 x 12"	4 mil	1000
M4G10X10	Clear Zip It Bags, Resealable	Single	-	10 x 10"	4 mil	1000
M4G10X13	Clear Zip It Bags, Resealable	Single	-	10 x 13"	4 mil	1000
M4G12X12	Clear Zip It Bags, Resealable	Single	-	12 x 12"	4 mil	1000
M4G12X15	Clear Zip It Bags, Resealable	Single	-	12 x 15"	4 mil	1000
M4G13X18	Clear Zip It Bags, Resealable	Single	-	13 x 18"	4 mil	1000
7567M	Amber Zip It Bags, Resealable	Single	✓	2.5 x 9"	3 mil	1000
7570M	Amber Zip It Bags, Resealable	Single	✓	3 x 5"	3 mil	1000
7573M	Amber Zip It Bags, Resealable	Single	✓	4 x 6"	3 mil	1000
7575M	Amber Zip It Bags, Resealable	Single	✓	6 x 8"	3 mil	1000
7576M	Amber Zip It Bags, Resealable	Single	✓	8 x 8"	3 mil	1000
7588M	Amber Zip It Bags, Resealable	Single	✓	8 x 14"	3 mil	1000
7578M	Amber Zip It Bags, Resealable	Single	✓	12 x 12"	3 mil	1000
10811	Clear Slider Bags, Resealable	Double	-	7 x 9"	2 mil	100
10812	Clear Slider Bags, Resealable	Double	-	8 X 10"	2 mil	100
10813	Clear Slider Bags, Resealable	Double	-	9 X 12"	2 mil	100
10814	Clear Slider Bags, Resealable	Double	-	10 x 12"	2 mil	100
10815	Clear Slider Bags, Resealable	Double	-	12 x 15"	2 mil	100

Non-reclosable - secure closed using a Heat Sealer

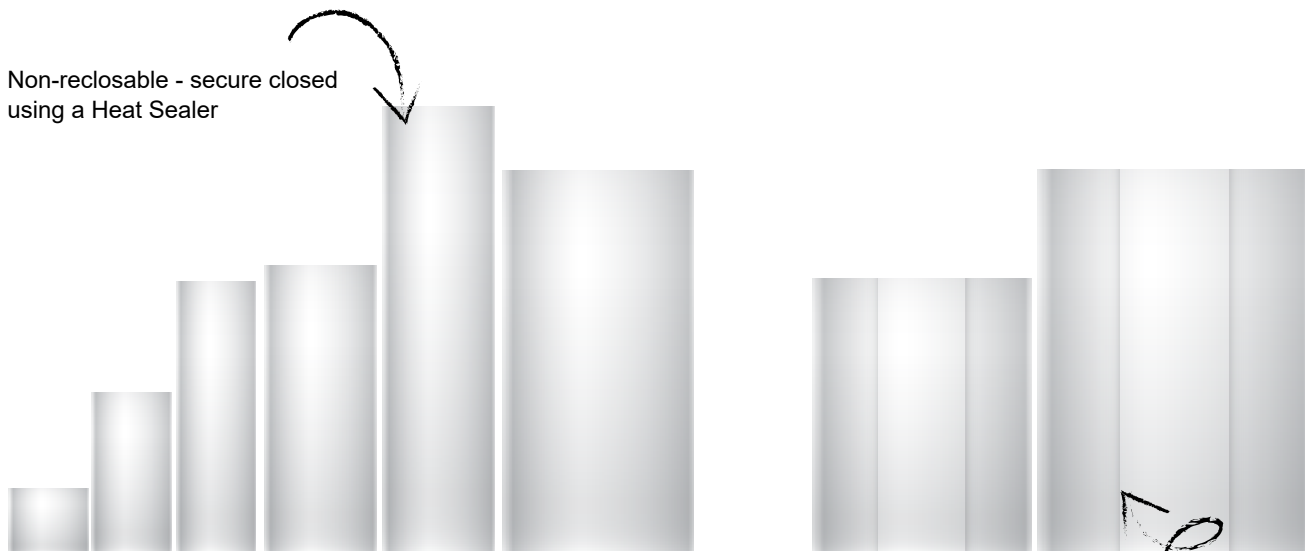

Extra room for large and irregular shaped items
Side gussets expand for an increased capacity and to provide a better fit for items

Non-Reclosable Bags

Item #	Description	Size	Qty
MP-410-22	Poly Bags for Tablets, Non-Reclosable	2-1/2 x 2"	1000
MP-410-25	Poly Bags for Large Ampules, Non-Reclosable	2-1/2 x 5"	1000
MP-410-28	Poly Bags for Syringes, Non-Reclosable	2-1/2 x 8-1/2"	1000
BPB3X9	Block Poly Bags for Syringes, Non-Reclosable	3-1/2 x 9"	1000
BPB314	Blocked Poly Bags, Non-Reclosable	3-1/2 x 14"	1000
PB6X12	Poly Bags, Non-Reclosable	6 x 12 "	1000
7652	Poly Bags, Non-Reclosable	3 x 5"	100
7654	Poly Bags, Non-Reclosable	4 x 6"	100
7656	Poly Bags, Non-Reclosable	6 x 9"	100
GB141022	Gusseted Bags, Non-Reclosable	14 x 10 x 22"	1000
GB10824	Gusseted Bags, Non-Reclosable	10 x 8 x 24"	1000
GB4212	Gusseted Bags, Non-Reclosable	4 x 2 x 12"	2000
GB6315	Gusseted Bags, Non-Reclosable	6 x 3 x 15"	1000
GB1218	Gusseted Bags, Non-Reclosable	12 x 18"	1000

Heat Sealers

- Heat sealer for plastic to ensure water-tight and air-tight seal
- Effective for autoclaving and heat sealing procedures
- Ideal for use with poly bags - can be customized to the desired length
- Ideal for packaging
- Can be used with most plastic materials (up to 0.2mm or 6 mil thick); including: polyethylene, polyurethane, polyvinylchloride, polypropylene, pliofilm, kel-f, polyflex, mylar, P.V.A., tivac, saran, and nylon
- Requires 110V outlet
- 3 prong grounded plugs
- Front of each sealer has a control knob that allows easy temperature adjustment and an indicator light to show when the sealer is ready to use
- Package includes: 1 heat sealer, 1 heating wire, 1 upper cloth
- Replacement parts available separately (select from full kit, or purchase parts individually, see below)



Item #	Size
HS200	8" Heat Sealer
HS300	12" Heat Sealer

Heat Sealer	Description	For use
MP-200	HS200 Replacement Kit Includes: Glass Tape, Pressure Pad Cover & Flat Wire	HS200
MP-300	HS300 Replacement Kit Includes: Glass Tape, Pressure Pad Cover & Flat Wire	HS300
MP-21011-12	Glass Tape (.5"W)	HS300
MP-21042-8	Pressure Pad Cover	HS200
MP-21042-12	Pressure Pad Cover	HS300
MP-21039-8	Element Wire (Flat)	HS200
MP-21039-12	Element Wire (Flat)	HS300
MP-21039A-8	Element wire (Round)	HS200
MP-21039A-12	Element wire (Round)	HS300
MP-2106-8	Teflon Cover (11/2"W)	HS200
MP-2106-12	Teflon Cover (11/2"W)	HS300

Tablet Crusher & Pouches

- Clear plastic pouches safely contains pills during crushing process, eliminating cross contamination and unnecessary clean up
- Latex-free
- 7 mil thick polyethylene

Item #	Description	Qty
7414-31	Pouches, 2" x 4-3/4"	1000
7414-10	Pouches, 2" x 4-3/4"	100
7424-01	Silent Knight® 10-1/2 x 3 x 4-1/2"	1



Silent Knight®

- Quiet and powerful pill crusher - silently crushes tablets without disturbing patients
- Ideal for use during night or early morning shifts
- Features OxiTitan™ antimicrobial coating to help fight infections
- Can be cleaned with any disinfecting cleaner
- Crushes pills and tablets into fine powder- reduces risk of clogging feeding tubes
- Requires minimum force to crush tablets, reducing risk of wrist or arm injuries
- Storage compartment provides easy access to pouches

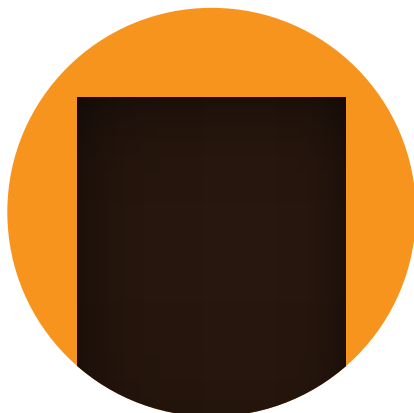

AMBER IS UV
PROTECTED!

UV Bags

- Ideal for light-sensitive medication and IV's
- Amber bags absorb 92% to 98% of light in the UV range
- Labels can be read through amber bags, eliminating the need for double labelling
- Latex free
- 2 mil thick

Item #	Description	Size (L x H)	Qty
ST-320-57	Slit-Top UV Bags For Piggyback IVs (250 mL)	5 x 8.5"	500
ST-320-60	Slit-Top UV Bags For 1/2-Liter IV Bags (500 mL)	6 x 10"	1000
ST-320-64	Slit-Top UV Bags For 1-Liter IV Bags (1000 mL)	6 x 14"	1000
ST-320-84D	Slit-Top UV Bags For 1-Liter IV Bottles (1000 mL)	8 x 14"	500
ST-320-84M	Slit-Top UV Bags For 1-Liter IV Bottles (1000 mL)	8 x 14"	1000
ST-320-108	Slit-Top UV Bags For 3-Liter IV Bags (3000 mL)	10 x 18"	250
ST-320-128	Slit-Top UV Bags For 4-Liter IV Bags (4000 mL)	12 x 18"	250
MP-320-22	Regular UV Bags For Tablets	2.5 x 2"	1000
MP-320-25	Regular UV Bags For Large Ampules	2.5 x 5"	1000
MP-320-28	Regular UV Bags For Syringes	2.5 x 8.5"	1000
MP-320-314	Regular UV Bags For Large Syringes	3 x 14"	1000
MP-320-57	Regular UV Bags For Piggyback IVs (250 mL)	5 x 8.5"	500
MP-320-60	Regular UV Bags For 1/2-Liter IV Bags (500 mL)	6 x 10"	1000
MP-320-64	Regular UV Bags For 1-Liter IV Bags (1000 mL)	6 x 14"	1000
MP-320-84D	Regular UV Bags For 1-Liter IV Bottles (1000 mL)	8 x 14"	500
MP-320-84M	Regular UV Bags For 1-Liter IV Bottles (1000 mL)	8 x 14"	1000
MP-320-108	Regular UV Bags For 3-Liter IV Bags (3000 mL)	10 x 18"	250
MP-320-128	Regular UV Bags For 4-Liter IV Bags (4000 mL)	12 x 18"	250
AUZ35	UV-Zip Reclosable Zipper Bags	3 x 5"	500
AUZ39	UV-Zip Reclosable Zipper Bags	3 x 9"	500
AUZ46	UV-Zip Reclosable Zipper Bags	4 x 6"	1000
AUZ58	UV-Zip Reclosable Zipper Bags	5 x 8"	500
AUZ69	UV-Zip Reclosable Zipper Bags	6 x 9"	500
AUZ814	UV-Zip Reclosable Zipper Bags	8 x 14"	500
AUZ912	UV-Zip Reclosable Zipper Bags	9 x 12"	500

IV tubing Covers extends the effectiveness of UVLI bags by protecting or binding the drug all the way to the patient!



Poly Bags

Opacity Chart

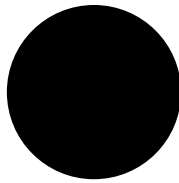

Dark

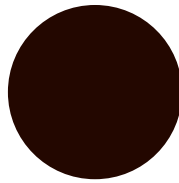

Medium

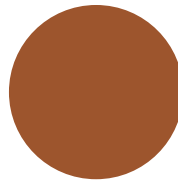

Light

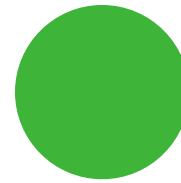

Green

IV Covers & Bags

- Ideal for dispensing and covering IV admixtures that contain light sensitive medication
- Amber protects IV tubing from exposure to light

Item #	Description	Tint	Size	Qty
7617	IV Tubing Cover	Amber	2-1/2 x 72"	10 strips
590-UT300	IV Tubing Cover	Amber	2-1/2 x 300'	1 Roll
590-UT1000	IV Tubing Cover	Amber	2-1/2 x 1000'	1 Roll
590-UT	IV Tubing Cover	Amber	2-1/2 x 2500'	1 Roll

Easy Write Zip It Bags

- Write-on Area - Designed with a white write-on block for writing text
- Small Package Quantities - Allows bags to be ordered without buying a year's supply
- Versatile - Can be used to package, dispense or store almost any item
- Closure - Reclosable zipper

Item #	Size	Thickness	Qty
7538M	2 x 3"	2 mil	1000
7540M	3 x 4"	2 mil	1000
7543M	3 x 5"	2 mil	1000
7546M	4 X 6"	2 mil	1000
7547M	A 5 x 8"	2 mil	1000
7548M	6 x 9"	2 mil	1000
7555M	8 x 10"	2 mil	1000
7557M	9 X 12"	2 mil	1000

Patient Bags

- Reclosable with a single track zipper
- Pre-printed form with blue ink
- For neat, professional labelling
- 2 mil thick

Item #	Size	Thickness	Qty
7550	B 3 x 4"	2 mil	100
7550M	3 x 4"	2 mil	1000

Clear Bag with Pouch

- Clear zip it bag with self-sealing and inside-fold specimen pouch

Item #	Size	Qty
MGP6X9	C 6 x 9"	1000



Error Prevention Bags

- Safety Step - Serves as a safety step for workers! If medication is in a bag the worker has to read and open to retrieve medication.
- Preprinted Message - Alert users to take precautions when handling contents.
- Closure - Reclosable zipper

Item #	Description	Size	Thickness	Qty
9527	High Alert	4 x 6"	2 mil	100
9534	High Alert	6 x 8"	2 mil	100
9535	High Alert	8 x 11"	2 mil	100
9538	High Alert	3 x 12"	2 mil	100
9537	For Intrathecal Use	6 x 9"	2 mil	100



Poly Bags

Colour-Coded Message Bags

- Colour-coded instruction/safety precaution for easy identification
- Eliminates need for colour-coded or identification labels
- Efficient - Drop it in, zip it up, done! Save time-no labels to apply, no messages to write.
- Closure - Single-track reclosable zipper for details

Item #	Description	Size	Colour	Thickness	Qty
9520	Stat	4 x 6"	● Red	2 mil	100
9521	Refrigerate	4 x 6"	● Blue	2 mil	100
9522	PRN	4 x 6"	● Orange	2 mil	100



AMBER BAGS ARE IDEAL FOR LIGHT-SENSITIVE MEDICATION



Important information?
Document it on these SELF-SEALING
Bags. Tear off the receipt and then
seal them up!



Self-Sealing Bags with Tear-Off Receipt

- Write-On Area - Eliminates the need to handwrite messages or apply labels to the bag.
- Perforated Tear-Off Receipt - For documentation
- Closure - Self-Sealing

Item #	Size	Colour	Thickness	Qty
7514	A 4 x 5.5"	○ Clear	1-1/2 mil	100
7526*	B 6.5 x 7.75"	○ Clear	1-1/2 mil	100
7520*	C 4 x 9.5"	○ Clear	1-1/2 mil	100
7524	6.5 x 10"	○ Clear	1-1/2 mil	100
7518*	D 3.75 x 12.75"	○ Clear	1-1/2 mil	100
17499*	E 10.5 x 2.5"	○ Clear	1-1/2 mil	100
17859	F 3.75 x 6.35"	● Amber	1-1/2 mil	100
17860	6.5 X 10"	● Amber	1-1/2 mil	100
17861*	G 15 x 3"	● Amber	1-1/2 mil	100

*Ideal size for syringes

Self-Sealing Crash Cart Bags

- Self-sealing, tamper evident – simply remove paper strip at top to access adhesive; fold over to seal bag
- Bags can be easily opened by tearing the highlighted perforations - ideal for quick access or code situations
- A tear in the bag indicates prior emergency or tampering
- 2 mil thick
- 20 per package



Poly Bags

Item #	Description	Perforation	Dimensions (W x H)	Colours
1714	Security Bags for Deep Metro® Lifeline™ & Waterloo® CCB	1 center	31 x 21-1/2"	Clear
19840	Amber Security Bags for Deep Metro® Lifeline™ & Waterloo® CCB	1 center	31 x 21-1/2"	Amber
7512	Security Bags for Full-Size CCB	1 center	29 x 20"	Clear
20501	A Amber Security Bags for Full-Size CCB	"H"	29 x 30"	Amber
7505	Security Bags for Full-Size CCB	"H"	29 x 20"	Clear
7515	Security Bags for Full-Size CCB	1 center, 1 end	29 x 20"	Clear
7509	Security Bags for Full-Size CCB w/ Blue Border	1 center, 1 end	29 x 20"	Clear/Blue
7510	Security Bags for Full-Size CCB w/ Red Border	1 center, 1 end	29 x 20"	Clear/Red
7568B	Security Bags for Full-Size CCB Blue or Red	1 center, 1 end	29 x 20"	Blue
7568R	Security Bags for Full-Size CCB Blue or Red	1 center, 1 end	29 x 20"	Red
7506	Amber Security Bags for Full-Size CCB	1 center, 1 end	29 x 20"	Amber
7534	Attn: Pediatrics Only Amber Security Bags for Full-Size CCB	1 center, 1 end	29 x 20"	Amber
7535	Attn: Adult Only Amber Security Bags for Full-Size CCB	1 center, 1 end	29 x 20"	Amber
7517	B Security Bags for Half-Size CCB	1 center	22 x 14"	Clear
7502	Amber Security Bags for Half-Size CCB	1 center, 1 end	22 x 14"	Amber
7500	Security Bags for Blue Bell CCB	1 center	18-1/2 x 15-1/2"	Clear
7503	Security Bags for Top Compartment Metro® Lifeline™ CCB	1 center	21-1/2 x 20"	Clear

Cart Box Item #	Security Bag Item #															
	1714	19840	7512	20501	7505	7515	7509	7510	7568	7506	7534	7535	7517	7502	7500	7503
Shallow CC Box 1870-01, 3215			✓		✓	✓	✓	✓	✓	✓	✓	✓				
Deep CC Box 1875-01, 3219	✓	✓														
Full-Size CC Box 1814 & 1867			✓	✓	✓	✓	✓	✓	✓	✓	✓	✓				
Third-Size CC Box 3150													✓	✓	✓	
Half-Size CC Box 3020, 3013, 3131													✓	✓	✓	
Metro Top Compartment CC Box 3057 & 3211																✓

Hanging Prescription Bags

- Simplify prescription organization and retrieval
- Made of tough, clear 4 mil plastic for extreme durability
- Fits on any rod with a diameter of 1 cm or smaller

Item #	Size (W x H)	Qty
17540 A	10-1/2 x 7-1/2"	10
17541	12 x 9"	10
17542	14 x 12-1/2"	10

Wall Rack for Prescription Bags

- Simple solution to prescription organization
- Saves time, improves accuracy and enhances customer satisfaction
- Aluminum frame is 3 ft. wide and holds five 1 cm thick rods
- Each rod holds approximately 8-10 bags per foot or as many as 150 bags per rack
- Easy assembly, all hardware included
- Measures: 36" W x 57½" H x 7½" D
- Use with hanging bags and ID tags (sold separately)

Item #	Description	Qty
17543	Wall Rack for Prescription Bags	1 frame, 5 rods
17544 B	Green ID Tags	25

Bag Caddy for Hanging Prescription Bags

- Bag caddy designed for use with hanging prescription bags
- Holds up to 40 hanging prescription bags
- Ideal for use in pharmacies, to organize bags to be reused
- Measures: 6"W x 16.5"H x 7"D

Item #
17545 C



Blue Refrigerate Zippit Bag

- Preprinted Message - Alert users to temperature sensitive contents
- Closure - Reclosable zipper

Item #	Size (W x H)	Thickness	Qty
7629-10 D	5 x 8"	2.5 mil	100
18239	3 x 5"	2.5 mil	100

Chemo Waste Bags

- Safe Disposal - Use chemo waste bags to safely and economically dispose of chemo waste
- Closure - Use security seals
- Measures: 23 x 41½" (opens to 31")

Item #	Capacity	Size	Thickness	Qty
18824	12-16 Gallon	25 x 34"	4 mil	50
9617-10 A	20 gallon	23 x 41-1/2"	4 mil	100
20199	20 Gallon	23 x 41-1/2"	4 mil	25
20200	30 Gallon	31 x 41"	4 mil	25



Biohazard Waste Bags

- Stick on biohazard bags (Item # 9938) includes an adhesive strip to provide a secure closure, or use to stick onto cabinets, carts, walls, or other locations
- Small & extra large bags (Item # 7446 and 7445) have double-seam pleated sides that can carry heavy loads

Item #	Description	Size	Thickness	Qty
9938 A	Stick-on bag, 4" fold over flap	12 x 14"	2 mil	100
7446	Small Biohazard Bag	11 1/4 x 14 1/2"	1-1/2 mil	50
7445 B	Extra-large Bag, 33 gallons	20 x 39"	4 mil	25

Chemotherapy Transport & Batch Bags

- Heavy-duty clear reclosable bags provide a secure closure
- "Caution Chemotherapy Drug" yellow labelling

Item #	Size	Thickness	Qty
CT6X9	6 x 9"	4 mil	100
CT6X9M	6 x 9"	4 mil	1000
CT12X15	12 x 15"	4 mil	100
CT12X15M	12 x 15"	4 mil	1000



Chemo Wipe Bags™

- Absorbent - Chemo Bag and Wipe is an absorbent wipe and heavy-duty hazardous waste disposal bag in one. Easily clean chemotherapy and cytotoxic chemical spills and safely dispose of hazardous waste without using large amounts of disposable towels that can spread germs. An adhesive seal ensures total containment and reduces the risk for cross-contamination when used with protective gloves in hospitals and healthcare settings.
- Ambidextrous - Yellow wiping bag has an ambidextrous built-in mitt to provide superior maneuverability and infection control. Just insert gloved hand, wipe up spill, turn inside out and seal! Sealed bag is ready to be disposed of in an approved waste container.
- Capacity - approximately 1 gallon
- Closure - adhesive seal

Item #	Size	Thickness	Qty
20192	11-1/2 x 12"	2 mil	20

Chemobloc™ Safelock Drug Transport Bags

- Provides safe storage and transport of cytotoxic medications
- Reclosable with a single track zipper closure
- Write on area for patient information

Item #	Description	Thickness	Qty
9490	A 6 x 9"	4 mil	100
9491	B 12 x 15"	4 mil	250



Chemotherapy Disposal Bags

- Versatile - Use to transport, store and dispose of items used in chemotherapy prep or administration.
- Closure - Reclosable zipper

Item #	Size	Thickness	Qty
9516	9 x 12"	4 mil	100
9516M	9 x 12"	4 mil	1000
9517	12 x 15"	4 mil	100
9517M	12 x 15"	4 mil	1000

Biohazard Zip It Bags

- Reclosable zip bag with pouch

Item #	Size	Qty
BHZ6X9	A 6 x 9"	1000



Biohazard Specimen Bags

- Easy Access - Bags can be torn open in the tearzone® for safe and easy access. There are no perforations to compromise the integrity of the bag.
- Closure - Reclosable zipper

Item #	Description	Size	Thickness	Qty
9514	B Biohazard Specimen	8 x 10"	2 mil	100
9515	C Biohazard "STAT"	6 x 9"	2 mil	100
9513	D Biohazard Specimen	6 x 9"	2 mil	100

Hazardous Drug Bags

- Closure - Single-track reclosable zipper
- Safe Transport - Clear bags with preprinted warnings keep contents visible during transport and raise awareness for hazardous drug contents. Thickness adds another layer of protection
- Quantity: 100

Item #	Description	Size	Thickness
20414 A	Hazardous Drug Transport Bags	4 x 6"	4 mil
20415	Hazardous Drug Transport Bags	12 x 15"	4 mil
18488 B	Caution Hazardous Drug (RCRA) Bags	4 x 6"	2 mil
20868	Caution Hazardous Drug (RCRA) Bags, Black	6 x 9"	2 mil



Insulin Pen Bag, 8 x 2

- Pre-Printed Message: Bag reads "Insulin Pen" and provides space to write the patient's name.
- Insulin Pen Storage: Patient-specific insulin pens can be easily identified and safely stored in this preprinted reclosable bag.
- Thickness: 2-mil
- Closure: Single-track reclosable zipper
- Quantity: 100 per pack
- Dimensions: 8"W x 2"H

Item #
18503 C

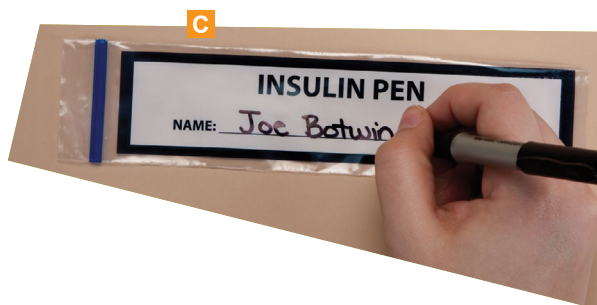

Leakproof Chemo Bags

- 18487, 18220 Caution Hazardous Drug Bags
- 20289, 20290 hazardous Drug Leakproof Bags
- Prevent Leakage: Patented liquid-tight closure prevents leaks and the risk for contamination
- Seal & Reveal: Press and Close system seals bag; ES open TearZone replaces hard-to-open scores and perforations that can leak
- Document Ready: Disposable bags include a pocket for important paperwork

Item #	Description	Size	Thickness	Qty
18487 D	Caution Hazardous Drug Bags	4 x 6"	2 mil	100
18220	Caution Hazardous Drug Bags	9 x 12"	2 mil	100
20289 E	Hazardous Drug Leakproof Bags	6 x 9"	2 mil	100
20290	Hazardous Drug Leakproof Bags	12 x 15"	2 mil	100



A



B



C



D

Tamper Evident Bags

- Thickness: 2¾ mil
- Special Features:
 - Dual serial numbers and a tear-off receipt provide traceability
 - Permanent pressure-sensitive adhesive. Flap reads 'Void' if opened after sealed.

Item #	Description	W x H	Colour	Qty
11310	A Personal Property Bags	8 x 10"	Clear	25/pkg
11311	Personal Property Bags	8 x 10"	Clear	250/roll
11312	Personal Property Bags	9 x 12"	Clear	25/pkg
11313	Personal Property Bags	9 x 12"	Clear	250/roll
11308	B Evidence/Chain of Custody Bags	9 x 12"	Clear	25/pkg
11309	Evidence/Chain of Custody Bags	9 x 12"	Clear	250/roll
10456	Patient's Medicine Inventory Bags	6 x 9"	Clear	25/pkg
10446	Patient's Medicine Inventory Bags	6 x 9"	Clear	250/roll
10457	Patient's Medicine Inventory Bags	9 x 12"	Clear	25/pkg
10447	Patient's Medicine Inventory Bags	9 x 12"	Clear	250/roll
19749	Patient's Medicine Inventory Bags	12 x 14"	White	25/pkg
19749-31	Patient's Medicine Inventory Bags	12 x 14"	White	250/roll
19750	Patient's Medicine Inventory Bags	12 x 14"	Clear	25/pkg
19750-31	Patient's Medicine Inventory Bags	12 x 14"	Clear	250/roll
10458	Patient's Medicine Inventory Bags	9 x 12"	White	25/pkg
10448	C Patient's Medicine Inventory Bags	9 x 12"	White	250/roll
20231	D Patient Valuables Bags	9 x 12"	Grey/White	100/pkg
10472	Alert Void Security Bags	8 x 10"	Clear	25/pkg
10440	Alert Void Security Bags	8 x 10"	Clear	250/roll
10473	Alert Void Security Bags	8 x 10"	White	25/pkg
10441	Alert Void Security Bags	8 x 10"	White	250/roll
10475	Alert Void Security Bags	9 x 12"	White	25/pkg
10443	Alert Void Security Bags	9 x 12"	White	250/roll
10474	Alert Void Security Bags	9 x 12"	Clear	25/pkg
10442	Alert Void Security Bags	9 x 12"	Clear	250/roll
10477	Alert Void Security Bags	10 x 14"	White	25/pkg
10445	Alert Void Security Bags	10 x 14"	White	250/roll
10476	Alert Void Security Bags	10 x 14"	Clear	25/pkg
10444	Alert Void Security Bags	10 x 14"	Clear	250/roll
10478	Standard Security Bags	8 x 10"	White	25/pkg
10479	Standard Security Bags	8 x 10"	White	500/roll

KwikDose™ Oral Dispensers

- Self-righting caps included (will not fit luer needle)
- Safe for neonatal, pediatric and adult use
- Unique tip design prevents wrong-route administration
- Chemically inert to provide stability for drug storage and transport
- Enlarged numbers for quick and accurate volume identification
- Includes distinct bilingual labeling “For Oral Use Only”

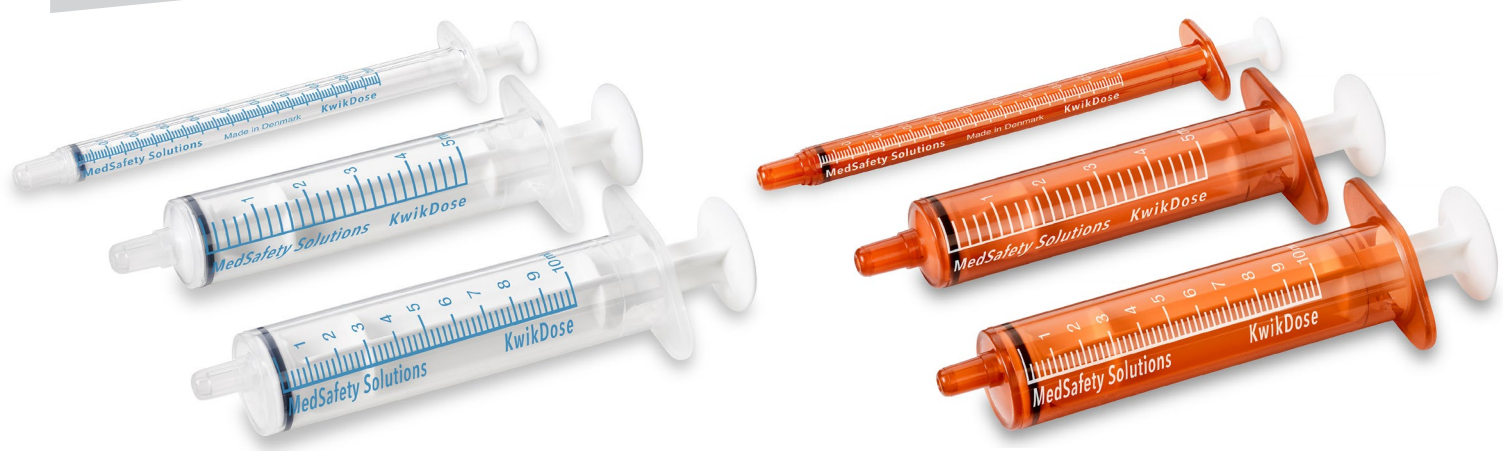

Clear Oral Dispensers

Item #	Capacity	Increments	Colour	Qty
010200	0.5 mL	0.01 mL	Clear	100
0200	0.5 mL	0.01 mL	Clear	500
010201	1 mL	0.01 mL	Clear	100
0201	1 mL	0.01 mL	Clear	500
010203	3 mL	0.01 mL	Clear	100
0203	3 mL	0.01 mL	Clear	500
010205	5 mL	0.2 mL	Clear	100
0205	5 mL	0.2 mL	Clear	500
010210	10 mL	0.2 mL	Clear	100
0210	10 mL	0.2 mL	Clear	500
010220	20 mL	1 mL	Clear	100
01221	60 mL	1 mL	Clear	75

Amber Oral Dispensers

Item #	Capacity	Increments	Colour	Qty
011200	0.5 mL	0.01 mL	Amber	100
01200	0.5 mL	0.01 mL	Amber	500
011201	1 mL	0.01 mL	Amber	100
01201	1 mL	0.01 mL	Amber	500
011203	3 mL	0.01 mL	Amber	100
01203	3 mL	0.01 mL	Amber	500
011205	5 mL	0.2 mL	Amber	100
01205	5 mL	0.2 mL	Amber	500
011210	10 mL	0.2 mL	Amber	100
01210	10 mL	0.2 mL	Amber	500
011220	20 mL	1 mL	Amber	100
01222	60 mL	1 mL	Amber	25

Tip Caps, Self-Righting

- Fits all KwikDose™ oral dispensers
- Made out of high-density polyethylene
- Latex-free



Item #	Qty
50300	100

Oral Dispensing Syringe w / Tip Cap

- Clear graduation markings for accurate medication delivery
- Not made with natural rubber latex
- Special tip design will not accept Luer connectors, preventing medication errors and the accidental intravenous injections of oral liquids
- Includes protective tip cap for transportation with no spillage
- User-friendly gradation in millimeters

Item #	Capacity	Increments	Qty	Colour
S10205	5 ml	1 ml	100	Clear
S205	5 ml	1 ml	500	Clear
S10210	10 ml	1 ml	100	Clear
S210	10 ml	1 ml	500	Clear
S11210	10 ml	1 ml	100	Amber
S1210	10 ml	1 ml	500	Amber



Tamper Evident Syringe Seals with Pre-Printed Messages

- Pre-printed with “Do Not Use if Seal Is Broken” in red
- Cannot be re-attached once removed
- Packaged in a dispensing box
- See more tamper evident solutions on pages 61



Item #	Colour	Size	Length	Qty
7997	A Silver	Short	35/8"	1000
7998	B Silver	Long	41/4"	1000
8001	C White	Short	31/2"	1000

Press-In Bottle Adapters

- Converts a standard bottle into a dispensing device
- Plastic adaptors fit into bottle openings and allow syringes to be easily inserted and filled without a mess
- Bottle caps can still be secured with the adaptor in place
- Non-sterile

Item #		For Bottle Neck	Qty
17282	A	20 mm	20
17282-10		20 mm	100
17283	B	24 mm	20
17283-10		24 mm	100
17284		28 mm	20
17284-10		28 mm	100
17285		33 mm	20
17285-10		33 mm	100
19392		22 mm	50
19393		24 mm	50
19394		28 mm	50



SealSafe™ Self-Sealing Pierced Bottle Adapters

- Prevent Contamination - Reseal quickly to provide a safe, clean and consistent seal. Helps prevent evaporation, spills and contamination
- Easy Conversion - Non-sterile adapters quickly and easily convert standard prescription bottles into filling devices Compatible with most brands of oral dispensers
- Pierced Closure - Recommended for use with liquids slightly below, at or above the consistency of water
- Material - Thermoplastic elastomer and a proprietary blend of polypropylene

Item #		For Bottle Neck	Qty
20227	C	20 mm	20
20227-31		20 mm	200
20228		20 mm	20
20228-31		20 mm	200
20229		24 mm	20
20229-31		24 mm	200
20230		28 mm	20
20230-31		28 mm	200



StaySafe™ Self-Sealing Bottle Closure

- Converts a standard bottle into a dispensing device
- Self-sealing closure maximizes safety and accuracy when dosing liquid medications
- Helps prevent evaporation, spills and contamination
- Closure is easily penetrated by oral dispenser and reseals when syringe is removed
- Prevents waste - allows access to the last drop
- Bottle caps and standard child resistant caps can still be secured with the adaptor in place
- Non-sterile

Item #		For Bottle Neck	Qty
17727	D	24 mm	20
18761		28 mm	20

Tamper Evident Oral Tip Caps

- Three-part plastic cap for oral dispensers
- Secure, non-sterile cap requires user to break off outer sleeve in order to dispense medication
- Tamper-indicating red ring remains in place, indicating outer sleeve has been removed
- Cap is made of polypropylene, sleeve of polystyrene plastic
- Latex free

Item #	Dispenser Compatibility	Qty
52300	KwikDose™	100



- Tamper evident syringe cap improves medication security by clearly showing that the syringe is intact
- Red luer lock cap for standard luer lock syringes
- Made out of polypropylene
- Sterile
- Convenient - unique blister pack of 10 protects the sterility of unopened caps

Item #	Qty
65001	100/case, packaged individually

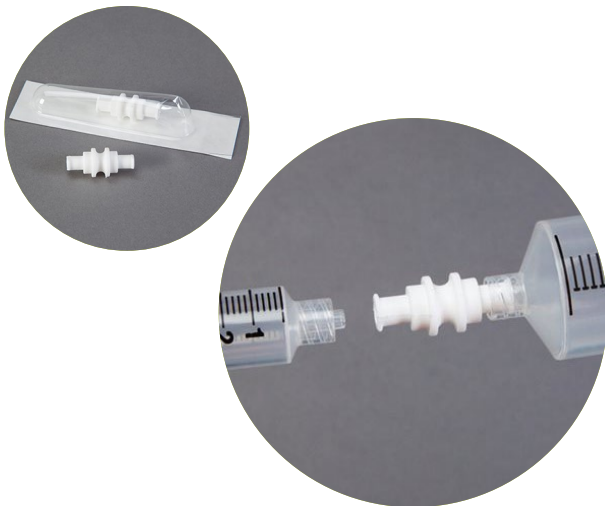

Tamper-Evident Luer Lock Tip Caps

- Three-part plastic cap used to indicate tampering on a luer lock syringe
- Sterile and non-pyrogenic in unopened, undamaged package
- Latex free
- Packaged in trays of 10

Item #	Qty	Colour
64010	100	Red
17360B	100	Blue

Luer Lock Tip Caps

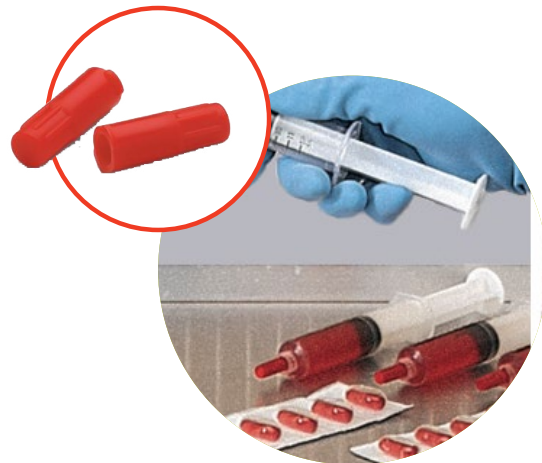

Sterile Female-Female Luer Lock Connector

- Easy Fill Solution - Sterile-packaged, Female-Female Luer Lock Connector connects to male luer, syringe, tube sets, repeating syringes, IV bag ports, etc., to create the perfect solution to fill dispensers from a luer connection.
- Sterile - Individual blister packaging protects the sterility of unopened connectors.

Item #	Qty
19158	100/case

Guarded Syringe Connector

- Female to female syringe connector
- Estimated 0.07 mL of fluid loss during transfer
- High quality adapter
- Individually packaged

Item #	Qty
52400	50



Medication Delivery



Sterile Male-Male Luer Slip Adapter

- Packaged Sterile
- Pyrogen Free
- Individual Blister Packs

Item #	Qty
19156	50

Sterile Luer-Lock Syringe Caps

- Improve Productivity - Ideal for volume capping of syringes during compounding. Sterile packaging tray provides immediate access to 10 sterile caps and allows users to open 2 caps at a time without compromising the remaining caps.
- Compatibility - Fits all mL syringes.
- Color Options - Red & White. Specify colour when ordering.

Item #	Qty
19159	100/case



Dissolve-A-Dose, 15 mL

- Dissolve cut tablets or powder quicker and easier than the powder paper technique
- Adaptable cap allows medication to be drawn up into oral syringe for immediate administration or to add diluents

Item #	Size	Qty
5294	15 mL	50

DoseLine Labels

- Clear sticker with black keyline
- Designed for use on oral liquid dispensers, or other graduated containers
- Made of clear poly film, latex free
- Labels measure 1-9/16" x 3/8" (40 x 9.5 mm)
- Conveniently packaged in rolls of 500, 2 rolls per box
- Packaged in a convenient dispensing blister, compatible for use with PharmaSystems' label dispensers

Item #	Size
42910	A 2 x 1/2"

Locking Tip Cap

- Self-threading, securely locks onto a cathay syringe or catheter tip adapter
- Made of ABS plastic, latex free
- Sterile and non-pyrogenic when unopened
- 25 per package

Item #
67031

Adapter Caps

- Easy to Use - Converts a standard medication bottle into a filling device for plastic oral dispensers.
- Let Us Help - To match the right adapter cap to a bottle, print the Adapter Cap Sizing Template here (print at 100% for the most accurate sizing).
- Material - Low-density polyethylene

Item #	Size	Qty
8010-10	C 18 mm/A	20
8012-10	20 mm/B	20
7884-10	22 mm/C	20
7886-10	24 mm/D	20
8019-10	24 mm/M	
7883-10	28 mm/E	20
8013-10	28 mm/F	20
8018-10	28 mm/K	20
8014-10	33 mm/G	20
19541	38 mm/I	20

[Download intructions and sizing template here](#)



Sterile Rapid Fill Connectors

- Luer lock-to-oral slip connection
- Connects to male luer or syringes, tube sets, repeating syringes, bag ports, etc.
- Flange facilitates contamination-free handling
- Made out of natural polypropylene
- 50 per package, packaged individually

Item #	Description	Colour
12703	Luer Lock-to-Oral Slip	○ Natural
13701 A	Luer Lock-to-Luer Slip	● Blue
13901	Luer-Lock-to-Luer Lock	● Red
13915	Luer Lock-to-Luer Lock with Cap	● Red

Luer Lock-to-Oral Slip Connector

- Connect oral dispensers to luer filling devices such as syringes, from a pharmacy pump tube set, repeating syringe, or a large source
- Made out of clear polypropylene, latex-free
- Non-sterile
- 50 per package, packaged individually

Item #
12701 B

Sterile Luer Lock Universal Spike

- Sterile spike with a female luer lock connector
- Ideal for additions and withdrawals from IV bags or bottles
- Spike is made of ABS; vent is made out of hydrophobic filter, and sheath is made out of polyethylene, latex-free
- Sterile and non-pyrogenic in unopened package
- 20 per package

Item #
29 C

Luer Lock-to-Catheter Tip Adapter

- Sterile, polypropylene adapters with a female luer lock connector on one end and a male catheter tip on the other end
- Ideal to adapt luer lock connections for catheter and urethra tips
- Safely transport cytotoxic drugs in a securely capped standard luer lock syringe, then convert the syringe to a catheter tip for administration
- Sterile and non-pyrogenic in unopened package
- Latex-free

Item #	Qty
13601 D	50

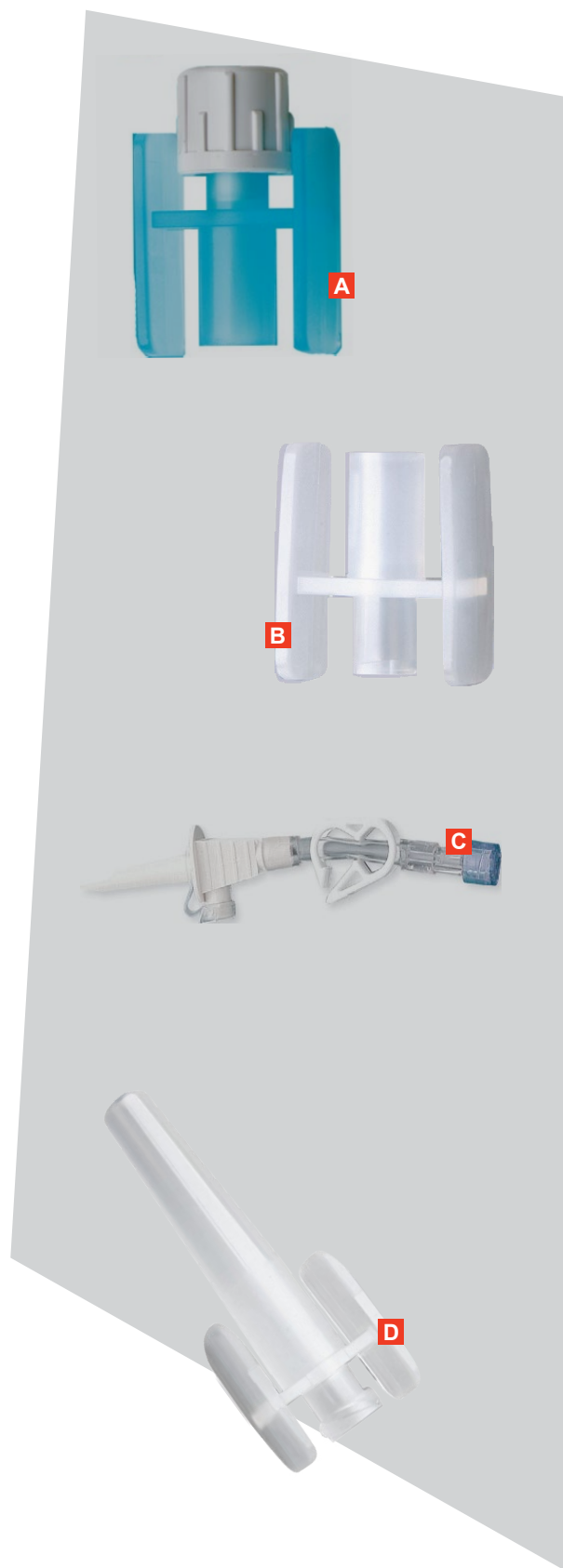

Sol-M® Luer Lock Syringes

- Low Dead Space (LDS) syringes minimize “dead space”, which is the area within the syringe that retains medication even after it has been injected. Minimizing this “dead space” improves the efficiency of medication delivery by reducing the amount of medication wasted with every administration
- LDS Syringes increase the number of doses from each vial
- High-transparency barrel to easily visualize contents
- Silicone lubrication ensures smooth plunger movement
- Luer lock syringe available in a wide range of sizes and connection combinations
- Safe plunger backstop prevents accidental withdrawal of plunger
- Individually packaged

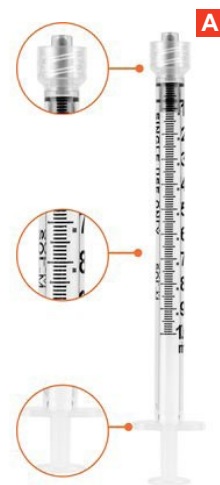

Item #	Description	Qty
V0201	A Sol-M® 1ml Low Dead Space Luer Lock Syringe (without needle)	100
V0203	3ml Luer Lock Syringe (without needle)	100

Sol-Care® Safety Needle



- Sol-Care™ Safety Needle is a single use, standard hypodermic needle with a protective arm that is used to enclose the needle after use to protect the healthcare professionals from needlestick injury
- In the activated position, the protective arm guards against accidental needle stick during normal handling and disposal of the used needle/syringe combination
- Two options for protective arm activation: hard surface activation and thumb activation
- Simple one-handed safety shield mechanism
- Individually packaged

Item #	Description	Qty
V0205	B Adult Needle 1" (Adult)	100
V0206	Safety Needle 1-1/2" (For Higher BMI Population)	100
V0207	Safety Needle 5/8" (Adolescents/Infant)	100

Venting Needle, 20 gauge

- Sterile filtered venting needle designed for use by pharmacists and other specialists to evacuate drug containers during medication preparation and delivery
- Can be used with any vial or bottle
- 0.2 micron hydrophobic filter yellow transfer needle is compact and easy-to-handle
- 20 gauge x 1-1/2" stainless steel non-coring needle easily penetrates all stoppers with minimum risk of damage



Item #	Qty
18955	C 25

Learn more about our needles & syringes specifically made for veterinary clinics here!

Looking for medical aesthetic needles? View our assortment here!



16G Two-Fer Needles, Sterile

- Thin-walled stainless steel needle glued into a vented luer-lock hub using UV-cured adhesive
- Functions as both a high-efficiency, non-curing needle and as an easy-to-use venting device
- Hubs are colour coded for identification
- Dual purpose needle - transfer liquids into closed vials without over pressurization of vial, transfers high-volume liquids using pumps and repeating syringes and withdraws solution from vials without creating negative pressure

Item #	Length	Qty	Colour
19003	D 1"	100/pack	Green
16004	E 1/2"	100/pack	Purple

Aspirating Needle

- The sharp cannula is used to draw fluid for reconstruction or to pre-fill syringes prior to administration.
- Packaged Sterile
- Pyrogen Free
- Individual Blister Packs

Item #	Description	Qty
17046	19 guage x 3"	100
17047	19 guage x 5"	100
17056	16 guage x 3.5"	100



Spiked Plastic Fill Needle

- Pointed tip penetrates rubber stoppers for easy filling - attaches to a luer tip
- Vented to allow air to escape while filling
- Disposable
- Sterile

Item #	Qty
7723	100

Tamper Resistant Add-Port Cap

- Restricts access to the additive port on bags
- Positive lock seals once and cannot be reopened
- Non-sterile
- Body: Polypropylene

Item #	Qty	Colour
4858	100	Red
4073	25	Blue

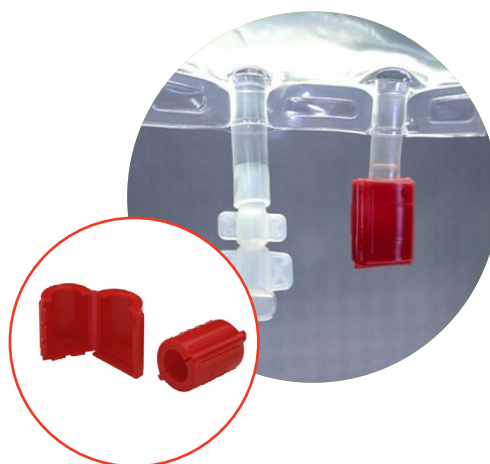

Chemo-Vent® Filtered Venting Needle

- Filtered venting needle designed for use when reconstituting and withdrawing cytotoxic anti-neoplastic agents
- The non-coring needle easily penetrates all stoppers with minimum risk of damage, while the hydrophobic filter maintains asepsis and prevents toxic, aerosolized materials from leaving the container during filling
- Red color coding to safely identify use with cytotoxic agents
- 0.2 micron hydrophobic filter
- 20 gauge x 1.5" non-coring, stainless steel needle (non-reactive to agents such as cis-platin)

Item #	Qty
18723	25
18723-10	100

PharmAssure® Hydrophilic Syringe Filters

- Superior flow rate and longer life
- Supor® polyethersulfone membrane has proven drug compatibility
- Low priming volume (minimum retention volume 50 microlitre)
- Double Luer connector for added safety
- Endotoxin reduction in compounding applications
- Latex free, non-pyrogenic, sterile, single use
- Maximum operating pressure (75 psi)
- Chemically and biologically inert
- Color coded housing to differentiate pore size

Item #	Description	Qty
21006	25mm, 0.2µ	50



Ampule Crackers

- Non-breakable plastic fracture and safety collar, specifically designed to aid in the opening of pre-scored glass ampules
- Simply slip over the top of the pre-scored portion of the ampule, snap it, and discard both the ampule top and safety collar to prevent cross contamination
- Disposable - eliminates need for sterilization

Item #	Size	Qty
7372	1-4 mL Ampules	100
7374	5-10 mL Ampules	100



Ampule Opener

- Small cutting blade inside scores the ampule stem to help ensure a clean break
- Will work with most sizes of ampules
- Reduces the chance of finger cuts and injuries
- Reusable, can be sterilized
- Measures 2½" L x ¾" D

Item #	Qty
7371	1

Disposable Ampule Breaker

- Ampules can be safely opened by snapping the top of the ampule breaker to the side; thus breaking the top of the ampule off at the neck of the bottle - top of the ampule can then be discarded along with the ampule breaker
- Reduces the chance of finger cuts and cross contamination
- Disposable - eliminates need for sterilization
- Made out of polypropylene plastic
- Measures 2 x 1¼"

Item #	Qty
10262	100

Fluid Transfer Tube Set with Vented Spike

- Vented inlet spike and luer lock outlet for filling sterile oral dispensers, luer syringes, vials, elastomeric infusers, minibags and cassettes from IV bags or bottles of solution
- Use in conjunction with rapidfill connectors, dispensing pins or 16 gauge TwoFer Needles
- Tubing made of PVC; connectors made of ABS and clamp made of homopolymer



Item #	Qty
11	10



Fluid Transfer Tube Set

- Male luer lock connections allow needle, luer lock spike or dispensing pin to be used at the inlet and outlet
- Tubing made of PVC, connectors made of ABS and clamp made of homopolymer
- Individually packaged, 10 per case

Item #	Pack Qty	Case Qty
21	1	10

Kwik-Vial™

- Amber, light-resistant plastic vials with durable heat-sealed foil lids, ideal for unit dose packaging, delivery and administration of oral liquid medications
- Factory sealed, foil laminate with peel-back top (non-sterile)
- Plastic tray keeps vials clean, separated and in ideal fill position
- Latex-free, made of high-density polyethylene; sealing plug is made out of polypropylene; laminated foil lid is 3.9 mil thick
- Labels are not included. Compatible labels are item #20475

Item #	Size	Qty
30015	15 mL	300 (50/tray)
30030	30 mL	300 (50/tray)



Kwik-Vial™ Plug Dispenser

- Allows for rapid, clean placement of Kwik-Vial™ Plug
- Dispenser holds enough plugs to fill a complete tray of 50 vials

Item #

30009



Kwik-Vial™ Filling Extension

- Attaches to any male luer fitting to facilitate vial filling
- Extends into filling hole of Kwik-Vial™ to help guide fluid path
- Made out of polyvinyl chloride; latex-free
- Non-sterile

Item # Qty

30008 50

Repeater Pump

- Designed to transfer fluids at volumes from 0.2 ml to 9.999 ml at flow rates up to 13.5 ml per second with a 16-gauge needle
- Drawback feature to relieve line pressure and prevent fluid drippage between fills
- Interval mode to avoid pressing start/stop repeatedly
- Powerful motor with 27 speed combinations (including reverse mode), enabling it to pump viscous fluids and fill elastomeric infusors
- 20-cell memory storage for commonly used pump settings to standardise repeated applications

Item # Description

99 Repeater Pump

30 Repeater Pump Stand

32 Repeater Pump Bag Pole

99-PED Repeater Pump Foot Pedal



ENFit® Syringes

- **Prevent Misconnections:** ENFit® tip requires a twisting motion to connect. This new design only fits enteral devices to help prevent misconnections.
- **Easy to read:** Syringes feature 1 ml graduated markings to help improve dosing accuracy.
- **Packaging:** Syringes include tip caps. 60 ml syringes are packaged in a reclosable IV pole bag.



Clear ENFit Syringes

Item #	Description.	Size.	Qty
19798-31	Low Dose ENFit Syringe	1 ml	50
19798-500	Low Dose ENFit Syringe	1 ml	500
19799-31	Low Dose ENFit Syringe	3 ml	50
19799-500	Low Dose ENFit Syringe	3 ml	500
19801-31	ENFit Syringe	10 ml	50
19801-500	ENFit Syringe	10 ml	500

Amber ENFit Syringes

Item #	Description.	Size.	Qty
20306-50	Low Dose ENFit Syringe	1 ml	50
20306-500	Low Dose ENFit Syringe	1 ml	500
20307-50	Low Dose ENFit Syringe	3 ml	50
20307-500	Low Dose ENFit Syringe	3 ml	500
20308-50	ENFit Syringe	5 ml	50
20308-500	ENFit Syringe	5 ml	500
20309-50	ENFit Syringe	10 ml	50
20309-500	ENFit Syringe	10 ml	500
20310-50	ENFit Syringe	20 ml	50
20310-500	ENFit Syringe	20 ml	200
20311	ENFit Syringe	3 ml	50
20311-500	ENFit Syringe	35 ml	500
20318	ENFit Syringe	60 ml	50
20318-500	ENFit Syringe	60 ml	500

Tamper Evident ENFit Tip Caps

Item #	Description.	Qty
19960	Tamper Evident Tip Caps for ENFit Syringes	100
19960-10	Tamper Evident Tip Caps for ENFit Syringes	1000

Includes Tip Caps

ENFit® Bottle Adapter with Connector

- Improve Patient Safety - Prevent accidental misconnections by using items compatible with ISO standard 80369-3.
- Easy to Use - Accessories make it easy to draw medication from bottles or med cups. Adapters are non-sterile.
- Versatile - Adapters with male ENFit connection are available in five sizes to accommodate a variety of bottle neck sizes. Bottle caps can be used with adapters in place.

Item #	Size	Qty
20312-10	A 12-15 ml	100
20313-10	14-16.5 ml	100
20314-10	17-20.5 ml	100
20315-10	19-23 ml	100
20316-10	24-26 ml	100



ENFit® Milk Bottle Transfer Lid

- Enables clean and accurate extraction of milk from a bottle, using an ENFit syringe
- Tethered cap for safe storage
- Can be used in conjunction with Tamper Evident labels for additional security
- A closed system to efficiently draw out the contents of the bottle using an ENFit syringe
- Air circulation feature, to avoid leakage of precious contents

Item #	Qty
10180	B 50



ENFit® Oral Stepped Bottle Adaptor

- Versatile: Offers a solution for both oral and ENFit syringes
- Size: Stepped adaptor fits bottle opening 16-28 mm

Item #	Qty
21052	C 50



Rx Crush™ ENFit® Pouches, Threaded

- Avoid Clogged Tubes - Designed for use with the 19846 RxCrush ENFit Tablet Crusher and works with any ENFit syringe. Threaded attachment provides a secure syringe grip. Zip closure keeps crushed medicine contained. Dissolved medication is easily delivered through ENFit feeding tubes.
- Reduce Waste - Residual medication waste is reduced by crushing and dissolving med in the pouch. No med cups or medication straws needed.
- Easy to Use - Place tablet inside ENFit pouch. Attach syringe (sold separately) to pouch before crushing. Place pouch under platform and press down on tablet to crack it before crushing. With pouch under the large roller, rotate roller to achieve desired consistency.

Item #	Size	Qty
20322	D 3"W x 5¼"H	50



What label should I use with my blister?

When choosing a blister & label combination, it is critical that the proper components are aligned with respect to class to provide the stated level of protection.

Determine Required Packaging It is critical that proper components are used to provide the stated level of protection. When used properly, blisters and labels conform to USP Package Class Ratings (USP 27 section <671>). Click to view additional details: class rating , sizing , label compatibility , and more.				Compatible Labels Select from paper-topped foil labels (no adhesive application required), flag labels or thermal labels.			Select Packaging System Click to View Online, + Roller for sealing labels (Item # 7089) & Patented EZ Grid® Applicator Frame (Item # 6520)	
Size	Blister Type	Blister	Color	Laser Labels	Laser Flag	Thermal	System	Tray Laser/Thermal
Small	Class A Round Blister 3/16"	6500	Amber, Green	Class A or B 6504		Class A or B 6506W	EZ Grid®	6521 / 6524
	Class A Small Aclar®	7016	Amber	Class A 6121	Class A 6025	Class A 17297, Class A 18500	Classic	6472 (Foam) 21126 (Rigid)
	Class A Small PVdC	7074	Amber	Class A 6121	Class A 6025	Class A 17297, Class A 18500	Classic	6472 (Foam) 21126 (Rigid)
Medium	Class A Round Blister 3/8"	6501	Amber, Green	Class A or B 6504	-	Class A or B 6506W	EZ Grid®	6521 / 6524
	Class A Slot Blister 3/8	6507	Amber, Green	Class A 6509	-	-	EZ Grid®	6522
	Class A Medium Aclar®	7014	Amber	Class A 6121	Class A 6025	Class A 17297, Class A 18500	Classic	6472 (Foam) 21126 (Rigid)
	Class A Medium PVdC	7075	Amber	Class A 6121	Class A 6025	Class A 17297, Class A 18500	Classic	6472 (Foam) 21126 (Rigid)
	Class A Round Blister 11/16"	6502	Amber, Green	Class A or B 6504	-	Class A or B 6506W	EZ Grid®	6521 / 6524
	Class A Slot Blister 5/8"	6508	Amber, Green	Class A 6509	-	-	EZ Grid®	6522
Large	Class A Large Aclar®	7015	Amber	Class A 6121	Class A 6025	Class A 17297, Class A 18500	Classic	6472 (Foam) 21126 (Rigid)
	Class A Large PVdC	7076	Amber	Class A 6121	Class A 6025	Class A 17297, Class A 18500	Classic	6472 (Foam) 21126 (Rigid)
Shallow Round	Class A Round 3/8" Depth PVdC	7021	Amber	Class A 6125	-	-	Classic	6461 (Foam) 21125 (Rigid)
	Class A Round 3/8" Depth PVdC	7022	Green	Class A 6125	-	-	Classic	6461 (Foam) 21125 (Rigid)
	Class A Round 3/8" Depth PVdC	7023	Blue	Class A 6125	-	-	Classic	6461 (Foam) 21125 (Rigid)
Deep Round	Class A Round 1" Depth PVdC	7024	Amber	Class A 6125	-	-	Classic	6464 (Foam) 21125 (Rigid)
	Class A Round 1" Depth PVdC	7025	Green	Class A 6125	-	-	Classic	6464 (Foam) 21125 (Rigid)
	Class A Round 1" Depth PVdC	7026	Blue	Class A 6125	-	-	Classic	6464 (Foam) 21125 (Rigid)
Condensed	Class A Condensed Aclar®	7019	Amber	Class A or B 6123	-	-	Classic	6462 (Foam) 21118 (Rigid)
	Class A Condensed PVdC	7079	Amber	Class A or B 6123	-	-	Classic	6462 (Foam) 21118 (Rigid)
Micro Medium	Class A Micro Aclar®	7017	Amber	Class A 6027	-	-	Classic	6468 (Foam) 21119 (Rigid)
	Class A Blister Block Aclar®	7004	Amber	Class A 6126	-	-	Classic	6460 (Foam) 21117 (Rigid)
Small	Class B Small PVC	7013	Amber	Class B 6118	-	Class B 17295	Classic	6470 (Foam) 21121 (Rigid)
Medium	Class B Medium PVC	7012	Amber	Class B 6118	-	Class B 17295	Classic	6470 (Foam) 21121 (Rigid)
Large	Class B Square Blister 5/8"	6512G	Green	Class B 6514W	-	-	EZ Grid®	6523
	Class B Large PVC	7011	Amber	Class B 6118	-	Class B 17295	Classic	6470 (Foam) 21121 (Rigid)
Extra Large	Class B Square Blister 11/4"	6513G	Green	Class B 6514W	-	-	EZ Grid®	6523
	Class B Round Blister 1"	6503	Amber, Green	Class A or B 6504	-	Class A or B 6506W	EZ Grid®	6521 / 6524
	Class B XLarge PVC	7010	Amber	Class B 6122	-	-	Classic	6469 (Foam) 21120 (Rigid)
Condensed	Class B Condensed PVC	7007	Amber	Class A or B 6123	-	-	Classic	6462 (Foam) 21118 (Rigid)
Keyhole	Class B Keyhole PVC	7006	Amber	Class B 6118	-	Class B 17295	Classic	6473 (Foam) 21122 (Rigid)

Maximize Efficiency using our free online label printing solution here!
 Click to view hundreds of templates & customizable label layouts

Unit Dose Solutions

- PharmaSystems® is proud to offer a large selection of unit-dose packaging solutions – blisters and lidding to meet your custom site-specific packaging decision criteria. This system is fast, efficient and economical for small volume packaging – requires less downtime, and no chance of mechanical failure!
- Ideal for small packaging runs, allergy risk medications, high-risk medications, chemo drugs and solid unit dose packaging



Class A Labels for Blisters

- Proper Use:** Use with Class A Blisters to meet USP Class A package requirements
- Neat Application:** Foil Labels are paper-topped. No adhesive is applied over the medication cavity or lift open tabs
- Colour Options:** 6121 Laser Labels are available in Blue, Green, Red, White and Yellow. Specify colour when ordering
- Smart Design:** Can't fit everything on your label? Flag it! Our 6025 Flag labels have an adhesive-backed print area for typical drug label information and a flag area for additional drug or patient-specific information

Packaged:

6121: 32 labels per sheet; 100 sheets per box; 3,200 labels total

6025: 16 labels per sheet; 100 sheets per box; 1,600 labels total

17297: 1,600 per roll

18500: 1,280 per roll

6126: 32 labels per sheet; 100 sheets per box; 3,200 labels total

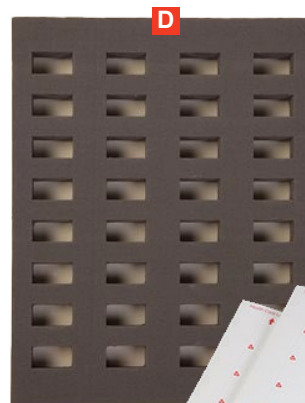

Item #	Description	Dimensions W x H	Setup
6121*	A Class A Laser Labels for Class A S, M & L Blisters	11-1/16 x 13/16"	4 across and 8 down
6025*	B Class A Laser Flag Labels for Class A S, M & L Blisters	3-3/4 x 13/16"	2 across and 8 down
18500	C Class A Thermal Transfer Strip Labels for Class A S, M & L Blisters	1-1/8 x 1-5/8"	1 across
6472	D Foam Sealing Tray for Class A S, M & L Blisters	8-1/2 x 11"	4 across and 8 down
6126*	E Class A Laser Labels for Blister Blocks	11-1/16 x 1-3/16"	4 across and 8 down
6460	Foam Sealing Tray for Blister Blocks	7 x 10"	-

*Laser labels should be stored at 70° - 80°F and 50% relative humidity (±5%) away from heat sources and not exposed to direct sunlight. Labels should be stored in the room in which they will be printed at least 48 hours prior to printing. Not for use with thermal printers.



Class A Aclar & PVdC Amber Blis- ters

- **Proper Use:** Blister/label combo meets the USP Class A package requirements
- **Packaged:** 16 blisters per strip; 100 strips per package; 16,00 blisters total

Blister Blocks

- **Efficient Design:** This medium-cavity, 16-b blister block allows an entire grid of labels (6126) to be applied simultaneously
- **Packaged:** 16 blisters per sheet; 100 sheets per package; 1,600 blisters total

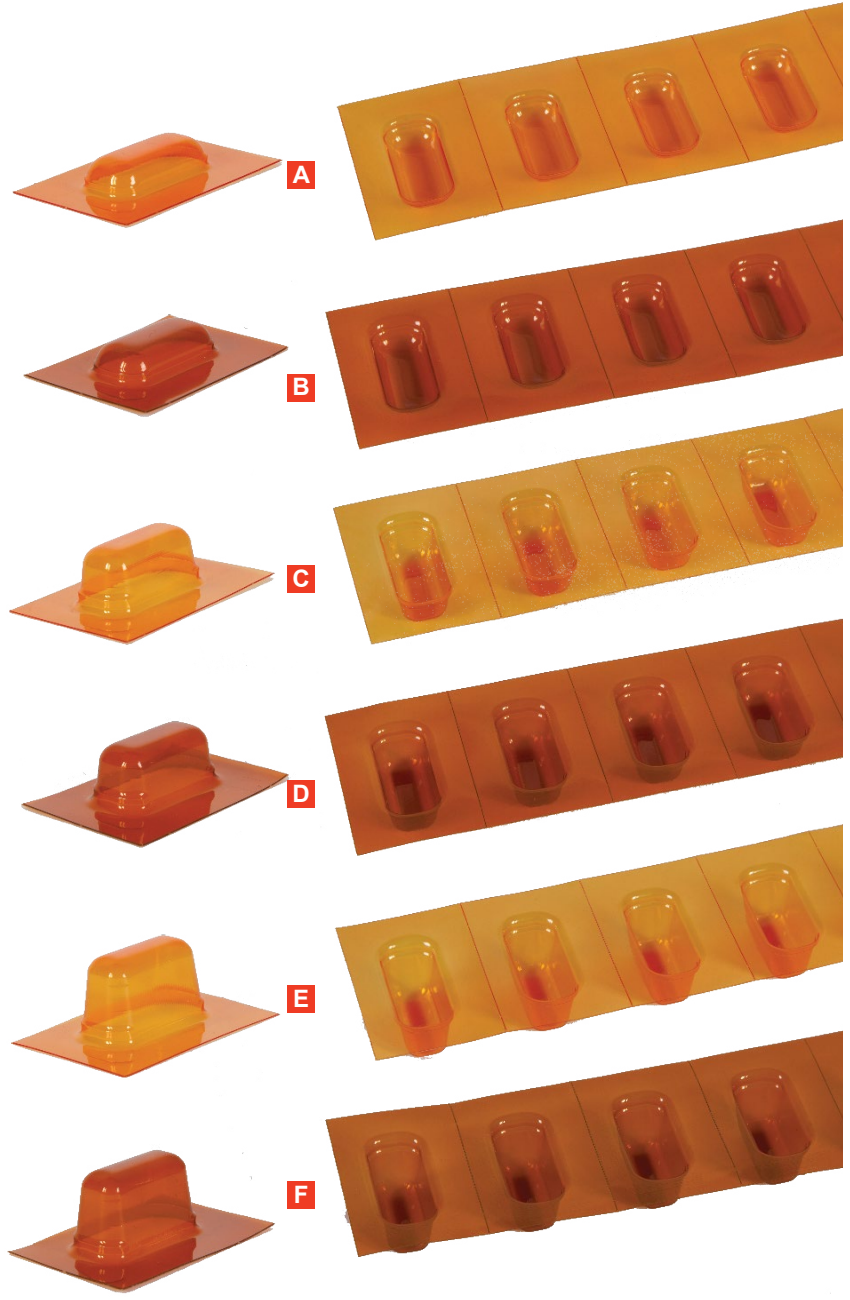

Unit Dose Solutions

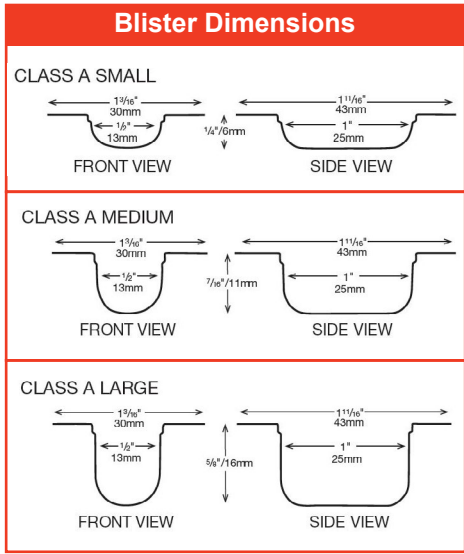

Item #	Description	Setup
7074	A Class A Amber Blisters, Small, PVdC	2 across and 8 down
7016	B Class A Amber Blisters, Small, Aclar	2 across and 8 down
7075	C Class A Amber Blisters, Medium, PVdC	2 across and 8 down
7014	D Class A Amber Blisters, Medium, Aclar	2 across and 8 down
7076	E Class A Amber Blisters, Large, PVdC	2 across and 8 down
7015	F Class A Amber Blisters, Large, Aclar	2 across and 8 down
7004	G Class A Amber Blister Block, Medium, Aclar	4 across and 4 down

Class A Labels for Blisters

- Proper Use:** Use with Class A Blisters to meet USP Class A package requirements
- Neat Application:** Foil labels are paper-topped. No adhesive is applied over the medication cavity or lift open tabs

Class A Laser Labels for Condensed & Micro Blisters

Packaged:

6123: 40 labels per sheet; 100 sheets per box; 4,000 labels total

6027: 35 labels per sheet; 100 sheets per box; 3,500 labels



total

Item #	Description	Dimensions W x H	Setup
6123*	A Class A Laser Labels for Condensed Blisters	1-1/2 x 1-3/16"	4 across; 10 down
6027*	B Class A Laser Labels for Micro Blisters	1-3/16 x 1-3/16"	5 across; 7 down
6462	Foam Sealing Tray fo Condensed Blisters	8-1/2 x 11"	-
6468	C Foam Sealing Tray fo Micro Blisters	8-1/2 x 11"	-
7088	4" Roller for Sealing Labels	4"	-
7089	8" Roller for Sealing Labels	8"	-

*Laser labels should be stored at 70° - 80°F and 50% relative humidity (±5%) away from heat sources and not exposed to direct sunlight. Labels should be stored in the room in which they will be printed at least 48 hours prior to printing. Not for use with thermal printers.

Class A Condensed Blisters & Micro Blisters

Condensed Blisters

- Smaller Footprint:** Allows blisters to fit and dispense trouble free from medications cassettes used in automated med dispensers
- Packaged:** 10 blisters per strip; 60 strips per pacakge; 1,600 blisters total

Micro Blisters

- Small Cavity:** Blister is designed to protect the smallest tablets
- Packaged:** 7 blisters per strip; 150 strips per pacakge; 1,050 blisters total

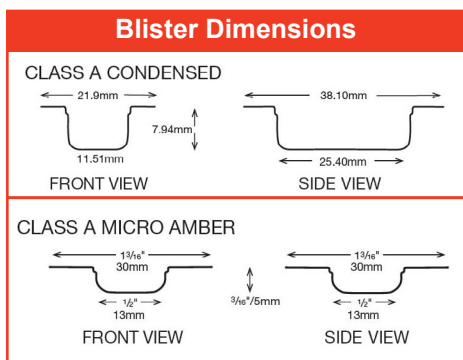
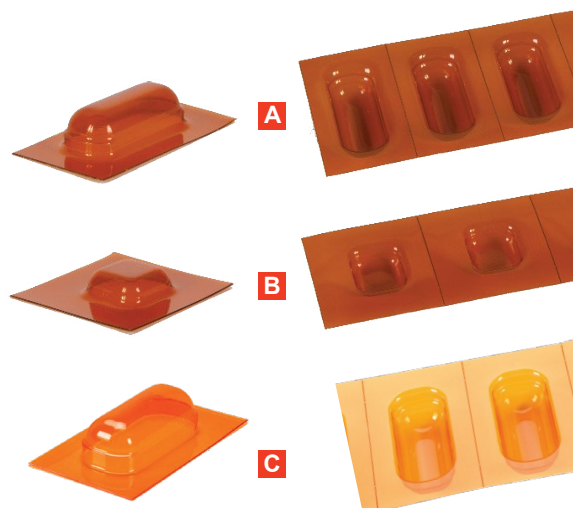

Item #	Description	Setup
7019	A Class A Amber Blisters, Condensed, Aclar	1 across; 10 down
7017	B Class A Amber Blisters, Micro, Aclar	1 across; 7 down
7079	C Class A Amber Blisters, Condensed, PVdc	1 across; 10 down

Class A Laser Labels for Round Blisters

- **Neat Application:** Foil labels are paper-topped. No adhesive is applied over the medication cavity or lift open tabs
- **Packaged:** 24 labels per grid; 2 grids per sheet; 100 sheets per box; 4,800 labels total



Item #	Description	Dimensions W x H	Setup	UPC
6125*	A Class A Laser Labels for Round Blisters	13/16 x 13/16"	6 across; 4 down	063636761257

*Laser labels should be stored at 70° - 80°F and 50% relative humidity (±5%) away from heat sources and not exposed to direct sunlight. Labels should be stored in the room in which they will be printed at least 48 hours prior to printing. Not for use with thermal printers.

Foam Sealing Trays & Rollers for Round Blisters

- **Expedite Filling & Sealing:** Holds Class A round Blisters in place

Item #	Description	UPC (063636)
6464	A Foam Sealing Tray for Deep Round Blisters	064648
6461	Foam Sealing Tray for Shallow Round Blisters	764616
7088	4"W Roller for Sealing Labels	770884
7089	B 8"W Roller for Sealing Labels	770891

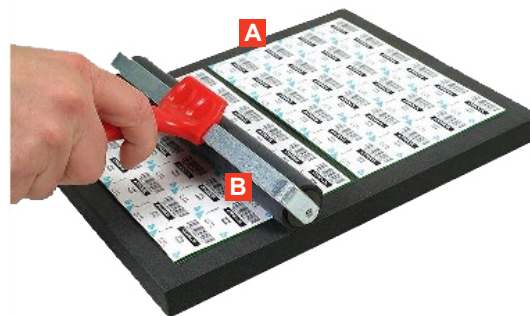

Class A Round Blisters

- **Construction:** PVdc
- **Colour Options:** Blisters are available in Amber, Green & Blue
- **Special Features:** Amber & Green blisters meet USP requirements for protection of UV light-sensitive medication. Blue Blisters do not provide UV light protection
- **Packaged:** 24 Blisters per sheet' 100 sheets per package' 2,400 blisters total

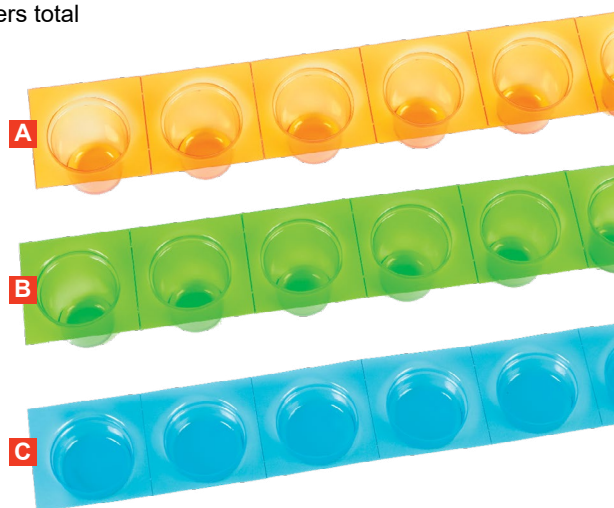
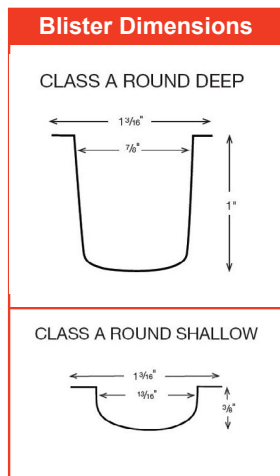

Item #	Description	Setup	Colour
7024	A Class A Round Deep Blisters	6 across; 4 down	Amber
7025	B Class A Round Deep Blisters	6 across; 4 down	Green
7026	Class A Round Deep Blisters	6 across; 4 down	Blue
7021	Class A Round Shallow Blisters	6 across; 4 down	Amber
7022	Class A Round Shallow Blisters	6 across; 4 down	Green
7023	C Class A Round Shallow Blisters	6 across; 4 down	Blue

Class B Labels for Blisters

- **Proper Use:** Use with Class B Blisters to meet USP Class B package requirements.
- **Neat Application:** Foil labels are paper topped. No adhesive is applied over the medication cavity or lift open tabs.
- **Color Options:** 6118 Laser Labels are available in White and Yellow.

Packaged:

6123 and **6118:** 40 labels per sheet; 100 sheets per box; 4,000 labels total

6122: 28 labels per sheet; 100 sheets per box; 2,800 labels total

17295: 1,600 labels per roll total

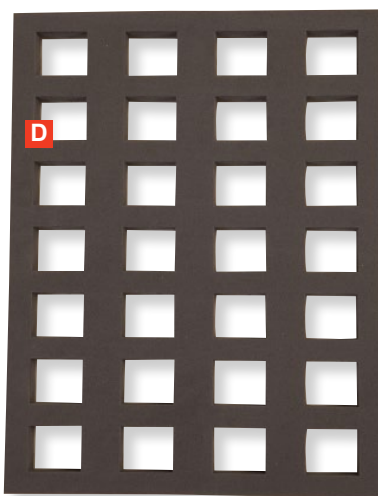
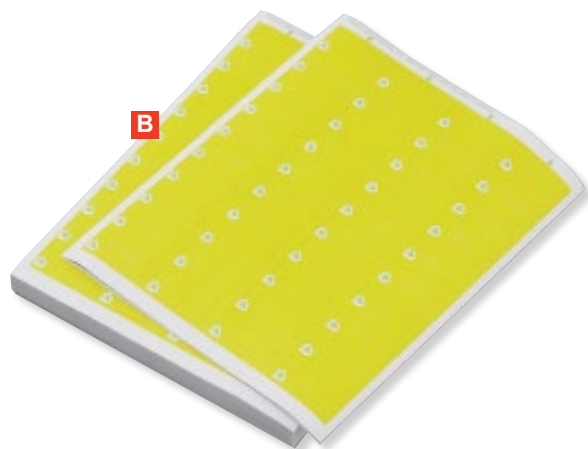

Item #	Description	Dimensions W x H	Setup	Qty
6123	A Class B Laser Labels for Condensed Blisters	1½ x 1⅜	4 across; 10 down	4,000
6118	B Class B Laser Labels for Keyhole S, M, L Blisters	1¼ x 1	4 across; 10 down	4,000
6122	C Class B Laser Labels for X-Large Blisters	1¼ x 1½	4 across; 7 down	2,800
6462	Foam Sealing Tray for Condensed Blisters	8½ x 11		1
6470	Foam Sealing Tray for S, M, L Blisters	8½ x 11		1
6469	D Foam Sealing Tray for X-Large Blisters	8½ x 11		1
7088	E 4"W Roller for Sealing Labels	-		1
7089	8"W Roller for Sealing Labels	-		1

Class B Amber PVC Blisters

- Proper Use - The combination of Class B Blisters and Labels meets USP Class B package requirements.

Packaged:

7006, 7013, 7012, 7011: 20 blisters per strip; 125 strips per package; 2,500 blisters total

7007: 10 blisters per strip; 250 strips per package; 2,500 blisters total

7010: 14 blisters per strip; 180 strips per package; 2,500 blisters total

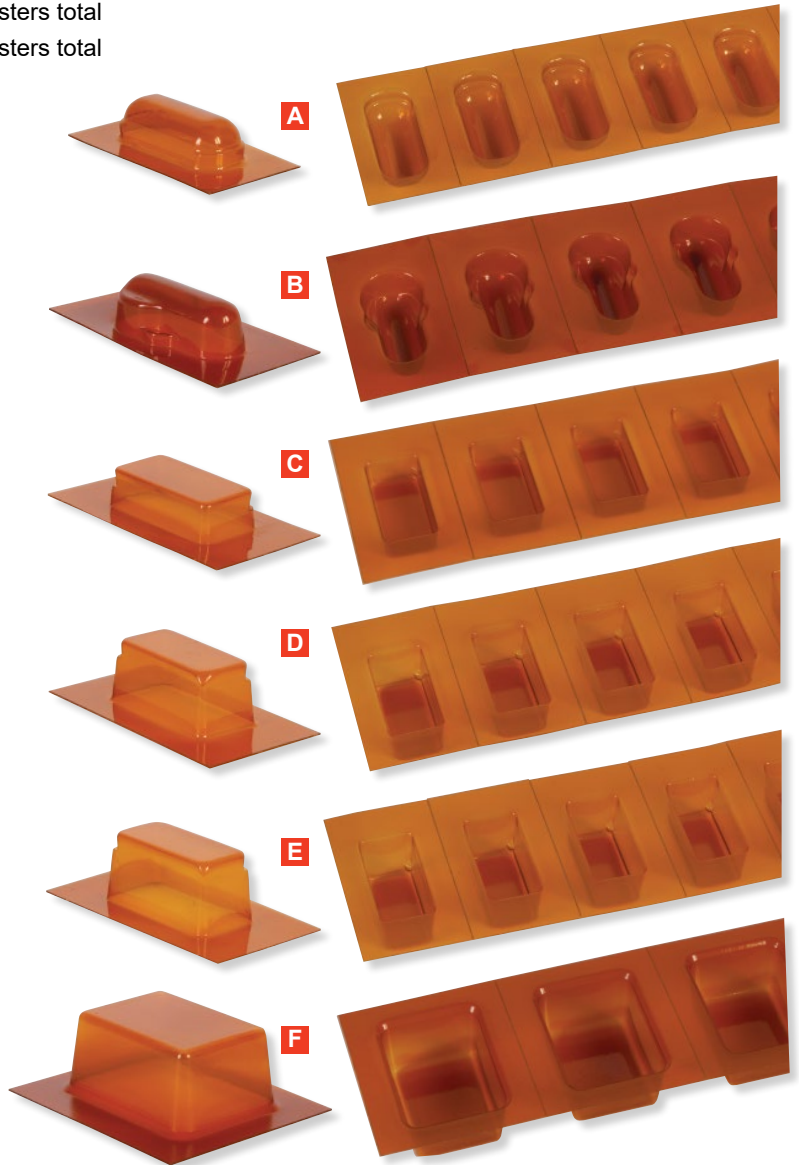
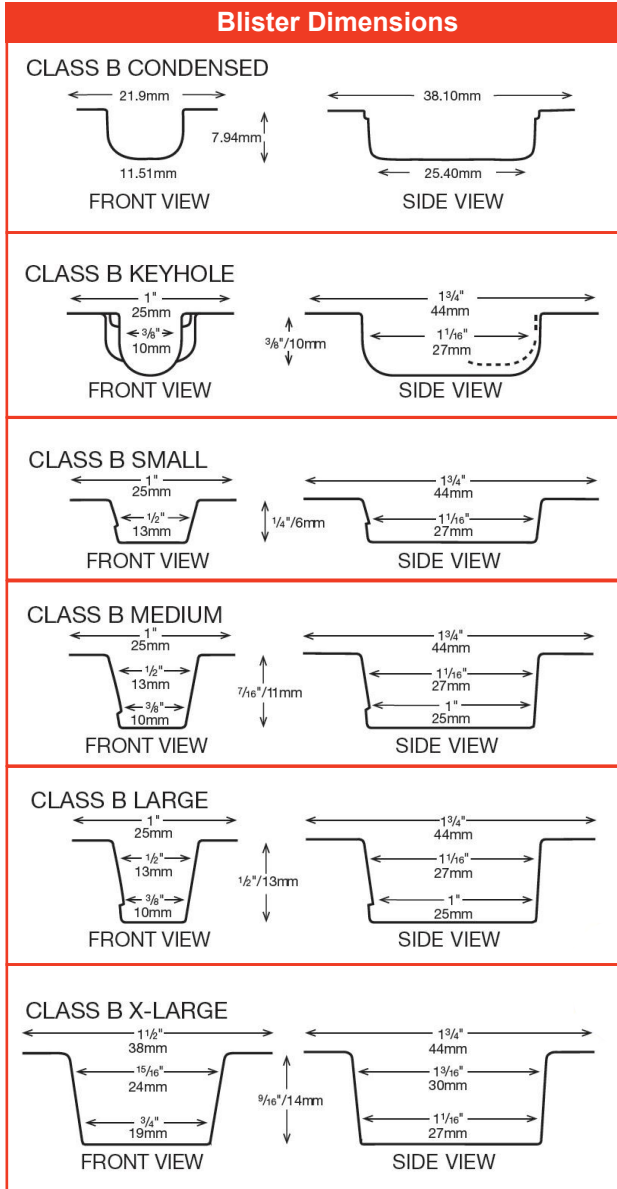

Item #	Description	Setup	Qty
7007	A Class B Amber Blisters, Condensed, PVC	1 across; 10 down	2,500
7006	B Class B Amber Blisters, Keyhole, PVC	2 across; 10 down	2,500
7013	C Class B Amber Blisters, Small, PVC	2 across; 10 down	2,500
7012	D Class B Amber Blisters, Medium, PVC	2 across; 10 down	2,500
7011	E Class B Amber Blisters, Large, PVC	2 across; 10 down	2,500
7010	F Class B Amber Blisters, X-Large, PVC	2 across; 7 down	2,500

Ointment Blisters, Labels & Sealing Trays

- **Convenient:** Package and dispense small volumes of ointments in easy-to-use unit dose blisters. Small Ointment Blisters hold approximately 1.2mL; Large Ointment Blisters hold approximately 1.8mL.
- **Easy-to-Fill:** Ointment Blister Filler/Sealing Tray is a two-piece system that uses an acrylic base to hold ointment blisters and an overlay to prevent ointment from spilling onto blister edges. Color overlay provides an easy visual cue for mess-free filling.

Ointment Blisters: 12 per sheet; 100 sheets per package; 1,200 blisters total; 4 across, 3 down

Laser Labels for Small Ointment Blisters: 12 labels per grid; 2 grids per sheet; 100 sheets per box; 2,400 labels total

Laser Labels for Large Ointment Blisters: 12 labels per sheet; 100 sheets per box; 1,200 labels total

Foam Sealing Tray: Holds blisters in place during filling and label application.

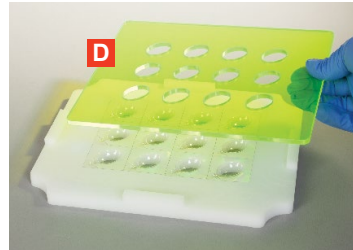
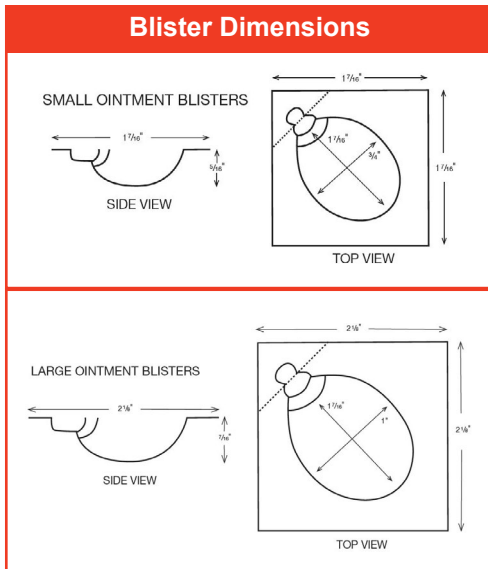
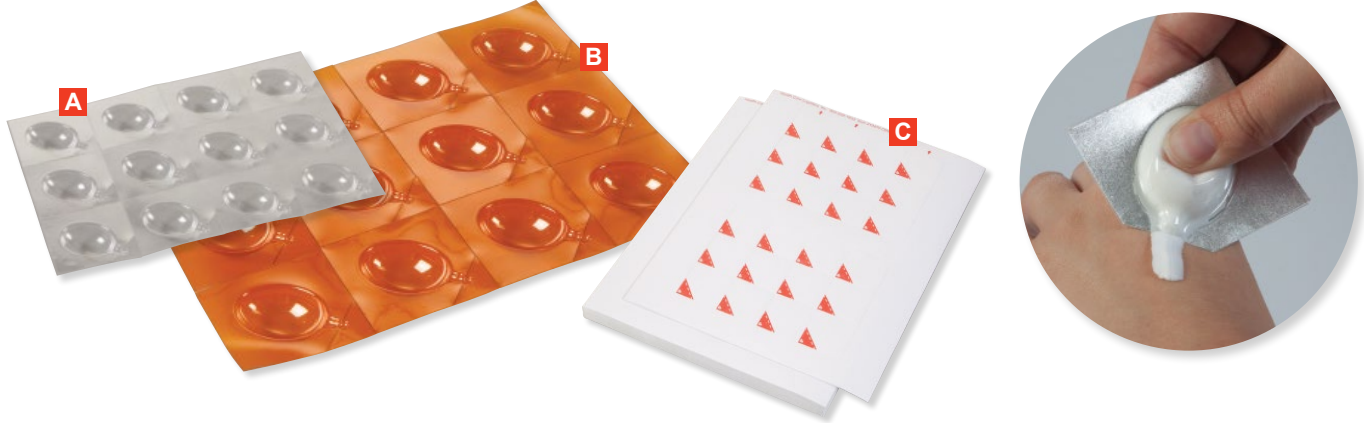

Item #	Description	Qty
19339	A Ointment Blisters, Small, Clear	1,200
19610	Ointment Blisters, Small, Amber	1,200
19611	Ointment Blisters, Large, Clear	1,200
19612	B Ointment Blisters, Large, Amber	1,200
19470	C Laser Labels for Small Ointment Blisters	2,400
19559	D Ointment Blister Filler/Sealing Tray, Small	1
19556	E Foam Sealing Tray for Small Ointment Blisters	1
19613	Laser Labels for Large Ointment Blisters	1,200
19615	F Ointment Blisters Filler/Sealing Tray, Large	1
19614	G Foam Sealing Tray for Large Ointment Blisters	1

Autoclavable Anti-Fatigue Mats

- Autoclavable - Mat provides comfort in any environment where the equipment and flooring must be sterilized.
- Material - Solid, non-porous rubber with textured surface
- Cleaning - Autoclavable up to 175°F (135°C)
- Quantity - Sold individually

Item #	Size	Depth	Colour	Weight
17712	2 x 3'	1/2"	● Grey	11-1/2 lbs.



Anti-Microbial Tile Top Mats

- Ideal for labs, pharmacies, and pharmaceutical manufacturing
- Combats fatigue with top to bottom anti-microbial protection
- Absorbs repeated compression and bounces back better than PVC sponge matting
- Safety beveled edges
- Made-to-order sizes and shapes available, contact our customer service team
- Thickness: 1/2" (13 mm)
- Material: PVC Surface with Anti-Microbial Nitrile Infused Sponge
- Temperature Range: -17 - 43° C (0-110° F)
- Tabor Abrasion: Federal Standard 191
- Coefficient of Friction: Dry = .78



Item #	Size	Depth	Colour	Weight
5290	2 x 3'	1/2"	● Grey	7.1 lbs.
5288	3 x 5'	1/2"	● Grey	18.1 lbs.

Deluxe Anti-Microbial Tile Top Mats

- Combats fatigue with top to bottom anti-microbial protection
- Absorbs repeated compression and bounces back better than PVC sponges
- Safety beveled edges
- Made-to-order sizes and shapes available, contact our customer service team
- Thickness: 7/8" (22 mm)
- Material: PVC Surface with Anti-Microbial Nitrile Infused Sponge
- Temperature Range: -17 - 43° C (0-110° F)
- Tabor Abrasion: Federal Standard 191
- Coefficient of Friction: Dry = .78
- Compression Deflection: ASTM D395-98/ 20%

Item #	Size	Depth	Colour	Weight
5754	2 x 3'	7/8"	● Black	8.1 lbs.
5756	2 x 3'	7/8"	● Grey	8.1 lbs.
5758	3 x 5'	7/8"	● Black	19.1 lbs.
5760	3 x 5'	7/8"	● Grey	19.1 lbs.



Rejuvenator Squared Workstation Mat

- Autoclavable - Mat provides comfort in any environment where the equipment and flooring must be sterilized.
- Material - Chemical and abrasion-resistant urethane. Textured back and surface offer non-slip grip. For dry work areas only.
- Cleaning - Mop with mild soap solution
- Quantity - Sold individually

Item #	Size	Depth	Colour
5762	3 x 5'	5/8"	● Black



Peel Away Dirt & Dust Control Mats

- Construction - Designed with multiple sheets. When top sheet is contaminated, pull it off and discard.
- Prevent Contamination - Tacky surface pulls dirt and dust off shoes before they can contaminate a cleanroom.
- Quantity: 30 sheets per mat; 4 mats per package; 120 sheets total

Item #	Size
17736	36 x 18"
7384	45 x 18"
17738	36 x 24"
17737	45 x 24"
17739	45 x 36"



Tacky Mats

- Construction: 2-mil thick sheets have adhesive coating with antimicrobial germicide that covers the full area of the mat
- Ready to use: mats remove dirt, dust and lint on contact from shoes
- Quantity: 30 sheets per mat; 4 mats per package; 120 sheets total
- Tab system helps remove top layer

Item #	Size
5601-01	34 x 18"
5602-01	45-1/2 x 18"
5603-01	24 x 34"
5605-01	46 x 36"
5606-01	60 x 36"



Hog Heaven Marble Mat

- Hog Heaven Marble mats feature the same excellent anti-fatigue qualities of a standard Hog Heaven mat, but with a smooth surface that allows workers to pivot freely
- Comfortable - High-density, closed-cell nitrile-blended cushion helps eliminate pressure to the lower back and legs, providing superior comfort; smooth top allows workers to pivot freely
- Safe - Certified high-traction by the National Floor Safety Institute (NFSI); sloped edges provide a safe transition from floor to mat
- Durable - Surface is molded, not glued, to the nitrile-blended cushion so it will not separate
- Easy to Clean - Smooth diamond-patterned vinyl surface is easy to clean
- Colour - Black, Grey and Blue

Item #	Size
MA4482X3K	24 x 36"

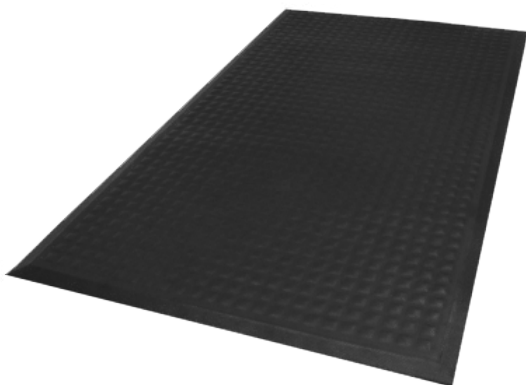

Complete Comfort Mat

- Complete Comfort II mats are anti-microbial anti-fatigue mats that can be autoclave sterilized and commercially laundered

Item #	Size
MA5942X3K	24 x 36"
MA5943X5K	36 x 60"

Heavy-Duty Stepstools

- Use to reduce risk of static posture; shift weight off one foot by resting it on stepstool
- 350 lb. capacity
- Wheels for easy relocation
- Dimensions: 16 x 13 inches (40.6 x 33 cm)

Item #	Colour
5202E	Beige
5202K	Black



Kango® Polyurethane Chairs

- Ergonomically designed seats and backrests provide lumbar support to reduce worker fatigue
- Seat and backrest covered with ½" thick polyurethane to inhibit punctures, tears and moisture absorption
- Center columns are pneumatic for almost effortless seat adjustment - simply pull up or push down on the lever to adjust
- Seats swivel 360°



Kango® High Polyurethane Chair

- Fully customize footrest and tilting back rest
- Sturdy aluminum foot rest, with chrome-plated base

Kango® Low Polyurethane Chair with Casters

- Lower chair height adjustment ideal for use at shorter workstations and tables
- Stable, 5-leg, chrome-plated base with casters



The Kango® Stand-Up Seat

- Ergonomic design reduces risk of fatigue from static posture
- Provides comfort and relief when performing jobs that require long periods of standing
- Ideal for pharmacy and hospital use
- Work standing up with legs stretched out and 2/3 of body weight resting on the seat, leaving only 1/3 of body weight to be absorbed by feet
- Keeps the back straight and ergonomically positioned, preventing shoulders from rounding
- Compact and easily transportable – includes carrying handle that allows the seat to be carried to another workstation or department



Item #	Description	Seat Height	Seat Width	Base
8421	A Kango® High Polyurethane Chair with Tilt & Footrest	22 - 31-1/2"	15-1/2"	22-1/2"
8424	B Kango® Low Polyurethane Chair without Tilt with Casters	17-3/4 - 22-3/4"	15-1/2"	22-1/2"
8420	C Kango® Stand-Up Seat	28 - 37"	15-1/2"	19"

Prescription Bags

- Convenient - Printed white paper bags in three sizes provide a convenient, cost-effective method of med packaging at the pharmacy and upon patient discharge. Largest size bag has a flat bottom for convenient filling.
- No Additional Fees - No order minimums and no set-up fees.
- Package - 100 per package

Item #		Dimensions (W x H x D)
19927	A	3-1/2 x 9-3/4 x 1-1/2"
19928	B	5 x 10 x 2"
19929		5-1/4 x 10-15/16 x 3-7/8"

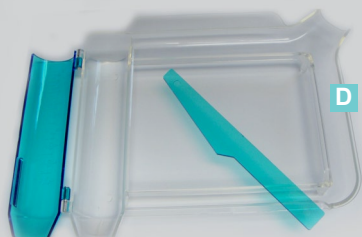
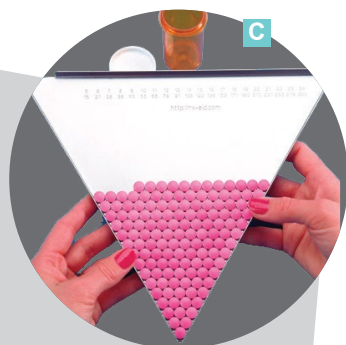

Fretwell's Triangle

- **Count regular shaped tablets with absolute accuracy and speed**
- Tablets glide easily on the stainless steel triangle
- Easy to clean

Item #	
FT1	C

Tablet Counters

- Plastic pill counting tray with clear lip handle and two corner spouts
- Effective way to keep organized with pill counting
- Includes plastic spatula (0.6 x 5½") to aid counting and transferring pills
- Recommended for right-handed users
- Measures: 8¼ x 6 x 1"

Item #	Colour
D-50	D Clear/Blue

Ergonomic Tablet Counters

- Includes spatula with ergonomic grip for easy handling and docking slot
- Designed to provide stability while counting tablets
- Deep blue colour allows pills and powder traces to contrast with tray
- Measures: 7¾ x 6.15 x 0.4"

Item #	Description
7147	Right-Handed
7148	E Left-Handed

Ambidextrous Tablet Counter

- Polyethylene pill counting tray for left or right handed users
- Spatula included
- Chute has a hinged cover for easy filling
- Measures: 7¾ x 6¼ x 1½"

Item #	Description
12261	F Left or Right Handed



Pharmacy Prescription Labels

- Preprinted in yellow & pink
- Smudge-free topcoat for clarity and durability
- Includes space to print up to 5 auxiliary labels
- Fully compatible with Kroll, Fillware, PharmaClik, and PropelRx systems - contact us to learn more
- Fully compatible with desktop printers such as Zebra ZD and GK. Contact us for more information

Item #		Dimensions (W x H x D)	Quantity
80411	A	2" x 4.5"	500 labels per roll
80412	B	3.375" x 4.25"	900 labels per roll

Stainless Steel Trays

- Heavy-gauge stainless steel tray can be used as a processing tray, medical supply organizing tray or a pass-through tray to the cleanroom
- Ideal for the pharmacy and lab use
- Seamless, non-corrosive metal tray has open corners and easy-grip handles and nests when empty
- View all stainless steel trays on page 32

Item #	Size	Dimensions (W x H x D)
18779	Small	11-11/16 x 2-1/16 x 6-3/8"
18665	Large	15 x 2-1/4 x 10-3/16"
18783	Shallow	12 x 1/2 x 9"



Rx Fill Tray

- Rx fill trays help keep individual prescription components together from arrival at the drug store to the prescription pick up counter
- Trays have easy-grip handles, nest when empty to save space
- Available in ● blue, ○ clear, ● green, ● red, ○ white and ● yellow - specify colour when ordering

Item #	Outside Dimensions (W x L x H)
17487	6-7/8 x 10-1/2 x 2-1/2"

Disposable Ampule Breaker

- Ampules can be safely opened by snapping the top of the ampule breaker to the side; thus breaking the top of the ampule off at the neck of the bottle - top of the ampule can then be discarded along with the ampule breaker
- Reduces the chance of finger cuts and cross contamination
- Disposable - eliminates need for sterilization
- Made out of polypropylene plastic
- Measures 2 x 1 1/4"

Item #	Quantity
10262	100



Hanging Prescription Bags

- Simplify prescription organization and retrieval
- Made of tough, clear 4 mil plastic for extreme durability
- Fits on any rod with a diameter of 1 cm or smaller

Item #	Size (W x H)	Qty
17540 A	10-1/2 x 7-1/2"	10
17541	12 x 9"	10
17542	14 x 12-1/2"	10

Wall Rack for Prescription Bags

- Simple solution to prescription organization
- Saves time, improves accuracy and enhances customer satisfaction
- Aluminum frame is 3 ft. wide and holds five 1 cm thick rods
- Each rod holds approximately 8-10 bags per foot or as many as 150 bags per rack
- Easy assembly, all hardware included
- Measures: 36" W x 57 1/2" H x 7 1/2" D
- Use with hanging bags and ID tags (sold separately)

Item #	Description	Qty
17543	Wall Rack for Prescription Bags	1 frame, 5 rods
17544 B	Green ID Tags	25

Bag Caddy for Hanging Prescription Bags

- Bag caddy designed for use with hanging prescription bags
- Holds up to 40 hanging prescription bags
- Ideal for use in pharmacies, to organize bags to be reused
- Measures: 6"W x 16.5"H x 7"D

Item #
17545 C



Multi-Cut Utility Shears

- Stainless steel blade, ideal for cutting bandages, dressing, fabric, or other tough material
- Colours available: ● black, ● blue, ● orange, ● pink, ● purple, ● red and ● yellow -specify when ordering

Item #
95-105 D

Handle Universal Scissors

- Stainless steel blade

Item #	Size
S3115 E	5-1/2"

Forceps

- Made of stainless steel

Item #	Description	Size
F4111	Dressing Forceps	4 1/2"
3039	Dressing Forceps	5 1/2"
F0111 F	Super Fine Straight Splinter Forceps	4 1/2"

Stock Prescription Receipt Pads

- Three popular sizes and designs
- Padded in 100's, sold in 1000's

Item #	Description	Qty
PRP-3 A	4-1/4 x 7"	10 pads of 100 sheets
PRP-6 B	3-1/4 x 7"	10 pads of 100 sheets
PP-8 C	4-1/4 x 6" (Hole Punched)	10 pads of 100 sheets



Rx Tape

- 3 sizes are individually packaged for convenient storage
- Two core sizes to fit different tape dispensers

Item #	Width	Length	Core Size
T1-1	1"	33 yards	1"
T1-3	1"	72 yards	3"
T1-5	1-1/2"	72 yards	3"
T1-7	2"	55 yards	3"

Tape Dispensers

Single Roll Tape Dispenser

- Accepts tape up to 1" wide
- Core adapter accommodates 1" and 3" cores

Double Roll Tape Dispenser

- Accepts tape up to 2" wide
- Core adapter accommodates 3" cores

Triple Roll Tape Dispenser

- Accepts tape up to 3" wide
- Can run 3 rolls of 1" wide tape or two rolls of 1 1/2" tape individually, 3" core

Item #	Description
TD1 D	Single Roll Tape Dispenser
GF2306 E	Double Roll Tape Dispenser
GF2336 F	Triple Roll Tape Dispenser

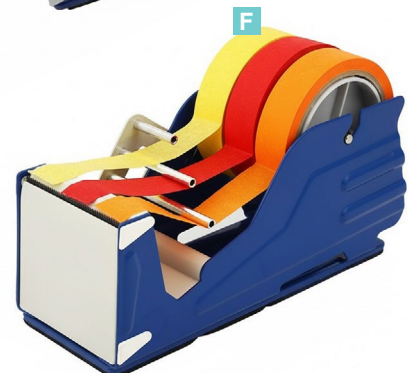

Prescription Boxes

- Storage - Use for storing archives or keep it on the counter for organizing incoming prescriptions
- Shipping - The paperboard box is shipped flat and is easy to assemble.

Item #	Size	L x W x H	Qty	UPC	
11194	A	Small	13 x 6 1/4 x 4 1/2"	1	063636711948
10196	B	Large	16 1/8 x 5 3/4 x 7 1/2"	1	063636701963



Prescription File Folders

- Keeps prescription slips organized for quick reference and storage
- Double fold file folders hold approximately 100 prescription sheets
- When folded, the spine is 1/2" deep and can be used to label or identify contents
- Measures: 5 1/2 x 13"
- Accommodates: 5 1/2 x 4" prescription slips

Item #	Qty
1976	C 100
19464	D 100

Tongue Depressors

- Sterile
- Individually wrapped tongue depressors
- Sterilized and wrapped in peel open envelope
- 100 per pack

Item #	Qty
T1100	100



Comfort Care Pack | CP970/830

- Each pack includes 1 Sleep Mask & 1 pair of Noise Reducing Ear Plugs (each set in Poly Bag)
- Quantity: 100 per case

Automated Pill Crusher

- Crush multiple pills at once!
- Simple to use: Just put your pills in the cups, place the cups in the machine and push one button to start the crush cycle. And you can use the cups to mix in apple sauce or other food stuff as desired.
- Improved medication dosing: Crush, mix & serve from same cup
- Finer powder: Easier swallowing, avoid swallowing chunks
- Includes 10 cups

Item #	Description
7300	Automated Pill Crusher, Generation 2
7310B	Cups for Pill Crusher (7300) (1000 per pack, 500 Top design and 500 Bottom design)



Powder Crush Automated Medication Crusher

- Saves time, eliminates the problem of cross contamination & crushes medications to a super-fine powder
- Battery operated: Powered by 2 long-lasting rechargeable batteries (charger included)
- Easy to Use: Reduces the chance of repetitive strain injuries for nurses and other users
- Dimensions: 3¼" W x 11" L x 3¾" H

Item #	Description	Quantity
PC300	Automated Medication Crusher	1
39-1000	Powder Crushing Bags	1000
39-8000	Powder Crushing Bags	8000

Silent Knight® Tablet Crusher & Pouches

- Clear plastic pouches safely contains pills during crushing process, eliminating cross contamination and unnecessary clean up
- Latex-free
- 7 mil thick polyethylene

Item #	Description	Qty
7414-31	Pouches, 2" x 4-3/4"	1000
7414-10	Pouches, 2" x 4-3/4"	100
7424-01	Silent Knight® 10-1/2 x 3 x 4-1/2"	1



Silent Knight®

- Quiet and powerful pill crusher - silently crushes tablets without disturbing patients
- Ideal for use during night or early morning shifts
- Features OxiTitan™ antimicrobial coating to help fight infections
- Can be cleaned with any disinfecting cleaner
- Crushes pills and tablets into fine powder- reduces risk of clogging feeding tubes
- Requires minimum force to crush tablets, reducing risk of wrist or arm injuries
- Storage compartment provides easy access to pouches

Stainless Steel Tablet Crusher

- Durable: Stainless steel crusher is designed for repetitive crushing. Crusher includes 48 cups.
- Two-Cup Crushing - Use one ½ oz. Paper Souffle Cup (7368) to hold tablets and another to cover. (Do not crush enteric coated tablets).
- Includes 48 crush cups

Item #	Dimensions L x W x H
7349-01	9 x 2-1/2 x 2-3/4"



White Powder Coated Tablet Crusher

- One Tough Crusher - Constructed using heavy-duty, white powder coated, die cast components and stainless steel fittings.
- Mountable - Metal Mounting Bracket (7356, sold separately) affixes the crusher to a counter or cart top.
- Two-Cup Crushing - Use one ½ oz. Paper Souffle Cup (7368) to hold tablets and another to cover. (Do not crush enteric coated tablets).

Item #	Description
7355	Metal Tablet Crusher 8-1/2" L x 3-1/2" W x 3" H
7356	Metal Mounting Bracket

Stainless Steel Tablet Pulverizer

- Powerful Crushing - Tablets are reduced to a fine powder that passes easily through various types of feeding tubes without clogging. Do not crush enteric coated tablets.
- Stays Put - 3" square base unit has a rubberized non-slip pad and features two drilled holes so the pulverizer can be permanently mounted.
- Note - This item is not a registered medical device.
- Cup Dimensions - 1¼"H x 1½" D

Item #	Description
7340	Tablet Pulverizer with Handle Separate
7344	Tablet Pulverizer with Handle Attached



Quiet Crusher

- Quiet: Crusher uses a rolling action which is quiet and crushes medication to a fine powder without all the noise (do not crush enteric coated tablets)
- Smart Construction: Reinforced metal-filled polycarbonate construction is designed to make the crusher lightweight, strong and durable
- Built-in Bag Storage: Dispensing box can be stored in the built-in holder on the back of the crusher to keep bags readily available
- Less Waste: 7 mil bags have curved bottoms to prevent power from sticking in corners
- Dimensions: 12"W x 3⅝"H x 3¾"D
- Includes 100 bags (Item #7414-10)

Item #	Description
12655	Quiet Crusher

The Ultimate Pill Crusher

- Easy Crushing: Ergonomic design lets users crush tablets with a gentle push of the handle. Spring design absorbs shock and vibration for quiet crushing
- No-Slip Design - Skid tape holds the unit steady.
- Two-Cup Crushing: Use one ½ oz. Paper Souffle Cup (7368) to hold tablets and another to cover. (Do not crush enteric coated tablets)
- Durable: Lightweight crusher is made of anodized, non-corrosive aluminum



Item #	Dimensions (W x H x D)
17120 A	9-13/16 x 5-1/2 x 3-15/16"

Easy Empty Crusher Bag

- Reduce Risk: Durable polyethylene bags hold multiple tablets in place during crushing and help prevent cross contamination.
- Easy to Use: Conveniently packaged in a dispensing box.
- Quick Delivery: Tear and remove the 8-mil bag's perforated strip to easily empty from the bottom! Shorter traveling distance for medication allows for quicker and complete delivery.
- Less Waste: Funnel shaped bag guides crushed medication out of the bag to prevent powder from sticking in corners.
- Convenient Access: Dispensing box can be stored in the holder on the back of the Quiet Crusher.
- Thickness: 8-mil

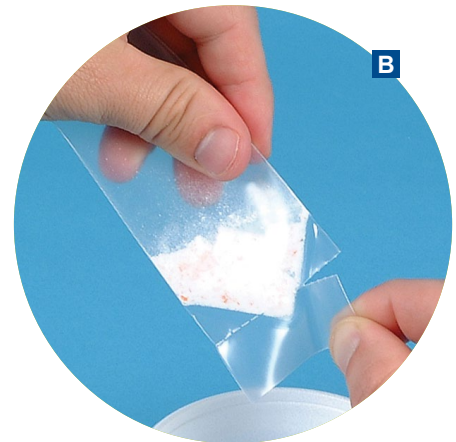

Item #	Dimensions (W x H)	Qty
12679 B	1-13/16" x 4 11/16"	100

Pill Crusher

- For easy and effective tablet crushing
- Includes 2 storage compartments
- Latex & BPA free

Item #	Dimensions (W x L x H)
PS7346 C	2 x 2 x 3"



Pill & Tablet Splitters

- Built-in storage compartment
- Can be custom imprinted
- Latex & BPA free

Item #	Description
PS7345 D	Pill & Tablet Splitter
PS7325 E	Deluxe Pill & Tablet Splitter with non-slip grip surface
PS7305 F	Safety Pill & Tablet Splitter with Blade Guard



Paper Cups

- Paper: This cup is cost efficient & disposable
- Tightly wound rims and recessed base helps prevent tipping or spilling on counter tops
- Quantity: 250 cups per sleeve; 4 sleeves/package, 1,000 cups total Box pleat design for durability

Item #	Capacity	Qty
7368	1/2 oz.	1000
7369	A 1 oz.	1000



A



B



C

Graduated Medication Cups

- ISMP recommended: mL only Medication Cups eliminate confusion between mL and teaspoon markings and reduce the risk for dosing errors. Clear cups with FDA -compliant food-grade ink improve visibility, accuracy and patient safety initiatives as well as medication compliance
- Easy to Use: Cup features a wide mouth that allows for easier drinking and filling of liquid medication, and can accommodate multiple and large tablets/capsules
- Efficient: Lids protect medication from contamination and spilling

Item #	Description	Size	Qty
5149-01C	B Wide Graduated Cups	30 mL	2,000
5148-01	Lids for Wide Cups	-	2,000
5165	C Narrow Graduated Cups	30 mL	400
5160	Lids for Narrow Cups		400

Plastic Cups

- Item # 7360 is recommended for methadone dispensing

Item #	Description	Size	Qty
7364	D Graduated	1 oz.	1000
7362	Graduated	2 oz.	1000
7360	Not Graduated	3-1/2 oz.	100
7361	Not Graduated	5 oz.	100



D

Wax Paper Cups

- Disposable cups
- Wax-treated paper to help increase durability and prevent leaks

Item #		Size oz.	Qty
7363	E	3 oz.	2400
7366	F	5 oz	1200



Medication Cup Transport Tray

- Transport tray keeps multiple medication cups and syringes organized on one tray for easy transport during medication passes
- Made of white impact resistant plastic
- Impact-Resistant: Plastic tray holds 20 cups
- Measures: 13¼"W x 1½"H x 14⅝"D

Item #

5145

Medication Crushing/Cutting Cups

- Two in One - Combines the convenience of cutting and crushing tablets in one tool
- Easy Cutting - Cut by placing a tablet in the triangular-shaped area of the cutter and pushing down on the top cup to split the tablet
- Easy Crushing - Cups are designed for use in pairs with a grinding area located between the cup surfaces. Top cup snaps onto bottom for mixing
- Durable - Cups are constructed of thick, heavy-duty, plastic designed to withstand heavy grinding pressure
- Note - This item is single-use
- Dimensions: 2"W across top and 1"W across the bottom x 1¾"H

Item #	Qty
7337-01	1 Set
7337-10	20 Sets



Metro® Utility Cart

- 3 shelves – middle shelf can adjust in 1" increments
- Ergonomic handle designed for easy use
- Smooth surfaces are designed to resist staining and can be easily wiped clean
- All-polymer shelf will resist corrosion
- Features a 13 mm raised ship's edge design to contain products or spills

Item #	Dimensions (L x W x H)	Capacity per shelf	Colour
5267E	36-3/4 x 25 x 36"	150 lbs.	● Grey



Rubbermaid® Utility Cart

- 3 shelves
- Handles on both ends
- 4 swivel casters
- Middle and bottom shelves have inverted lips to contain products and prevent items from falling off
- Made of plastic and aluminum
- Available in grey, off-white and black

Item #	Dimensions (L x W x H)	Capacity per shelf	Colour
5400-01	40-1/2 x 20 x 37-3/4"	100 lbs.	○ White

Metro Lifeline Crash Cart Boxes

- Designed to fit Metro Lifeline Crash Cart drawers
- Ideal for organizing medications and supplies in the drawer
- Designed for easy removal and access during a "code" situation as well as ensuring the replenishing of stock
- Compatible with security seals for added security (sold separately)
- Dividers and foam are available for customization (sold separately)
- Shallow box measures: 19" W x 2-1/2" H x 15"
- Deep box measures: 19" W x 5-1/2" H x 15"

Item #	Size	Description
1873-01	A Shallow	Box with Clear Slide-In Lid
1870-01	Shallow	Box (only)
1876-01	B Deep	Box with Clear Slide-In Lid
1875-01	Deep	Box (only)
1872-01	C -	Clear Slide-In Lid (only)
1871-01	D -	Amber Slide-In Lid (only)

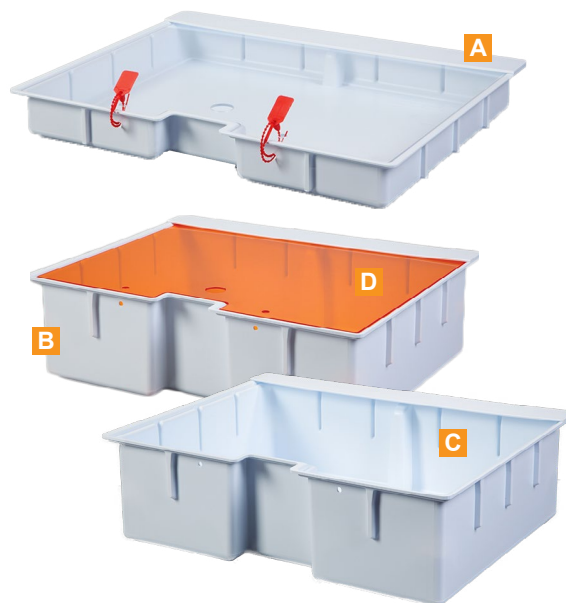

Rubbermaid® Large Utility Carts & Accessories

- Versatile, functional carts for easy transport
- Easy-to-clean smooth surfaces
- Strong, lightweight designs
- Quiet casters and plastic construction help eliminate noise
- Convenient handle on each end assists in complying with HACCP guidelines
- Made of plastic
- Small or large waste bin attachment, available separately



Item #	Details	Dimensions (L x W x H)	Capacity	Colour
5261S	A Utility cart	31-1/2 x 16-1/4 x 37"	200 lbs.	Off-White
5261P	Utility cart	31-1/2 x 16-1/4 x 37"	200 lbs.	Platinum
5254	Small waste bin	9 x 13 x 8"	15.1 L	Black



Stainless Steel Bench with Storage

- Easy-to-Clean - Provides a hospital-grade seating solution in cleanroom gowning areas. Allows user to sit while donning appropriate cleanroom attire
- Sturdy - 16-gauge stainless steel for durability and long life. Includes 8 storage compartments and 6 dividers for PPE apparel
- Adjustable - Feet provide up to 3" of additional height
- Weight Capacity - 750 lbs

Item #	Dimensions (W x H x D)
19546	36 x 19 x 18"

Equipment Tags

- Status Indication - Cardstock tags allow users to easily indicate product status. Use to identify items such as carts, trays or scales that have been cleaned or repaired and are ready for use.
- Ready to Use - Wire ties (included) easily attach tags to nearly any item.
- Quantity - 50 per pack
- Dimensions - 2 5/16"W x 4 3/4"H

Item #	Description	Colour
20745	B Equipment Tags, Clean	Green
20746	C Equipment Tags, Dirty	Red
20747	Equipment Tags, Blank	Ivory

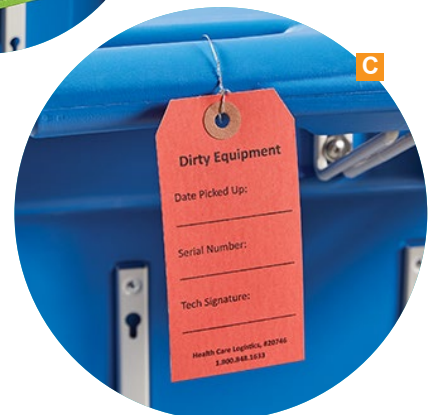



Stainless Steel Carts

Item #	Shelves	Casters	Shelf Clearance	Dimensions (W x H x D)	Capacity	Assembly Required
18751	A	2	4 Swivel	25"	36 x 34 x 22"	600 lbs. Yes
18752	B	3	4 Swivel	11"	36 x 34 x 22"	600 lbs. Yes
18753	C	4	4 Swivel, 2 Locking	12"	36 x 48 x 22"	600 lbs. Yes
5295	D	3	4 Swivel, 2 Locking	11-3/4"	33 x 32-1/2 x 17-1/4"	600 lbs. Yes
17827	E	3	4 Swivel, 2 Locking	10-1/2"	29-1/2 x 35-7/16 x 15-3/4"	200 lbs. No
11875	F	3	4 Swivel	10-7/8"	27-1/2 x 33-3/8 x 16-1/4"	300 lbs. No
11876	G	3	4 Swivel	8-1/2"	18-3/4 x 30-1/8 x 16-3/4"	200 lbs. No

Guard rail around cart shelves prevents cart items from sliding off during transport

Crash Cart Boxes with Handle

- Built-in handle allows for easy access in cart or when carried to and from supply areas or alternate care sites
- Boxes and dividers can be colour-coded by department, medication, age group, supplies, floors, units, etc.
- Amber or clear slide-in lids are available with the boxes or individually
- Dividers will provide greater organization and accessibility of supplies (sold separately)
- Holes on boxes allow security seals to be used for control and documentation (sold separately)
- Available in ● blue, ● light blue, ● green, ● red, ● yellow and ○ white – specify colour when ordering
- Full-size measures: 21¾" W x 2⅝" H x 15¼"D
- Half-size measures: 10⅝" W x 2⅝" H x 15½"D



Item #	Size	Description	Lid Colour
1867	Full	Box (only)	-
1868	Full	Slide-In Lid (only)	○ Clear
3132	Half	Box with Slide-In Lid	● Amber
3131	Half	Box (only)	-
3133	Half	Slide-In Lid (only)	○ Clear



Amber lids are ideal for storing light-sensitive medication



Crash Cart Boxes

- Enhanced durability, made of impact-resistant polystyrene plastic
- Design includes built-in handle for easy gripping
- Available with two styles of lids: Slide-in (more durable) or Lift-off lids (easier to remove in a code procedure)
- Slide-in lids are available in clear or amber; lift-off lids are available in clear (amber meets light resistance specifications)
- Crash cart security bags can be used instead of, or in addition to lids
- Lids can be secured using pull-tight seals
- Add dividers to maximize organization and supply accessibility
- Full-size box measures: 21¾" W x 2⅝" H x 15¼" D
- Half-size box measures: 10⅝" W x 2⅝" H x 15½" D

Item #	Size	Description	Lid Colour
1816	Full	Box with Slide-In Lid	○ Clear
1850	A Full	Box with Slide-In Lid	● Amber
1817	Full	Box with Lift-Off Lid	○ Clear
1814	Full	Box (only)	-
1819	Full	Lift-off Lid (only)	○ Clear
1101	Full	Dividers: 3 long, 4 short (Creates up to 20 compartments)	○ White
3020	B Half	Box (only)	For use with Slide-in Lid
3001	Half	Box with Lift-off Lid	○ Clear
3013	Half	Box (only) For use with Lift-off Lid	-

Cut Foam Options

- Organize Contents: Customize transport boxes, med kits, crash carts, trays, drawers and more so contents are easy to identify. Helps protect items from possible breakage.
- Die Options & Cut to Your Design: Different die shapes are available for ampules, vials, boxes and other special shapes (may require additional one-time charge for a cutting die). Send us your layout and we'll cut the foam to your specification.
- Details: There is a design charge to create the template. We will send a proof for approval prior to completing the order.
- Fast Shipping: most orders ship in 5 working days from approval of final layout drawing

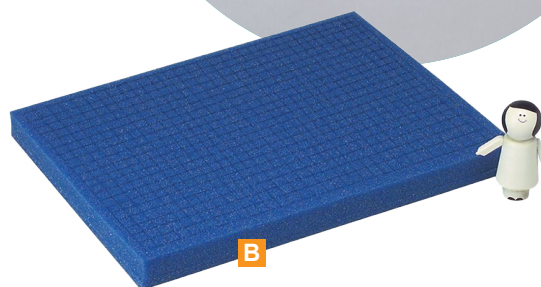

Pinch & Pull Foam Grid Pads

- Customize - Pull out the prescored 1/2" cubes to create spaces as needed
- Prevent Breakage - Quick and affordable way to protect and organize vials, bottles, boxes, etc. in cart drawers, boxes, and more

Item #	Description	Dimensions (W x H x D)
1926-01	A Pinch & Pull Foam Grid pad, 1-1/4" H	16 x 1-1/4 x 12-1/8"
1975-01	B Pinch & Pull Foam Grid pad, 2" H	16 x 2 x 12-1/8"

Amber Security Bags for Full-Size Crash Cart Boxes

- Easy to Identify - Bags are pre-printed with white letters that state ATTENTION: PEDIATRIC ONLY. These bags allow crash cart boxes to be quickly identified.
- Convenient - Self-sealing adhesive closure. Perforated opening cannot be resealed once opened. Tears may indicate discrepancy in kit contents.
- Quick Retrieval - In code situations, bags open easily and quickly by tearing at the highlighted perforations.
- Perforations - 1 center, 1 end
- UV Light Blockage - Amber security bags will protect light sensitive medications.
- Thickness - 2-mil
- Quantity - 20 per pack



Item #	Description	Dimensions (W x H)
7534	C Attention Pediatric Only	29 x 20"
7535	D Attention Adult Only	29 x 20"

Self-Sealing Crash Cart Bags

- Self-sealing, tamper evident – simply remove paper strip at top to access adhesive; fold over to seal bag
- Bags can be easily opened by tearing the highlighted perforations - ideal for quick access or code situations
- A tear in the bag indicates prior emergency or tampering
- 2 mil thick
- 20 per package



Item #	Description	Perforation	Dimensions (W x H)	Colours
1714	Security Bags for Deep Metro® Lifeline™ & Waterloo® CCB	1 center	31 x 21-1/2"	Clear
19840	Amber Security Bags for Deep Metro® Lifeline™ & Waterloo® CCB	1 center	31 x 21-1/2"	Amber
7512	Security Bags for Full-Size CCB	1 center	29 x 20"	Clear
20501	A Amber Security Bags for Full-Size CCB	"H"	29 x 30"	Amber
7505	Security Bags for Full-Size CCB	"H"	29 x 20"	Clear
7515	Security Bags for Full-Size CCB	1 center, 1 end	29 x 20"	Clear
7509	Security Bags for Full-Size CCB w/ Blue Border	1 center, 1 end	29 x 20"	Clear/Blue
7510	Security Bags for Full-Size CCB w/ Red Border	1 center, 1 end	29 x 20"	Clear/Red
7568B	Security Bags for Full-Size CCB Blue or Red	1 center, 1 end	29 x 20"	Blue
7568R	Security Bags for Full-Size CCB Blue or Red	1 center, 1 end	29 x 20"	Red
7506	Amber Security Bags for Full-Size CCB	1 center, 1 end	29 x 20"	Amber
7534	Attn: Pediatrics Only Amber Security Bags for Full-Size CCB	1 center, 1 end	29 x 20"	Amber
7535	Attn: Adult Only Amber Security Bags for Full-Size CCB	1 center, 1 end	29 x 20"	Amber
7517	B Security Bags for Half-Size CCB	1 center	22 x 14"	Clear
7502	Amber Security Bags for Half-Size CCB	1 center, 1 end	22 x 14"	Amber
7500	Security Bags for Blue Bell CCB	1 center	18-1/2 x 15-1/2"	Clear
7503	Security Bags for Top Compartment Metro® Lifeline™ CCB	1 center	21-1/2 x 20"	Clear

Security Bag Item

Cart Box Item #	1714	19840	7512	20501	7505	7515	7509	7510	7568	7506	7534	7535	7517	7502	7500	7503
Shallow CC Box 1870-01, 3215			✓		✓	✓	✓	✓	✓	✓	✓	✓				
Deep CC Box 1875-01, 3219	✓	✓														
Full-Size CC Box 1814 & 1867			✓	✓	✓	✓	✓	✓	✓	✓	✓	✓				
Third-Size CC Box 3150													✓	✓	✓	
Half-Size CC Box 3020, 3013, 3131													✓	✓	✓	
Metro Top Compartment CC Box 3057 & 3211																✓

Thermometers with glycol-filled bottle probes

- Recommended to meet the National Vaccine Storage and Handling Guidelines
- 10 ml & 5 ml glycol bottle probes insulate sensors from rapid temperature changes, ideal for mimicking vaccine temperatures



Thermometers with enclosed temperature buffered ambient sensor probes

Ideal for the following:

- Freezers
- Water baths
- Heating blocks
- Incubators
- Refrigerators



Item #	Description	5 ml Probes	10 ml Probes	Ambient Probes	Resolution	Accuracy	Current/Min./Max. Temp. (with reset button)	Ambient Room Temp.	High/Low Alarm	Calibration Certificate	Low Battery Icon
10364	TraceableLive® Wifi Datalogging Thermometer		✓		0.01°C	± 0.25°C	✓		✓	✓	✓
14140	Traceable® Refrigerator/Freezer Thermometer		✓		0.1°C	±0.5°C	✓	✓	✓	✓	✓
14141	Traceable® Digital Humidity/Temperature Meter				1°C	±1°C			✓		
14144	Traceable® Refrigerator/Freezer Thermometer	✓			1°C	±1°C	✓	✓	✓	✓	✓
10366	Traceable® Dual Thermometer			✓	1°C	±1°C	✓	✓	✓	✓	✓
10367	Traceable® Refrigerator/Freezer Thermometer			✓	1°C	±1°C	✓	✓	✓	✓	✓
10368	Traceable® Refrigerator/Freezer Thermometer		✓		1°C	±1°C	✓	✓	✓	✓	✓
10369	Traceable® Dual Bullet Probe Thermometer			✓	0.1°C	±1°C	✓	✓	✓	✓	✓
17751	Traceable® Jumbo Thermometer		✓		0.1°C	±1°C	✓	✓	✓	✓	✓
17752	Traceable® Jumbo Thermometer	✓			0.1°C	±1°C	✓	✓	✓	✓	✓
17750	Traceable® Jumbo Thermometer			✓	0.1°C	±1°C	✓	✓	✓	✓	✓
17988	Traceable® High-Accuracy Thermometer		✓		0.01°C	±0.3°C	✓		✓	✓	✓
17989	Traceable® High-Accuracy Thermometer, dual probe		✓		0.01°C	±0.3°C	✓		✓	✓	✓
17990	Traceable® High-Accuracy Thermometer, dual probe			✓	0.01°C	±0.3°C	✓		✓	✓	✓
19195	Traceable® Memory-Loc™ Datalogger, single probe		✓		0.01°C	±0.25°C	✓		✓	✓	✓
19196	Traceable® Memory-Loc™ Datalogging Thermometer, dual probe		✓		0.01°C	±0.25°C	✓		✓	✓	✓
19197	Traceable® Excursion-Trac® Datalogger, single probe		✓		0.01°C	±0.25°C	✓		✓	✓	✓
19198	Traceable® Excursion-Trac™ Thermometer, dual probe		✓		0.01°C	±0.25°C	✓		✓	✓	✓
19465	Fridge-Tag® Storage Temperature Monitor with USB			✓	0.1°C	±0.5°C	✓		✓	✓	✓

Vaccine Temperature Monitoring Requirements:

- The National Vaccine Storage and Handling Guidelines (2015), as well as many provincial guidelines, require manual documentation of vaccine temperatures, where the: current, minimum and maximum refrigerator temperatures, and the ambient room temperature must be recorded at the beginning and end of each day (min/max temperatures must be reset after each recording) – log templates are available, refer to the guidelines, or contact us for assistance
- The digital display should be placed on the **outside** of the refrigerator (Ontario requires a display with a minimum resolution of 0.1° C), with the probe in the centre of the refrigerator (preferably in a vaccine box)
- Bottle probes (bio-safe glycol fluid bottle probes) are recommended for a more accurate reading
- Reset button required to reset the minimum and maximum temperature after each recording
- Thermometers should be set to alarm if temperatures fall to 3°C or rise to 7°C to signify approaching out of range
- Thermometers should be checked for calibration at least annually, and it is recommended they be calibrated within $\pm 0.5^{\circ}\text{C}$ ($\pm 1^{\circ}\text{F}$) of accuracy
- Thermometers should have a low battery indicator, and batteries should be replaced every 6 months



General Vaccine Storage Requirements:

- ✓ Maintain required vaccine storage temperatures
- ✓ Hold sufficient inventory
- ✓ Have a calibrated temperature-monitoring device inside each storage compartment
- ✓ Refrigerator is dedicated to the storage of vaccines only
- ✓ Be placed in a secure location
- ✓ Recommended thermometer calibration should be accurate within $\pm 0.5^{\circ}\text{C}$ ($\pm 1^{\circ}\text{F}$)
- ✓ Record refrigerator temperature twice daily
- ✓ Contact public health officials if vaccines are exposed to temperatures outside the recommended range

Stat Temp 3.0 NIST Certified Refrigerator / Freezer Sensor

- Encased Sensor - Sensor (21266 includes one sensor; 21268 includes two sensors) is housed inside an unbreakable silicone case that can be placed within the wires on most refrigerator and freezer shelves to minimize obstructions.
- Data Logging - Wi-Fi-enabled temperature monitor (included) offers unlimited readings with user-selected logging rate from every 5 minutes up to every 30 minutes.
- Note: Monitors work with 2.4GHz Wi-Fi networks only.
- Mesh-Enabled Connectivity - Devices communicate with each other to extend coverage and improve network reliability, even in challenging hospital layouts. This allows sensors to be installed in distant or obstructed areas without requiring direct Wi-Fi access.
- Set-Up - Once connected to Wi-Fi, the unit can be added to the Stat Temp website, stat-temp.io. The sensor will automatically be added to the dashboard.
- Mobile-Friendly Reports - Cloud-based storage allows instant access to reports from a computer, tablet, phone or other connected device for process, compliance or inspection.
- No Fees - There is no subscription fee for Stat Temp.
- No Limits - Users have unlimited cloud storage and can have multiple Stat Temp monitors linked to their portal.
- Online Portals - Create portals on the Stat Temp website for locations; view all units being monitored or sort to show less (ex. location only).
- Permissions - Set user-defined permissions based on shifts or roles.
- Alerts - Configure real-time and user-defined alerts via text, email or phone call with forced acknowledgment of solutions. Example: Call Calvin, Fred and Cindy
M-F, 8 a.m. – 5 p.m.; email Annie and text Tim
M-F, 5 p.m. – 8 a.m.
- Power Source - Uses a standard USB-C plug. No batteries to change out.
- Loss of Power - 3-day battery backup
- Min/Max Log - Provides min/max data for the last 24 hours.
- NIST - Includes a 4-year NIST certificate.

Item #	Description	Temperature Range	Temperature Accuracy	Dimensions (W x H x D)
21266	Single Sensor	-50°C to 50°C (-58°F to 122°F)	+/-0.2°C	4" x 2½" x 1"
21268	Double Sensor	-50°C to 50°C (-58°F to 122°F)	+/-0.2°C	4" x 2½" x 1"
21270	Ambient Sensor	-40°C to 85°C (-40°F to 185°F)	+/-0.2°C	4" x 2½" x 1"
21272	Ultra-Low Sensor	-100°C to -50°C (-148°F to -58°F)	+/- 0.5°C	4" x 2½" x 1"



Traceable® Thermometers:

- Triple display simultaneously shows the current, minimum and maximum temperature reading
- Includes Traceable® certificate from ISO 17025 calibration laboratory, accredited by A2LA, valid for 1 year - recalibration is the customer's responsibility, contact us for assistance
- Alarm alerts when temperature rises or falls outside set point
- Low battery symbol indicates when batteries should be replaced
- Reads temperatures ranging from - 50° - 70° C (-58° - 158° F)
- Includes all necessary batteries and mounting equipment (flip stands, wall mounts, Velcro® and magnet strips)

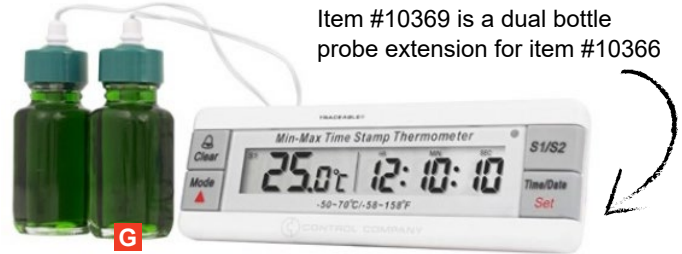

Traceable® Thermometers

- Reads the ambient room temperature as well as the external probe temperature using the in/out function
- Alarm programmable in 1° increments

Item #	Description	Probe Type	Dimensions (W x H x D)
14144	A Traceable® Refrigerator/Freezer Thermometer	5 mL Bottle Probe	2-3/4 x 4-1/4 x 3/4"
10367	B Traceable® Refrigerator/Freezer Thermometer	Ambient Probe	2-3/4 x 4-1/4 x 3/4"
10368	C Traceable® Refrigerator/Freezer Thermometer	10 mL Bottle Probe	2-3/4 x 4-1/4 x 3/4"
17751	D Traceable® Jumbo Refrigerator/Freezer Thermometer	10 mL Bottle Probe	3-7/8 x 4-3/8 x 7/8"
17752	Traceable® Jumbo Refrigerator/Freezer Thermometer	5 mL Bottle Probe	3-7/8 x 4-3/8 x 7/8"
17750	E Traceable® Jumbo Refrigerator/Freezer Thermometer	Ambient Probe	3-7/8 x 4-3/8 x 7/8"
14140	F Traceable® High Resolution Refrigerator/Freezer Plus™ Thermometer	10 mL Bottle Probe	3-1/4 x 2-1/5 x 5/8"
10366	G Traceable® Dual Thermometer	2 10 ml Probes	3-1/2 x 1-3/4 x 1"
10369	Traceable® Dual Bottle Probe Extension for #10366	2 Ambient Probes	3-1/2 x 1-3/4 x 1"



Traceable® High-Accuracy Refrigerator/Freezer Thermometer

- Displays the exact time and date when the minimum and maximum temperature occurred
- Displays the exact time and date alarm is triggered
- Alarm programmable in 0.1° increments

Traceable® Excursion-Trac® Datalogging Thermometer

- Datalogging thermometer with user-defined time intervals
- Stores up to 10 unique alarm events - alarm tracking stores each alarm event, the time and date of occurrence
- Rolling memory structure maintains the most recent 525,000 observations, clear after downloading to USB flash drive (unit can remain in use while downloading data)
- Allows recorded data (CSV file) to be transferred from thermometer to PC or Mac using a USB flash drive (not included). No software is needed for computer interface. Each thermometer has a unique ID allowing multiple units to be used in the same location
- Status indicators show low battery, memory full, USB data transfer and active alarm state

Traceable® Memory-Loc™ Datalogging Thermometer

- Can be used in 21 CFR 11 environments – data is locked and cannot be cleared or changed on unit
- Fixed one minute logging intervals, for up to 2 years
- Stores up to 10 unique alarms - alarm tracking stores each alarm event, the time and date of occurrence
- Allows recorded data (CSV file) to be transferred from thermometer to PC or Mac using a USB flash drive (not included). No software is needed for computer interface. Each thermometer has a unique ID allowing multiple units to be used in the same location
- Status indicators show low battery, memory full, USB data transfer and active alarm state

Item #	Description	Probe Type	Dimensions (W x H x D)
17988	A Traceable® High-Accuracy Refrigerator/Freezer Thermometer	10 mL Bottle Probe	2-3/4 x 4-1/4 x 3/4"
17989	B Traceable® High-Accuracy Refrigerator/Freezer Thermometer	10 mL Bottle Probes (2)	2-3/4 x 4-1/4 x 3/4"
17990	C Traceable® High-Accuracy Refrigerator/Freezer Thermometer	Ambient Probes (2)	2-3/4 x 4-1/4 x 3/4"
19197	D Traceable® Excursion-Trac® Datalogging Thermometer	10 mL Bottle Probe	2-3/4 x 4-1/4 x 3/4"
19198	E Traceable® Excursion-Trac® Datalogging Thermometer	10 mL Bottle Probes (2)	2-3/4 x 4-1/4 x 3/4"
19195	F Traceable® Memory-Loc™ Datalogging Thermometer	10 mL Bottle Probe	2-3/4 x 4-1/4 x 3/4"
19196	G Traceable® Memory-Loc™ Datalogging Thermometer	10 mL Bottle Probes (2)	2-3/4 x 4-1/4 x 3/4"

Traceable® Digital Humidity/Temperature Meter

- Display - Continuously and simultaneously displays relative humidity and temperature in °F or °C.
- Min/ Max Display - Minimum and maximum memories may be displayed or cleared at any time with the touch of a button.
- Temperature Range - Temperature range is 0° to 50°C (32° to 122°F) and with a resolution of 1° and maintains an accuracy of ±0.1°C/±0.1°F. Humidity range is from 25 to 95%, resolution is 1% RH, and accuracy is ±2% RH mid-range to ±4% RH elsewhere.
- Solid State Sensors - Fast-response solid-state sensors display changes in less than 30 seconds. Display is updated once per second.
- NIST Certified - Includes individually serial-numbered Traceable® Certificate.
- Recalibration is the customer's responsibility and annual recalibration is recommended.
- Power - Includes 2 AAA batteries



Item #	Dimensions (W x H x D)
14141	2-5/8 x 3-7/8 x 5/8"



Alarm Thermometer | 90711

- Use for precise monitoring
- Reads temperatures from -50° - 70° C (-58° - 158° F), with an accuracy of ±0.1°C
- Four unique alarm configurations: when temperature is higher than set point, lower than set point, outside of high and low set points, or inside of high and low set points
- Continuous alarm sounds and blinks red and green every minute for five minutes until the temperature returns to non-alarm condition or until alarm is turned off
- 1 meter micro cable allows refrigerator doors to close on it
- Jumbo display is readable from 3 meters away
- Calibration is accredited by A2LA and meets NIST standards
- Made of high-impact, chemical-resistant ABS plastic

Digital Clock/Timer

- Track Multiple Activities - Three distinctive alarms help eliminate confusion. Timer counts both up and down. The clock mode runs continuously.
- Use Anywhere - Built in clip, stand, magnet and hanging hole on back side.
- Wireless - One AAA battery included

Item #	Dimensions (W x H x D)
10461	3 x 2½ x ¾"



Storage Information
Labels can be found on
page 135



Refrigerator/Freezer Thermometer | 3010

- Temperature Range - From -40°F to 120°F, -40°C to 50°C
- Display - Non-toxic, mercury-free thermometer
- Dimensions - 1 1/16"W x 4 1/2"H x 3/8"D



TraceableLive® Wifi Datalogging Thermometer | 10364

- Wireless Temperature Monitoring and more—connect to existing WiFi
- Alerts: temperature alarm, connectivity interruption, low battery
- Cloud-based data interface—no local software required; web, Android, Apple IOS data visibility
- Continuous data transmission and monitoring using SSL encrypted SECURE connection
- Receive MOBILE PUSH / E-MAIL / TEXT notifications
- Unlimited scalability—use TraceableLIVE® in individual labs or an entire network of facilities

Item #	UPC
10364	063636103644

Fridge-Tag® Storage Temperature Monitor with USB | 194465

- Fridge-Tag 2L's direct display feature requires no software to quickly review 30 day's worth of data instantly.
- Monitors the temperature inside the unit to protect the integrity of temperature-sensitive drugs
- Dimensions - 5 1/4"W x 2 15/16"H x 9/16"D



Stainless Steel Refrigerator/Freezer & Dry Storage Thermometer

- Colour zones on dial indicate safe ranges and HACCP guidelines
- Reads temperatures from -30° - 30° C (20° - 80° F), with an accuracy of ±1°C
- Features attached hook for easy hanging or use base for free standing
- NSF certified

Item #	Measures
16087	2" diameter

Traceable® Long Probe Thermometer

- Reads temperatures from -50° – 300° C (-58° - 572° F), 0.1° resolution, accuracy of ±0.1°C
- Reading is updated every second
- Memory recalls previous min./max. readings
- Waterproof and shockproof - stainless steel probe is impervious to acids, bases, and solvents; can be inserted in a variety of solutions
- Includes Traceable® certificate to verify traceability standards
- Battery included (1.5V silver-oxide)



Item #	Dimensions (L x W x H)
10375	10-1/4 x 1-3/4 x 8" Long Probe

Undercounter Freestanding Refrigerator

- Units feature a digital microprocessor temperature controller allowing for the precise temperature management necessary for critical samples and supplies.
- A forced air directional refrigeration system provides superior temperature uniformity and recovery after door openings.
- Environmentally friendly, natural hydrocarbon (HC) refrigerants (not containing hydrofluorocarbons) vastly reduce global-warming potential (GWP) while meeting new EPA/SNAP mandates and UL, ASHRAE compliance guidelines.

Includes:

- Temperature controller
- Digital setting accuracy
- Precise temperature maintenance
- Monitoring and alarms
- High/low temperature alarm
- Sensor error alarm
- Alarm mute
- Remote contacts



Item #	Electrical	Volume	Dimensions (W x D x H)	Cycle	Door Type	No. of Shelves
REF303	115V, 60 Hz, 0.90A	71 L (2.5 cu. ft.)	17-3/4 x 19-1/2 x 28-7/8"	Defrost	1 Glass Swing	4 Adjustable
REF304	A 115V, 60 Hz, 0.90A	51 L (1.8 cu. ft.)	17-1/4 x 19-1/4 x 21-1/4"	Defrost	1 Glass Swing	2 Adjustable



Freestanding Refrigerators

- Designed to enhance pharmaceutical storage and display experience to the highest standards of quality and performance.
- Self contained Cassette® forced-air refrigeration employs R290 hydrocarbon Natural
- Refrigerant within a sealed capillary tube system.
- Cassette® refrigeration is bottom-mounted and removable from the front for ease of maintenance. Refrigeration may be exchanged or upgraded without mechanic. Designed to hold 36°F to 46°F (2.2°C to 7.7°C).
- Equipped with Energy Efficient Digital Controller featuring visual/audible product protection alarm.
- Technologically advanced ProcuTemp™ provides exterior product temperature display. Displays to a resolution of 0.1°.

Item #	Electrical	Volume	Dimensions (W x D x H)	Door Type	No. of Shelves
REF12C	B 115V/3.1 Amp/60 Hz	28 cu. ft	24 x 23-7/8 x 62"	1 Glass Swing	4
REF18C	C 115V/3.1 Amp/60 Hz	35 cu. ft	24 x 23-7/8 x 78"	1 Glass Swing	7
REF46H	D 115V/4.3 Amp/60 Hz	78 cu. ft	47-1/2 x 31 x 78"	2 Glass Swing	10

Stainless Steel Locking Refrigerator Storage Boxes

- Ideal solution for areas that cannot accommodate full-sized locking refrigerators self-locking nuts and bolts to refrigerator shelves
- Featured pre-drilled holes to use with security seals
- All locks (except padlocks) come keyed differently on a master key system; contact us for keyed alike options
- Select from styrene drawers, or acrylic (to view contents, noted below)
- Outside box measures: 5 $\frac{3}{4}$ "W x 4 $\frac{1}{4}$ "H x 11 $\frac{1}{4}$ "D
- Inside box measures: 5 $\frac{3}{16}$ "W x 3"H x 10 $\frac{9}{16}$ "D
- Made of 18-gauge stainless steel
- **Note:** Acrylic drawers cannot be used with security seals or dividers

Item #	Description
3725	A Key Lock
3726	B Slam Lock or Padlock
3735	C Acrylic drawer with key lock

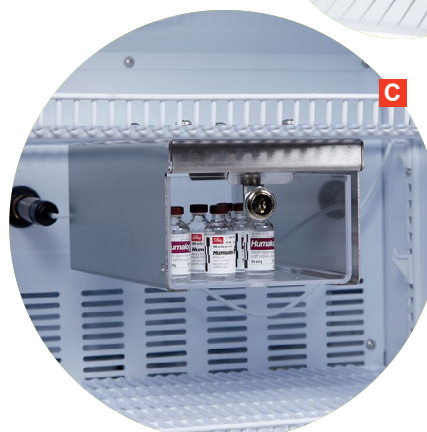

Deluxe Refrigerator Boxes

- Secure - Easily organize and store temperature-sensitive medication in these lockable, tamper-proof refrigerator boxes
- Durable - PETG construction means boxes have superior impact qualities for years of everyday use
- Prevents Rolling - Roll stop lip prevents contents from rolling beyond the edge of the box.

Item #	Description	Dimensions (W x H x D)
17844	D Deluxe Compact Refrigerator Box, KEDL	8-1/8 x 3-1/2 x 4-13/16"
17524	E Deluxe Refrigerator Box, Key Lock	15-3/16 x 3-1/2 x 7-5/8"
17526	F Deluxe Compact Refrigerator Box, Double Key Lock	8-1/8 x 3-1/2 x 41-3/16"

Rugged Refrigerator Boxes

- Secure - Easily organize and store temperature-sensitive medication in these lockable, tamper-proof refrigerator boxes
- Durable - Boxes are made of rugged polycarbonate material that provides extra durability for years of everyday use.
- Prevents Rolling - Roll stop lip prevents contents from rolling beyond the edge of the box.
- Maintain storage capacity - No tools required for assembly. Because there is no obtrusive mounting fixtures, the boxes take virtually no space away from the shelves above them
- Dimensions - 10³/₁₆"W x 3⁷/₈"H x 5¹/₄"D

Item #	Description
18907 A	Rugged Refrigerator Box, Key Lock
18908	Rugged Refrigerator Box, KEDL
18909 B	Rugged Refrigerator Box, Dial Combination
19166	Rugged Refrigerator Box, Key Lock, Amber
19167 C	Rugged Refrigerator Box, KEDL, Amber

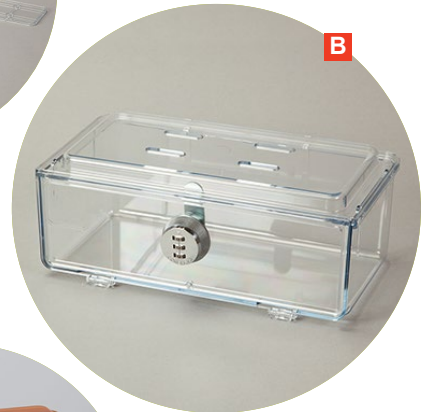

Locking Refrigerator Boxes, Tilting & Non-Tilting

- Secure - Acrylic locking refrigerator boxes organize and secure temperature-sensitive medications.
- Multiple Lock Styles - Available in two locking styles: Key Lock or Keyless Entry Digital Lock.
- Dimensions - 12³/₈"W x 4³/₈"H x 12³/₁₆"D

Item #	Description
18541 D	Tilting Refrigerator Box, Key Lock
18544	Non-Tilting Refrigerator Box, Key Lock

Locking Refrigerator Storage Boxes

- Ideal for use in facilities without access to locking refrigerators
- Ideal for controlling substances under single or double locks
- Lids can be affixed to refrigerator shelves (includes mounting brackets, nuts and bolts)
- Storage boxes function as a locked refrigerator drawer – once affixed to refrigerator shelves, boxes slide out from unlocked lid
- Tough, durable polyethylene construction
- Available in ● grey, ● light blue, or ● red – please specify colour when ordering

Item #	Description	Inside Dimensions (W x H x D)
3712 E	Single Lock	6-1/2 x 2 x 9-1/8"
3713	Single Lock	6-1/2 x 3 x 9-1/8"
3714 F	Single Lock	6-1/2 x 4-1/2 x 9-1/8"



Hinged Locking Refrigerator Boxes

- Ideal for use in facilities without access to full-size or locking refrigerators
- Self-locking nuts and bolts cannot be removed unless unit is open and unlocked – ensures safe and secure control over substances
- Available with single, double, or combination keyless locks
- Mounting accessories included



Item #	Size	Dimensions (L x W x H)	Lock
3746-01	A Compact	8-3/8 x 2-7/8 x 4-1/2"	Single Lock
3747-01	Compact	8-3/8 x 2-7/8 x 4-1/2"	Double Lock
3748-01	Small	12 x 4-1/2 x 6"	Single Lock
3749-01	B Small	12 x 4-1/2 x 6"	Double Lock
17843	C Small	12 x 4-1/2 x 6"	Keyless Entry Digital Lock

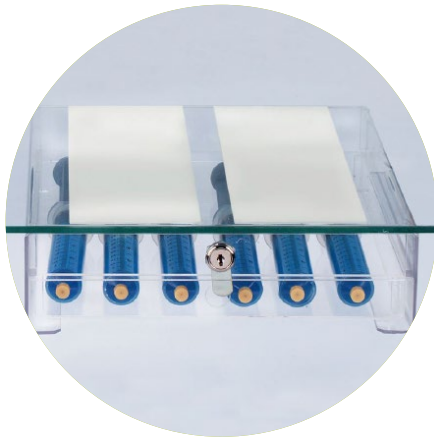

Two-Sided Tape for all Refrigerator Boxes

- Flexibility - Mount refrigerator boxes virtually anywhere. Double-sided tape works great on carts, countertops, in narcotic safes or anywhere a small box may be needed.

Item #	Dimensions (W x L)
9934	4 x 11"

Refrigerate Zippit Bag

- Preprinted Message - Alert users to temperature sensitive contents.
- Thickness - 2.5-mil
- Closure - Reclosable zipper

Item #	Size	Qty
7629-10	5 x 8"	100
18239	3 x 5"	100
19547	12 x 15"	100



MonitorMark™ Product Exposure Indicators

- Ideal for use when transporting temperature-sensitive items
- Tags monitor temperature by changing colour to visually depict if acceptable temperature limit has been exceeded
- Records time exposed to unacceptable temperatures
- If an item can tolerate limited exposure to elevated temperatures, the results on the tags will help determine whether to accept or reject the item
- When the maximum temperature of the tag is exceeded, a blue colour appears in the window furthest to the left
- Colour change is irreversible
- Attaches with an adhesive back to most clean, dry surfaces
- Measures : 3 7/8 x 3/4"
- 10 per package

Item #	Temperature Range	Exposure Time
8201-01	5°C (41°F) and above	48 Hours
8205-01	10°C (50°F) and above	48 Hours
8207-01	10°C (50°F) and above	1 Week
8208-01	31°C (88°F) and above	1 Week



Insulated Boxes

- Disposable, lightweight cooler to transport and ship temperature-sensitive items
- Leak-resistant gusseted liner made from FDA-approved materials
- Liner's adhesive lip tape seals the contents for maximum protection
- Boxes are shipped flat; each has instructions for assembly

Item #	Dimensions (W x H x D)	Qty
17878	8 x 8 x 8"	5

Insulated Transport Boxes

- Cost Effective - Keep medications at a stable temperature during transport.
- Protects Drug Integrity - 1 1/2" thick insulated walls are ideal for transporting 24 to 48-hour shipments.

Item #	Dimensions (W x H x D)	Qty
19808	11 x 10 x 9	1
19807	15-1/2 x 12 x 15-1/2	1



























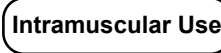



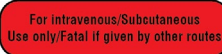

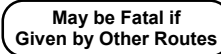
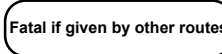









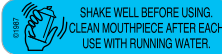

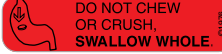

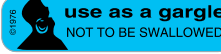

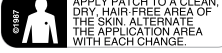

LABELS

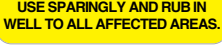
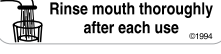
View items online for quantity and packaging details

Route of Administration Labels

 1-11G	 1-14G	 1-18G	 1-25G	 LPH-107
 1-26G	 2520	 1-51G	 1-52G	 AHSPT036
 1-72G	 1-78G	 1-393	 2155	 AHSPT036
 LPH-4	 LPH-5	 LPH-12	 LPH-13	 AHSPT040
 AHSPT032	 LPH-68	 LPH-82	 LPH-173	 LPH-19

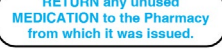
Administration/Instruction Labels

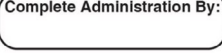
 1-10G	 1-40G	 1-49G	 AHSPT031
 P-30	 1-334	 2522	 1-339
 1-57G	 1-58G	 1-75G	 1-316
 1-328	 P-10	 1-98G	 1-330
 1-358	 1-389	 1-669	 2287
 LPH-1	 LPH-72	 LPH-78	 LPH-128
 LPH-138	 AHSPT017	 AHSPT025	 LPH-24
 CL-263			

Dosing Frequency Labels



1-344



1-348



1-375



1-345



1-349



1-436



1-795



1-350



LPH-218



1-796



1-351

Labels

Dietary Information Labels



1-326



1-354



1-690



P-10

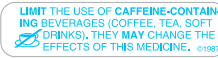

1-333



1-603



1-47G



10X



1-338



5X



1-66G



4X

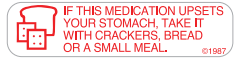

1-353

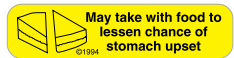

1-671



1-74G

Expiration & Discard Labels

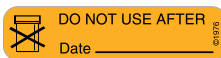

1-28G



2115



LPH-8



LPH-91

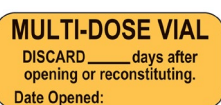

18326

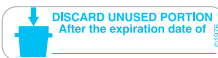

1-35G



1-370

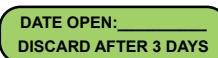

LPH-217



LPH-95



18225



1-320

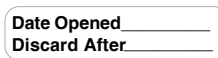

P-19



P-26



LPH-169

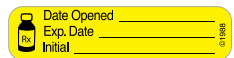

1-369



P-21



2764

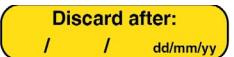

AHSPT041

Warning Labels



1-16G



1-19G



1-60G



1-63G



1-70G



15W

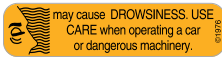

1-76G



1-83G



1-95G



8X



2611

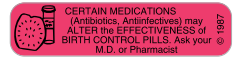

1-360



1-332



1-601

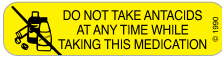

1-604



1-673

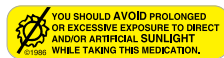

11X

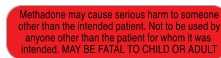

P-2

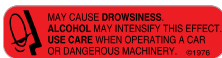

1X



P-60



2722



1-88G

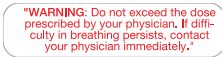

P-1



2290

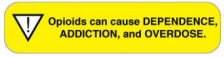

P-32



LPH-26



LPH-6



LPH-14



2911

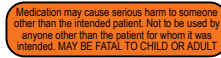

P-34



2766



LPH-17



CL-1526



LPH-37

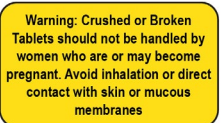

CL-1182

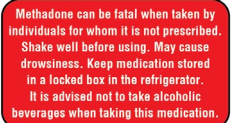

LPH-105



13-2



17519

Our standard labels measure 1-9/16" x 3/8" (40 x 9.5 mm), 2 rolls of 500 per box. Conveniently packaged in a user-friendly dispensing blister, compatible for use with PharmaSystems' label dispensers. For more information on sizes and quantities, please view our website for more details.



Caution Labels

-CAUTION-
Antineoplastic Material
Handle Properly

-CAUTION-
Antineoplastic Material
Handle Properly

POISON

CYTOTOXIC AGENT
DISPOSE OF PROPERLY



BIO-HAZARD

CYTOTOXIC

Cytotoxic
Cytotoxique

LPH-85

LPH-90

Cytotoxic
Cytotoxique

CYTOXIC MATERIAL
HANDLE PROPERLY

FOR INVESTIGATIONAL
USE ONLY

CHEMOTHERAPY DRUG
TOXIC
DISPOSE OF AS BIOHAZARD

LPH-174

2373

2374

2372

CAUTION: CHEMOTHERAPY
Dispose of Properly

CHEMOTHERAPY
DISPOSE OF PROPERLY

HD CAUTION: HAZARDOUS DRUG
OBSERVE SPECIAL HANDLING,
ADMINISTRATION AND DISPOSAL
REQUIREMENTS

WARNING: Paralyzing Agent
Causes Respiratory Arrest

2291

18595

LPH-77

HANDLE WITH CAUTION
IF PREGNANT, PLAN ON BECOMING
PREGNANT OR IF BREASTFEEDING

NARCOTIC

NARCOTIC

CAUTION: ANTI-NEOPLASTIC MATERIAL
HANDLE PROPERLY.

LPH-84

LPH-106

LPH-210

AVOID
EXTRAVASATION

METHADONE

HAZARDOUS DRUG
HANDLE PROPERLY

HAZARDOUS DRUG
Personal Protective Equipment Required
Dispose of as Hazardous Waste

2290

LPH-123

LPH-125

LPH-126

HD CAUTION: HAZARDOUS DRUG
OBSERVE SPECIAL HANDLING
ADMINISTRATION AND DISPOSAL
REQUIREMENTS
HIGH ALERT

Hazardous Drug
Low Risk



CL-664

LPH-176

LPH-227

PCT-8



Follow PPE Guide | **HAZARDOUS Medication**

AHSPT039

AHSPT04

AHSPT05

AHSPT047

HAZARD: Reproductive Risk
IF Potential to Conceive, Pregnant, or
Breastfeeding **FOLLOW PPE Guide**

Follow PPE Guide | **HAZARDOUS Medication**

Follow PPE Guide | **KNOWN Hazard Medication**

Follow PPE Guide | **POTENTIAL Hazardous Medication**

AHSPT048

AHSPT049

AHSPT050

AHSPT051

HAZ. Med.

CAUTION
Concentrated Potassium
Fatal if Injected undiluted
DILUTE BEFORE USE

CAUTION
IV contains Potassium
FOR CENTRAL LINE ONLY

CAUTION
IV contains Potassium

AHSPT055

AHSPT06

AHSPT023

AHSPT07

CAUTION
Concentrated Potassium
Fatal if injected undiluted
DILUTE BEFORE USE

-CAUTION-
MUST BE DILUTED
CONCENTRATED POTASSIUM

CAUTION
Concentrated Sodium
Fatal If Injected undiluted
DILUTE BEFORE USE

CAUTION
Hypertonic Sodium Chloride

LPH-232

LPH-76

AHSPT08

AHSPT09

CAUTION
HIGH Concentration

CAUTION
High Potency Medication
Confirm Dose

CAUTION
Concentrated Electrolyte

AHSPT037

AHSPT010

AHSPT024

Labels

Allergy Labels



2889

CONTAINS LATEX

AHSPT034

CHECK FOR ALLERGIES

LPH-208

ALLERGY

LPH-215

Storage Information Labels



1-15G



1-324



P-5



P-12



P-13



2281



2280



AHSPT012



AHSPT026



CL-41



AHSPT029



CL-241



LPH-239



2960



AHSPT028

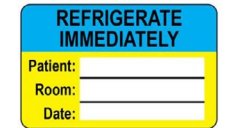

CL-713

Communication Labels



PP-1



PP-2

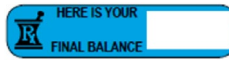

LPH-163



1-56G



1-584



LPH-36



1-343



2286

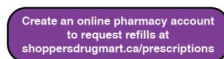

P-90



LPH-79



AHSPT011



AHSPT042

Dosing Information Labels

 **THIS BOTTLE IS NOT FULL**
BUT CONTAINS EXACT AMOUNT
PRESCRIBED BY THE PHYSICIAN
©1976

1-38G

 **NOTE** **DOSAGE**
STRENGTH
©1976

1-53G

 **AUTOMATIC**
STOP ORDER DRUG

1-54G

 **CAUTION**
DOSAGE STRENGTH DIFFERENT FROM
ORDER. USE APPROPRIATE AMOUNT.

1-55G

 **RETURN TO**
PHARMACY

1-56G

PHARMACY ALTERED

17729

Package Has Been
Altered By Pharmacy

LPH-171

THIS BAG WAS
ALTERED BY PHARMACY

LPH-197

Altered by Pharmacy

AHSPT054

Pharmacy Removed:

LPH-230

Pharmacy Added:

LPH-231

NOTE: MEDICATION
BROKEN IN HALF

5-376

NOTE: MEDICATION BROKEN
IN HALF

2285

SINGLE USE ONLY

2054

 **STRENGTH OF TAB/CAP**
DIFFERENT FROM THAT OF
DOSE ORDERED. GIVE
APPROPRIATE AMOUNT.

1-356

USE FIRST

2306

SHORT DATED
USE FIRST

LPH-172

USE FIRST

LPH-75

USE LAST

2307

MUST BE DILUTED

17864

 **A GENERIC EQUIVALENT**
DRUG has been dispensed of
the same **QUALITY** and at a
LOWER PRICE

1-301

 **GENERIC**
SUBSTITUTION MADE

1-305

 **A GENERIC DRUG**
HAS BEEN DISPENSED
AT A **LOWER PRICE**

1-306

 **GENERIC EQUIVALENT**
DISPENSED AS REQUIRED
BY **INSURANCE CARRIER**

1-368

 **AN INTERCHANGEABLE PHARMACEUTICAL**
PRODUCT HAS BEEN SUPPLIED.
Colour, size or shape may appear different.

P-11

 **THIS IS THE SAME MEDICATION**
YOU HAVE BEEN GETTING.
COLOR, SIZE OR SHAPE MAY
APPEAR DIFFERENT.

1-61G

MEDICATION IN VIAL

LPH-97

ATTENTION:
MEDICATION IN COMPANION
STRIP, VIAL, BOTTLE OR CARD

LPH-153

DOSE IN 2 PORTIONS

AHSPT033

Please half tablets. Medication
Stable for 48h only when halved.

LPH-164

MEDICATION DISCONTINUED
REMOVE FROM PACKAGE

LPH-187

LONG ACTING
NARCOTIC

LPH-190

LONG ACTING

AHSPT01

SHORT ACTING

AHSPT03

SINGLE-DOSE VIAL

AHSPT014

START
HERE

AHSPT015

Labels

Nursing Labels

NURSING

TP1

MEDICINE

TP2

RECREATION

TP3

ACTIVATION

TP20

DAY PROGRAM

LPH-166

REHABILITATION

TP24

PASTORAL CARE

TP6

Altered by Nursing
Check MAR

LPH-18

REFER TO PATIENT'S
eMAR FOR DOSE

CL-541

REASSESS

LPH-181

DIRECTIONS CHANGED
REFER TO MAR SHEET

LPH-119

DIRECTIONS CHANGED
REFER TO MAR

LPH-124

CHECK MAR

LPH-130

CHECK PULSE
AND RECORD

LPH-29

 **One Pen, One Patient**
Prime Every Time

AHSPT044

REMOVE DISCONTINUED MEDICATIONS
REFER TO MAR SHEET

LPH-11

TARGETED

LPH-30

PATIENT
SPECIFIC

LPH-32

PLEASE RECONCILE THIS
PATIENT'S HOME MEDICATION LIST

LPH-69

Refill Information Labels



1-13G

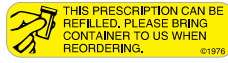

1-20G



1-21G



1-22G



1-27G



1-30G

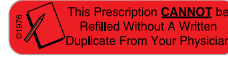

1-41G

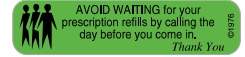

1-50G



2215

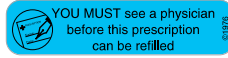

1-89G



1-92G

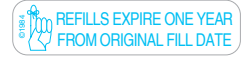

1-97G

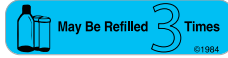

1-312



1-314

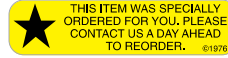

1-65G

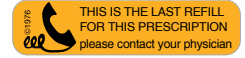

1-77G



1-44G



CL-534

IV Administration Labels



2410



LPH-182



17523



17573



17574



LPH-15



AHSPT027



LPH-211

Error Prevention Labels



LPH-100



AHSPT038



AHSPT0BAX



2308



8350



2155



17520



8351



2089



18251



2968



2090



FP-8353



8352



18253



8353



8354

French Labels



FG-10



FG-11

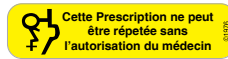

FG-13



FG-15



FG-22



FG-27



FG-28

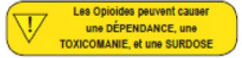

FG-32



FG-40

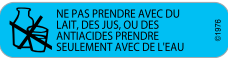

FG-47



FG-49

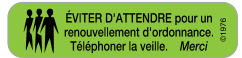

FG-50

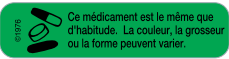

FG-61



FG-77



F-324

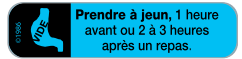

FW-3

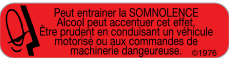

FX-1



FX-10



FX-11



FX-12



FX-2

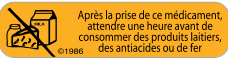

FX-4



FX-5



FX-8



LPH-101



LPH-108



LPH-149



LPH-205



LPH-191

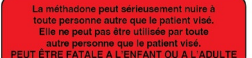

FP-2



FP-8353



CL-5

Labels

Drug Labels



LPH-25



LPH-34



LPH-66



LPH-74

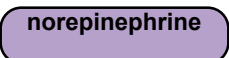

LPH-118



LPH-87

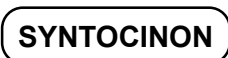

LPH-92



2154

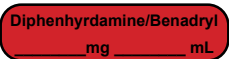

LPH-136

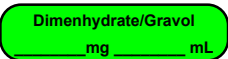

LPH-160

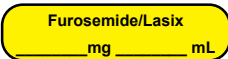

LPH-183



LPH-201



LPH-203

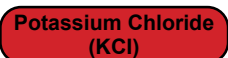

LPH-206



LPH-219



LPH-220



LPH-222



17838



2311



17790



17944



2868



17792



CL-1236

Anesthesia & Critical Care Labels

Nitroglycerine
mg/mL

B1

Atropine
mg/mL

B5

Propranolol
mg/mL

B9

Rocuronium
mg/mL

B17

Neostigmine
mg/mL

B22

Naloxone
mg/mL

B28

Sufentanil
mcg/mL

B36

EPINEPHRINE
mg/mL

B44

Ropivacaine
mg/mL

LPH-93

Diazepam
mg/mL

B2

Glycopyrrolate
mg/mL

B6

Hydromorphone
mg/mL

B12

Pancuronium
mg/mL

B18

Fentanyl
mcg/mL

B25

Ephedrine
mg/mL

B31

VERSED®/Midazolam
mg/ mL

B39

Cisatracurium
mg/mL

B45

ROPIVACAINE

LPH-94

Droperidol
mg/mL

B3

Heparin
units/mL

B7

Mivacurium
mg/mL

B14

Succinylcholine
mg/mL

B19

Meperidine
mg/mL

B26

Phenylephrine
mg/mL

B32

Oxytocin
units/mL

B40

Remifentanil
mcg/mL

B46

HYDROMORPHONE

CL-1474

Lidocaine
mg/mL

B4

Thiopental
mg/mL

B8

Atracurium
mg/mL

B16

Edrophonium
mg/mL

B21

Morphine
mg/mL

B27

Vecuronium
mg/mL

B35

Ketamine
mg/mL

B41

Ropivacaine
mg/mL

LPH-189

Haloperidol
mg/mL

LPH-59

Pre-printed Flag Labels, High Alert Double Check | 17437

- Convenient - Preprinted messages solve small product labeling needs and help prevent medication errors.
- Error Prevention - Flag receipt can either fold over to create an easy-to-read, double-sided label or the receipt can be removed at the perforation and applied to charts, records and packaging for traceability and accountability.
- Stays Put - Adhesive back portion wraps around the container; aggressive adhesive ensures label will remain on the container.
- Maintain Visibility - Clear middle on labels will not interfere with markings or graduations.
- Quantity - 2,000 labels per package
- Dimensions - 3 $\frac{3}{8}$ "W x 3 $\frac{1}{4}$ "H



New label tool!

Maximize Efficiency Using Our Free Online Label Printing Solution

Laser print each side of the label with multiple lines of matching text and barcodes or print separate information on each side to provide complete patient and drug identification information. Our easy-to-use labeling solution saves label set up and design time and allows for horizontal or vertical print depending on application and label placement.

Start creating your label today!

Hospital Information Labels



PCT-1
21/4 x 31/4"
500/Roll



PCT-3
1 x 3/4"
1000/Roll

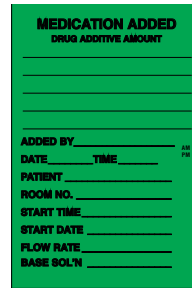

21-2
2 x 3"
500/Roll (2 Rolls)

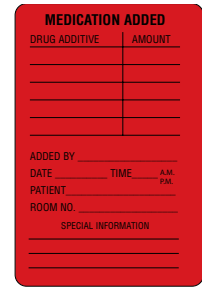

MAR1
2 x 3"
1000/Roll



CC2
6 x 11/16"
500/Roll

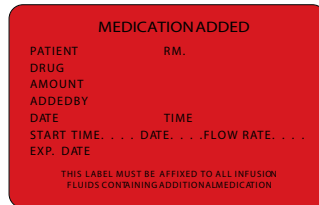

MAR3
23/4 x 13/4"
1000/Roll

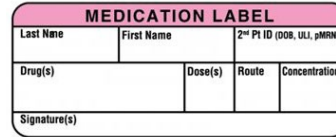

MAR8
21/2 x 1"
1000/Roll

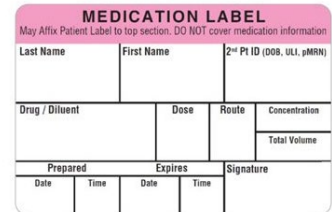

MAR7
3 x 2"
1000/Roll

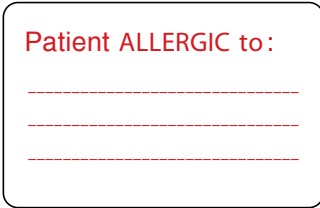

23-1
23/4 x 13/4
1000/Roll

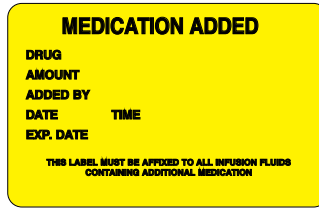

23-2
23/4 x 13/4"
1000/Roll

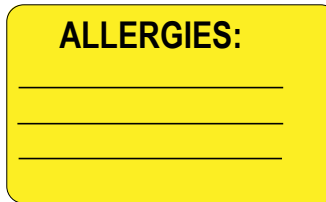

17614
21/2 x 11/2"
500/Roll (2 Rolls)

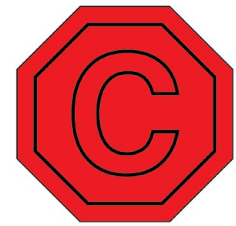

PCT-8
3/4" Hexagon
1000/Roll

Labels

Veterinary Labels

Labels

Acepromazine
mg/mL

VET26

Alfaxalone
10 mg/mL

VET23

Ampicillin
100 mg/mL

VET30

Atipamazole
5 mg/mL

VET25

Atropine
0.5 mg/mL

VET13

BUPIVACAINE
5 mg/mL

VET48

Bupivacaine
5 mg/mL

VET20

Buprenorphin
0.3 mg/mL

VET35

Buprenorphine
0.5 mg/mL

VET47

Butorphanol
10 mg/mL

VET40

Carprofen
50 mg/mL

VET42

Cefazolin
100 mg/mL

VET45

Dexmedetomidine
500 mcg/mL

VET27

Diazepam
5 mg/mL

VET11

Dopamine
1600 mcg/mL

VET38

Dopamine
800 mcg/mL

VET39

Enrofloxacin
50 mg/mL

VET31

Enrofloxacin
50 mg/mL

VET51

Epinephrine
1:1000

VET28

Famotidine
10 mg/mL

VET32

Fentanyl
50 mcg/mL

VET15

FOR VETERINARY USE ONLY

P-18

Furosemide
50 mg/mL

VET21

Glycopyrrolate
0.2 mg/mL

VET14

Hydromorphone
10 mg/mL

VET33

Hydromorphone
2 mg/mL

VET34

Ketamine
100 mg/mL

VET24

Lidocaine
20 mg/mL

VET19

Maropitant
10 mg/mL

VET44

Meloxicam
5 mg/mL

VET12

Meloxicam
20 mg/mL

VET46

Metronidazole
5 mg/mL

VET29

Methadone
mg/mL

VET36

Metoclopramide
5 mg/mL

VET43

Midazolam
5 mg/mL

VET10

Neostigmine
2.5 mg/mL

VET18

Norepinephrine
mcg/mL

VET37

Ondansetron
2 mg/mL

VET49

Pantoprazole
4 mg/mL

VET50

Propofol
10 mg/mL

VET22

Prepaid

VET52

Remifentanil
mg/mL

VET16

Rocuronium
10 mg/mL

VET17

Robenacoxib
20 mg/mL

VET41

Blank Labels

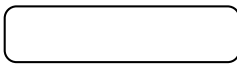

A10



2546



2204



2558



A11



2550



A13



2548



2211



2553



2214



2555



A12



2552

Weekday Auxiliary Labels

MON.

P-70

MON

17916

TUES.

P-71

TUE

17917

WED.

P-72

WED

17918

THUR.

P-73

THU

17919

FRI.

P-74

FRI

17920

SAT.

P-75

SAT

17921

SUN.

P-76

SUN

17922

English Monthly Labels

JAN

P-41

FEB

P-42

MAR

P-43

APR

P-44

MAY

P-45

JUN

P-46

JUL

P-47

AUG

P-48

SEP

P-49

OCT

P-50

NOV

P-51

DEC

P-52

French Monthly Labels

JAN

P-41

FEV

P-52

MAR

P-43

AVR

P-54

MAI

P-55

JUIN

P-56

JUIL

P-57

AOU

P-58

SEP

P-49

OCT

P-50

NOV

P-51

DEC

P-52

English monthly label package P-100

Includes 1 label sheet of each month (108 labels per sheet)

French monthly label package | P-101

Includes 1 label sheet of each month (108 labels per sheet)

Label Dispensers (empty)

- Rugged construction and high quality design ensure years of trouble free use
- Superior design permits one hand label dispensing
- Dispensers can be quickly loaded and easily cleaned
- Holds any of the PharmaSystems® standard size warning labels, shown on previous pages in this section
- Additional, pre-loaded options below



Item #	Description
BK-10	Label Dispenser for 10 Rolls
BK-30	Label Dispenser for 30 Rolls

Label Dispenser with Warning Labels (pre-loaded)

- 20 rolls of 500 auxiliary labels preloaded into a 30 roll label dispenser (includes BK-30 model)
- Select from English or French sets

Item #	Description
BK-50	English Warning Label System
FW-1730	French Warning Label System

BK-50

 1X	 2X	 3W	 4X	 5X
 8X	 10X	 11X	 15W	 1-10G
 1-11G	 1-49G	 1-70G	 1-77G	 1-332
 1-360	 1-669	 1-690	 P-1	 P-12

FW-1730

 FG-15	 FW-15	 FG-50	 FX-1	 FX-10
 FX-11	 FX-12	 FX-2	 FX-4	 FX-5
 FG-61	 FX-8	 FG-27	 FG-10	 F-690
 FG-77	 FG-28	 FG-13	 FG-49	 F-324

Stainless Steel Label Dispensers

- Labels in blister packed rolls fit without dividers, but dividers can be inserted to accommodate labels on plain rolls
- The front label guides accommodate up to 3/4" W labels

Item #	Description
2504-01	10 Roll Label Dispenser 7-1/8"W x 4-1/8"H x 4-1/4"D
2506-01	30 Roll Label Dispenser 19-5/16"W x 4-1/8"H x 4"D

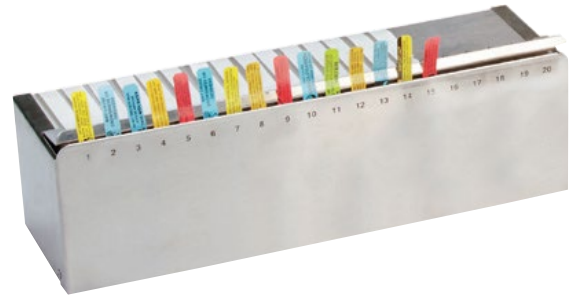

Stack & Connect Label Dispensers

- Clear plastic dispensers interlock to stack and connect – create your own customized label dispenser

10 roll dispenser (item # 12721):

- Includes 9 removable dividers, when used accommodate labels measuring 5/8" wide
- Accommodates blister-packed labels as well as labels on a roll
- Accommodates 500 and 1000 roll labels/packs

20 roll dispenser (item # 12998):

- Does not include dividers
- Accommodates blister-packed labels and labels on a roll
- Only 500 roll labels/packs will work

Mounting Brackets:

- Allows dispensers to be mounted to counters or cabinets
- Pre-drilled holes in white plastic brackets
- Mounting hardware and two-sided tape included

Item #	Description (W" x H" x D")
12721	A 10 Roll Label Dispenser (8-1/4" x 5" x 4-3/4")
12998	B 20 Roll Label Dispenser (15-3/4" x 4-3/8" x 4-3/4")
17027	C Mounting Bracket for #12721 10 Roll Dispenser
17028	D Mounting Bracket for #12998 20 Roll Dispenser

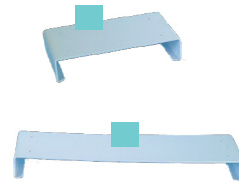

Labels



A

PATIENT PRIVACY LABEL • ÉTIQUETTES
DE CONFIDENTIALITÉ DES PATIENTS •
PATIENT PRIVACY LABEL • ÉTIQUETTES
DE CONFIDENTIALITÉ DES PATIENTS •
PATIENT PRIVACY LABEL • ÉTIQUETTES
DE CONFIDENTIALITÉ DES PATIENTS •
PATIENT PRIVACY LABEL • ÉTIQUETTES
DE CONFIDENTIALITÉ DES PATIENTS •
B

Patient Privacy Label

- Quick and affordable way to protect sensitive patient information and meet HIPAA standards
- Wrap over labels on prescription vials, punch cards, syringes and IV bags. Patient information is then secure
- Tamper-resistant slits cause the label to self-destruct upon attempted removal
- No need to scrape patient labels or invest in expensive shredding or incineration equipment or services
- Opaque blue label
- Use in pharmacies, hospitals, long and short term care facilities, mental health facilities, clinics and physicians offices
- Dimensions: 3"W x 1-7/8"H (76mm x 48mm)
- Two rolls of 500; 1,000 labels total

Item #	Description
7038	A English Patient Privacy Label
7039	B Bilingual Patient Privacy Label

Acrylic Label Dispenser with Dividers | 12722

- Customizable Storage: Includes 6 removable dividers (3-3/4") so you can organize multiple label rolls and adjust spacing to fit your needs
- Clear Acrylic Design: Transparent construction lets you quickly see labels, sizes and colours at a glance
- Keeps Labels Neat & Accessible: Prevents rolls from unraveling, tangling, or getting misplaced
- Streamlines Workflow: Speeds up labeling with quick one-hand access
- Professional Display Look: Clean, modern design elevates any workspace or counter
- Dimensions: 34.5 x 9 x 18 cm



Label Adhesive Remover, 32 oz. | 7055-10

- Easily removes the sticky residue that builds up on surfaces that have labels and tape applied and removed on a regular basis
- This citrus based adhesive remover contains no hazardous solvents or toxic fumes
- Bio-degradable and non-flammable
- Comes in a clear, unbreakable plastic squeeze bottle

Labeling Tape

- Size: 1 3/4" x 1/2"
- Qty: 6 rolls; 500" or approximately 285 labels per roll
- Rolls are packaged in clear, stackable containers with click-to-close design
- Perforations improve ease of use and help eliminate waste

2578

- Size: 1 3/4" x 1"
- 3 rolls; 500" or approximately 285 labels per roll



Dt. ____ Tm. ____ : ____ Init. ____

2540

ALLERGIC:

2578

ATRAcurium ____ mg/mL
Date ____ Time ____ : ____ Init. ____

2531

Atropine ____ mg/mL
Date ____ Time ____ : ____ Init. ____

2526

Bupivacaine ____ mcg/mL
Date ____ Time ____ : ____ Init. ____

2523

Cefazolin ____ mg/mL
Date ____ Time ____ : ____ Init. ____

2528

DEXAMETHASONE
Strength ____ mg/mL
Dt. ____ Tm. ____ : ____ Init. ____

2570

2560

Dopamine ____ mg/mL
Date ____ Time ____ : ____ Init. ____

2514

Ephedrine ____ mg/mL
Date ____ Time ____ : ____ Init. ____

2515

Epinephrine
____ mg/mL

2517

FENTANYL
Strength ____ mg/mL
Dt. ____ Tm. ____ : ____ Init. ____

2563

Glycopyrrolate ____ mg/mL
Date ____ Time ____ : ____ Init. ____

2527

Heparin ____ %
Date ____ Time ____ : ____ Init. ____

2525

Insulin 100 units/mL
Prep Date ____ Exp. Date ____
Initial ____ Exp. Time ____

2519

KETAMINE
Strength ____ mg/mL
Dt. ____ Tm. ____ : ____ Init. ____

2565

Lidocaine ____ mg/mL
Date ____ Time ____ : ____ Init. ____

2542

MIDAZOLAM
Strength ____ mg/mL
Dt. ____ Tm. ____ : ____ Init. ____

2561

MILRINONE ____ mg/mL
Date ____ Time ____ : ____ Init. ____

2510

MORPHINE
Strength ____ mg/mL
Dt. ____ Tm. ____ : ____ Init. ____

2562

NEOSTIGMINE
Strength ____ mg/mL
Dt. ____ Tm. ____ : ____ Init. ____

2571

Nitroglycerin ____ mg/mL
Date ____ Time ____ : ____ Init. ____

2518

Norepinephrine ____ mg/mL
Date ____ Time ____ : ____ Init. ____

2513

Oxytocin ____ mg/mL
Date ____ Time ____ : ____ Init. ____

2529

Phenylephrine ____ mg/mL
Date ____ Time ____ : ____ Init. ____

2535

Protamine Sulfate ____ %
Date ____ Time ____ : ____ Init. ____

2530

Remifentanil ____ mcg/mL
Date ____ Time ____ : ____ Init. ____

2511

ROcuronium ____ mg/mL
Date ____ Time ____ : ____ Init. ____

2538

Ropivacaine ____ mcg/mL
Date ____ Time ____ : ____ Init. ____

2534

SUCCINYLCHOLINE
Strength ____ mg/mL
Dt. ____ Tm. ____ : ____ Init. ____

2567

Sufentanil ____ mg/mL
Date ____ Time ____ : ____ Init. ____

2512

TRANEXAMIC ACID ____ mg/mL
Date ____ Time ____ : ____ Init. ____

2544

VASOPRESSIN ____ mg/mL
Date ____ Time ____ : ____ Init. ____

2543

PHARMASYSTEMS CUSTOM LABELS

SELECT LABEL SIZE & QUANTITY

LABEL ITEM NO.

QTY:

BOX(ES)

SELECT BACKGROUND COLOUR

- BLACK**
- WHITE**
- RED**
- NAVY BLUE**
- SKY BLUE**
- YELLOW**
- GREEN**
- ORANGE**
- PURPLE**

- FLUORESCENT RED**
- FLUORESCENT ORANGE**
- FLUORESCENT YELLOW**
- FLUORESCENT GREEN**
- FLUORESCENT PINK**

Please note: Only black text is available with fluorescent colours

SELECT TEXT COLOUR

- BLACK**
- WHITE**
- RED**
- NAVY BLUE**
- SKY BLUE**
- YELLOW**
- GREEN**
- ORANGE**
- PURPLE**

INPUT LABEL INFORMATION (PLEASE PRINT CLEARLY)

ADD A SYMBOL (OPTIONAL)

TO INCLUDE A COMPANY LOGO OR CUSTOM SYMBOL, PLEASE SUPPLY A VECTOR FILE (AI, EPS, PDF, SVG).

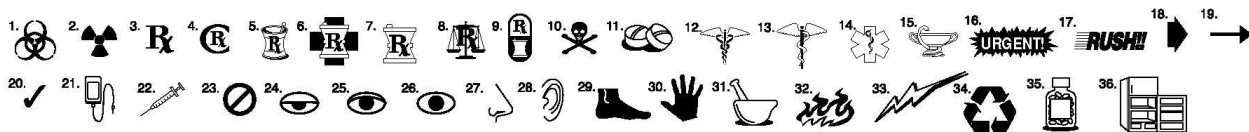

SYMBOL NO.:

PHARMACY NAME:		CONTACT NAME:	
ADDRESS:		PHONE:	
CITY:		FAX:	
PROVINCE:	POSTAL CODE:	EMAIL:	
DATE:	WHOLESALER:	ACCOUNT NO.:	



Please email or fax the completed order form to us. Kindly only return this page. Please note: we'll send a label proof to the email provided for approval. Labels will be ordered only after approval is confirmed.

PharmaSystems Inc.
 pharmasystems.com
 orders@pharmasystems.com
 fax: 1.888.475.7155

PharmaSystems®

LABELS ARE ACTUAL SIZE

CUSTOM LABEL SIZES

SELECT YOUR SIZE

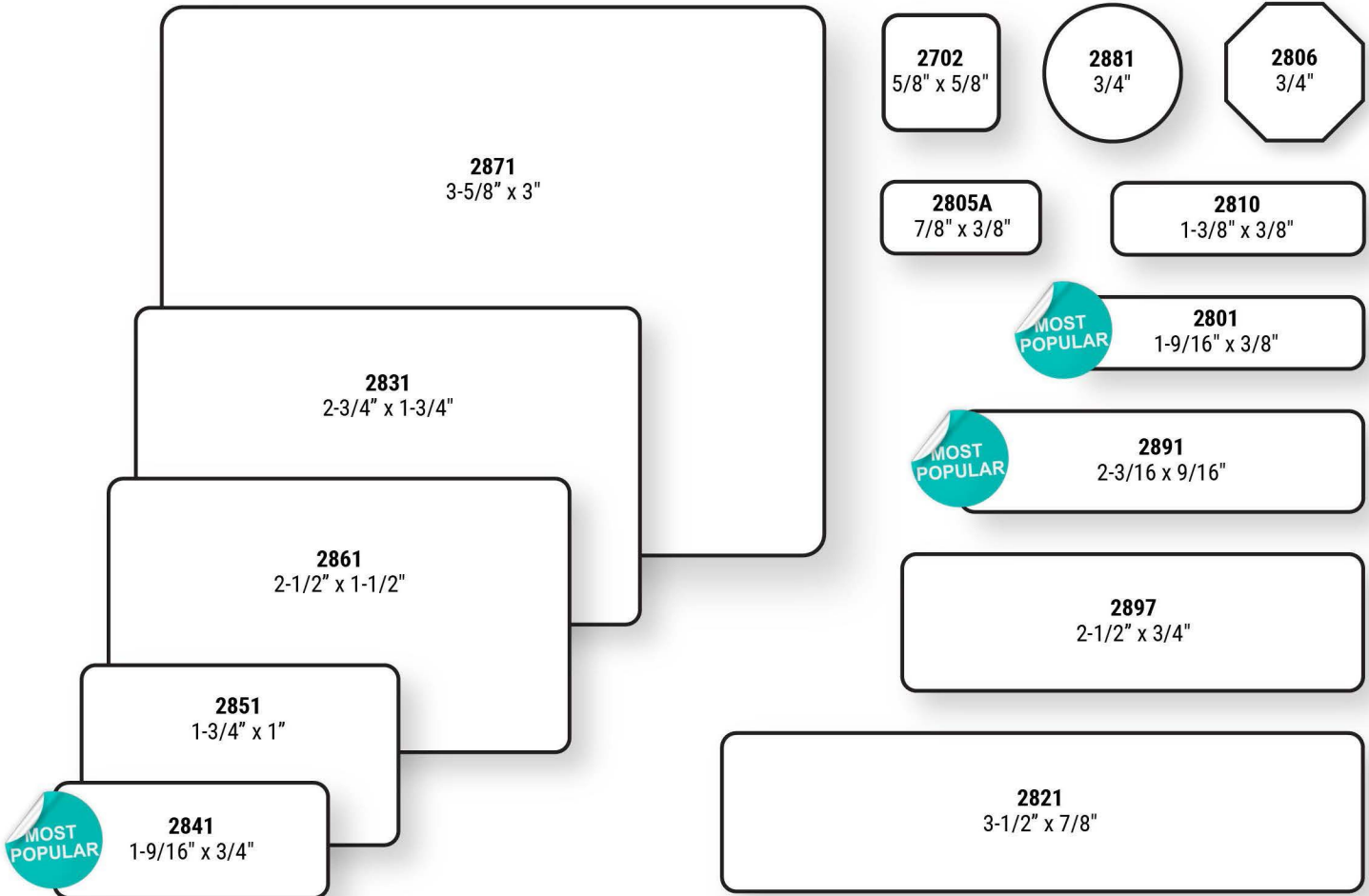

Item NO.	Dimensions (W x H)	Qty	MOQ
2871	3-5/8" x 3"	1,000	2,000
2831	2-3/4" x 1-3/4"	1,000	1,000
2861	2-1/2" x 1-1/2"	1,000	1,000
2851	1-3/4" x 1"	1,000	1,000
2841	1-9/16" x 3/8"	1,000	6,000
2702	5/8" x 5/8"	1,000	1,000
2881	3/4"	1,000	1,000

Item NO.	Dimensions (W x H)	Qty	MOQ
2806	3/4"	1,000	1,000
2805A	7/8" x 3/8"	1,000	1,000
2810	1-3/8" x 3/8"	1,000	1,000
2801	1-9/16" x 3/8"	1,000	1,000
2891	2-3/16" x 9/16"	1,000	1,000
2897	2-1/2" x 3/4"	1,000	1,000
2821	3-1/2" x 7/8"	1,000	1,000

Item NO.	Description	Roll Capacity
12721	Stack & Connect Label Dispenser	10 Rolls
12998	Stack & Connect Label Dispenser	20 Rolls
2506-01	Drop & Load Label Dispenser	30 Rolls



PharmaSystems Inc.

pharmasystems.com

orders@pharmasystems.com

fax: 1.888.475.7155

ChemoSafety™ Sharps Disposal Containers

- Designed for sharps disposal as well as other types of chemotherapy waste, including IV bags, tubing, and syringes
- Container features snap-on lid with locking rotor that locks for final disposal
- Sealing gasket guards against spills - a pad on the bottom of the container absorbs excess liquid
- Labelled "Chemotherapy Waste"
- Nest unused containers inside each other for stacking
- Made of polypropylene plastic - dispose by incineration

Item #	Capacity	Dimensions (W x H x D)	Qty
9605-10 A	2 gallon	10-1/8 x 9-1/2 x 6-3/4"	20
9607-01 B	8 gallon	15 x 17 x 10-1/4"	1
9607-10	8 gallon	15 x 17 x 10-1/4"	10

SharpStar™ Sharps Containers

- Minimize the potential for over-filling by stopping in the "full" position
- The "always-open" lid is ready for quick disposal
- Large opening easily accommodates 60 mL syringes
- Extended flap keeps hands away from the container when locking
- Tamper resistant opening
- Smart choice for USP 797 compliance
- Complete system (item # 9600-01) includes a wall enclosure with lock, large glove dispenser, a 5 qt. (4.73 liters) transparent red sharps container and an in-service sticker

Item #	Capacity	Dimensions (W x H x D)	Qty
9601-01 C	5 quart	10-3/8 x 9-1/8 x 3-3/4"	1
9601-06	5 quart	10-3/8 x 9-1/8 x 3-3/4"	20

Biohazard Sharps Disposal Containers

- Labelled "biohazard"
- Nest unused containers inside each other for stacking
- Complies with OSHA regulations for handling sharps
- 0.95 L (Item # 9604-01 and 9604-10) has a clear hinged lid with a variety of openings in different sizes for disposal of needles, lancets, butterfly tubing, and small syringes
- Made of polypropylene plastic - dispose by incineration

Item #	Capacity	Dimensions (W x H x D)	Qty
9602-01 D	2 gallon	10 x 9-3/4 x 6-7/8"	1
9602-06	2 gallon	10 x 9-3/4 x 6-7/8"	20
9603-01 E	8 gallon	15 x 17 x 10-3/8"	1
9603-04	8 gallon	15 x 17 x 10-3/8"	10
9604-01	1 quart	3-3/4 x 6 x 3-3/4"	1
9604-10 F	1 quart	3-3/4 x 6 x 3-3/4"	100



Leaktight Sharps Containers

- Material - Translucent polypropylene helps determine fill level to prevent overfilling.
- Closure - Snap-tight lid allows easy closure for final disposal. Protective iris flange opening prevents insertion of inappropriate non-medical waste.
- Special Feature - Used sharp drops into the puncture-resistant plastic container needlepoint first and eliminates all unnecessary repositioning and excessive handling.

Item #	Capacity (Litres)	Dimensions (W x H x D)	Qty
8219	2 quart	3-1/2 x 10 x 3-1/2"	1



Flip Top Sharps Container

- Flip top lid closes securely to prevent spilling or leaking; ideal for transport
- Red polypropylene plastic
- Includes an orange and black biohazard sticker on the front of the container
- Autoclavable and can be incinerated - should be disposed of in accordance with local guidelines
- Smart choice for USP 797 compliance

Item #	Capacity	Dimensions (W x H x D)	Qty
9083	1 quart	Overall: 4-1/2 x 8-3/4 x 2-1/2, Fill Opening: 11/4 x 13/4	20

Container holds approximately 30 of 3cc syringes, as well as other sizes and quantities



Disposable Ampule Breaker

- Ampules can be safely opened by snapping the top of the ampule breaker to the side; thus breaking the top of the ampule off at the neck of the bottle - top of the ampule can then be discarded along with the ampule breaker
- Reduces the chance of finger cuts and cross contamination
- Disposable - eliminates need for sterilization
- Made out of polypropylene plastic

Item #	Dimensions	Qty
10262	2 x 1-1/4"	100



Needle Resheather | 7375

- Smart Design - Allows single-handed uncapping and recapping of needles. Securely grips needle, phlebotomy and intravenous catheter caps. Complies fully with OSHA standards.
- Use Anywhere - Base can be adhered to any clean smooth surface. Double-sided tape included.
- Easy to Clean - The top portion of the unit can be removed from the base and steam autoclaved, gas sterilized or disinfected by alcohol.
- Packaging - Sold individually
- Dimensions - 2½"W x 3"H x 2¼"D

Biohazard Leakproof Bags

- Closure - Adhesive closure with perforated tear zone.
- Special Feature - When closed correctly, bags are 100% leakproof bags and include a document pouch for important paperwork.

Item #	Thickness	Dimensions (W x H)	Qty
20426	2 mil	6 x 9"	100

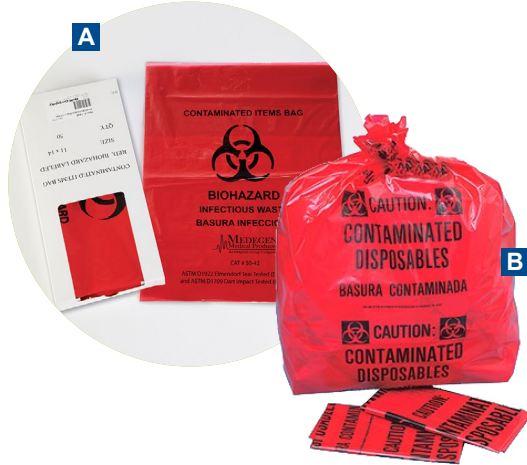

Biohazard Bags

- Meets performance criteria established by OSHA
- Small (Item # 7446) has a fold over flap for closing
- Can be secured closed with a heavy duty security seal with prongs (see Item # 7836)

Item #	Thickness	Dimensions (W x H)	Qty
7446	A 11/2 mil	11-1/4 x 14-1/2"	50
7445	B 4 mil	20 x 39 x 121/4"	25

Stick-On Biohazard Bag

- Includes an adhesive strip to stick to carts, cabinets, walls, etc.
- When bags are full, the top flap folds over and a second adhesive safely seals the bags

Item #	Thickness	Dimensions	Qty
9938	2 mil.	12" W x 14" H	100

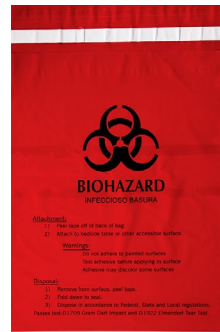

Chemo Waste Bag

- Ideal for safe and economic disposal of chemo waste
- 20 gallon capacity

Item #	Thickness	Dimensions	Qty.
9617-10	4 mil	23 x 41-1/2" (opens to 31")	100

Chemobloc™ Safelock Drug Transport Bags

- Provides safe storage and transport of cytotoxic medications
- Reclosable with a single track zipper closure
- Write on area for patient information
- See more patient information bags on pages 39 & 43 in the Poly bags section

Item #	Thickness	Measures	Quantity
9490	4 mil	6" x 9"	100
9491	4 mil	12" x 15"	250



Chemotherapy Transport and Batch Bags

- Heavy-duty clear reclosable bags provide a secure closure
- Latex free

Item #	Thickness	Size	Qty
CT6X9	A 4 mil	6 x 9"	100
CT12X15	B 4 mil	12 x 15"	100
CT6X9M	4 mil	6 x 9"	1000
CT12X15M	4 mil	12 x 15"	1000

Chemotherapy Disposal bags

- Clear polyethylene bags with yellow blocks that contain bilingual (French and English) black print
- Chemotherapy disposal bags are used for transporting, storing, and disposing items used in chemotherapy prep or administration

Item #	Thickness	Size	Qty
9516	4 mil	9 x 12"	100
9516M	4 mil	9 x 12"	1000
9517	C 4 mil	12 x 15"	100
9517M	4 mil	12 x 15"	1000

Chemo Prep Mats

- Provides an ideal surface for working under the hood or with a patient
- Surface of the three ply mat is firm and flat, with a penetrable mesh top layer, second layer is an absorbent gauze, and the bottom layer is non-permeable plastic
- Non-linting
- Smart choice for USP 797 compliance

Item #	Size	Qty
9621-01	17"W x 11"H	50
9622-01	D 22"W x 16"H	50

ChemoSorb Pad

- Pads are impregnated with a solidifying agent that absorbs and transforms liquid to gel, making cleanup and disposal safe
- Lint and latex-free
- Disposable - for single use only

Item #	Size	Qty
12035	E 12 x 12"	20



Economy Emergency Spill Kit | 7464-01

- Perfect for small spills that need immediate attention
- Intended for one time use only

Kit Includes

- 1 Bio-Wipe™ Bag
- 1 pair of latex free nitrile gloves
- 13.75 x 17.75" waffle-design paper towelette
- 1 antimicrobial hand wipe
- 2-ounce spray pump bottle of Cavicide® Cleaner
- Instruction sheet



Basic Chemo Spill Kit | 9961-01

- Perfect for small spills that need immediate attention
- Packaged in a large zip-it bag for quick and easy access
- Intended for one time use only

Kit Includes

- 1 fluid impervious gown
- 1 pair of chemo-nitrile gloves
- 1 impermeable mask with safety shield
- 1 Chemo Bio-Wipe™ Bag
- 3 absorbent towelettes
- 1 hard surface disinfectant wipe
- 1 chemo waste bag with twist tie
- 1 antimicrobial hand towelette
- 1 set of instructions for using the spill kit safely



Beard Guards

- Ideal to cover beard, mustache, and sideburns
- Comfortable elastic strap loops behind ears
- Universal size
- Material - Polypropylene

Item #	Colour	Qty
12077-31	Blue	100



Plastic Shoe Covers

- Ideal for electronics processing, food processing, hospitals, laboratories, inspections and maintenance
- Elastic on top for easy usage and removal
- Textured bottom for skid resistance
- Flexible material for easy movement
- Made out of non-woven polypropylene

Item #	Size	Qty
S741	Universal	500 pairs

Disposable Isolation Gown

- Disposable gown meets AAMI PB70 Level II barrier protection
- Gown made of non-woven material with full back closure.
- Features: Flat belt, elastic cuffs and tie-on neck closure.

Item #	Size	Qty
GW100Y	L	10
GW10Y	L	100



Personal Protection Gown

- Disposable gown has a stirrup cuff design to give the wearer added protection to the wrist area
- Back panel is open for cool comfort during long periods of wear
- Slip-on style neck loop (the shoulder panel at back is perforated for quick and easy removal)
- Made of embossed polyethylene, latex-free that passes ASTM F1670-95 standards

Item #	Size	Qty
20497	Universal	50

Nitrile Medical Examination Gloves

- Textured for extra grip and dexterity
- Excellent tensile strength and touch sensitivity
- Specify size when ordering

Item #	Sizes	Colour	Thickness	Qty
GNSMS	S	Blue	4 mil	100
GNSMM	M	Blue	4 mil	100
GNSML	L	Blue	4 mil	100



Glove Box Holders

- Conveniently stores multiple boxes in one location
- Store several sizes or different types of gloves in one holder
- Designed with key holes for mounting
- Can be wiped clean with soap and water or hospital sanitizer
- Stainless steel designs are smart choices for USP 797 compliance

Item #	Box Capacity	Description	Dimensions (W x H x D)
7468-01	A	White Enamel	10-7/8 x 10 x 4"
7466-01		Clear Plexiglas	10-7/8 x 10 x 4"
7474-01		Stainless Steel	16-1/8 x 10 x 4"
7461-01	B	White Enamel	16-1/8 x 10 x 4"
7467-01		Clear Plexiglas	16-1/8 x 10 x 4"
11948	C	Stainless Steel	22-1/4 x 10 x 3-3/4"
11949		White Enamel	22-1/4 x 10 x 3-3/4"
11950		Clear Plexiglas	22-1/4 x 10 x 3-3/4"

Wire Glove Box Holders

- Stainless steel holder with tough white plastic coating
- Can accommodate a variety of glove box sizes
- Open design allows for carton copy to be readable

Item #	Box Capacity	Description	Dimensions (W x H x D)
8245	D	Horizontal	11 x 14 x 4
7430-01	E	Horizontal	11.25 x 4.25 x 3.5

All Purpose Bulk Dispenser, Single Compartment

- Provides bulk storage for gloves, bouffant caps, shoe covers, hair nets, etc., to help reduce restocking and keep supplies stored in high-use areas
- Hinged lid provides dust protection and flips up for easy refill
- Dispensing window in the lower front allows quick access
- Place on counter or mount to most surfaces using the two key hole slots on the back panel

Item #	Material	Dimensions (W x H x D)
7426-01	F PETG	12-1/4 x 17 x 6"

Sanitizing Station

- Encourages infection prevention by providing protection supplies in waiting areas
- Clear PETG plastic - easily view inventory
- Hang using the keyhole slots or place on a counter or desktop
- Non-skid feet
- Can hold up to two earloop style face mask boxes, two tissues boxes or one box of gloves and a hand sanitizer bottle

Item #	Dimensions (W x H x D)
10383	G 15 x 8-1/4 x 5-3/4"



Personal Protection Door Caddies

- Neatly store protective apparel supplies for easy access and retrieval
- Improves personal protection practices
- Conveniently holds gloves, masks, gowns, medical waste bags, hand sanitizers and other miscellaneous items on the door
- Keeps hallways free from supply cart congestion and eliminates violations of fire, logistics and regulatory codes
- Hangers adequately hold the weight of the caddy with contents and allow doors to close securely
- Material - Flame-retardant nylon
- Can be wiped clean with surface disinfectant

Item #	Capacity	Dimensions
17677	A 3 pockets, 3 glove pockets, space for signage	33 x 17
17678	B 6 pockets, 3 glove pockets, space for signage	33 x 25
17679	C 3 pockets, 3 glove pockets, space for signage, 2 large gown pockets on back	33 x 18-1/2



Aluminum Protective Apparel Organizer

- Holds up to four boxes of gloves, two boxes of face masks and also has a dispensing slot for gowns
- Hanging supply caddy is designed to mount to the wall using the keyhole mounts or hang on a door using the optional door hanger (#18310, sold separately) and provide quick access to supplies
- Aluminum organizer and hanger are painted grey, with a powerful antimicrobial paint that can simultaneously kill disease-causing bacteria, mold, fungi and viruses

Item #	Description
18309	D Aluminum Protection Organizer 26-3/4"W x 21"H x 4-1/2"D
18310	Aluminum Door Hanger for 18309 5-1/2" W x 12-1/2" L

Personal Emergency Eyewash Stations

- Provides emergency care any time a person's eyes or face may have been exposed to corrosive, toxic, or caustic chemicals
- Ideal for use in proximity to work areas for immediate eye flushing until a larger, plumbed eyewash station can be reached
- #10076 includes a plastic holder, 32 oz (944mL) sterile isotonic eye wash station and 4 screws for mounting the station. Measures: 12¼" W x 14" H x 3" D
- #10077 – 32 oz (944mL) filled replacement bottles for #10076 eye wash station with easy-to-open screw top

Item #	Description
10076	E 32 oz. Emergency Eyewash Station
18901	F 16 oz. Emergency Eyewash Station
10077	32 oz. Filled Replacement Sterile Solution



Deluxe Safety Goggles

- Soft vinyl goggles with perforations for maximum ventilation
- Offers comfort and protection from flying particles, dust, and splash
- Fits comfortably even over large size prescription glasses
- Optical quality plastic lens

Item #	Description
35140	Deluxe Goggles



Deluxe Safety Goggles

- ChemoPlus protective wrap around goggles
- Durable plastic construction
- Splash-resistant
- One size fit - comfortable fits over most eyeglasses
- Ventilated - reduces chance of fogging
- Recommended for USP <797> compliance

Item #	Description
9630-01	Goggles

Latex Finger Cots

- Designed to protect fingers and fingertips from contaminants, as well protect finger dressings
- Includes assorted sizes (XS, S, M, L)

Item #	Qty
PS214	24



Multi-Cut Utility Shears

- Stainless steel blade, ideal for cutting bandages, dressing, fabric, or other tough material
- Colours available: ● black, ● blue, ● orange, ● pink, ● purple, ● red and ● yellow -specify when ordering

Item #	
95-105	A

Handle Universal Scissors

- Stainless steel blade

Item #	Size
S3115	B 5-1/2"

Digital Thermometer, °C/°F

- For axillary or oral use only
- Large and easy to read liquid crystal display
- Fast and accurate - 10 seconds read time

Item #	Description
PS720 A	Flex Tip Digital Thermometer
PS730 B	Digital Thermometer

Surgical Masks

- Lightweight and easy to use
- Elastic ear loops
- Pleated design for maximum comfort

Item #	Quantity
PS345 C	10
B344	50

Universal Face Mask Box Holder

- Versatile - Securely holds a single box of face masks in a wide variety of sizes.
- Compatible - Works with boxes no larger than 8"W x 5½"H x 5½"D and no smaller than 6½"W x 4"H x 4½"D.
- Convenient - Can mount to most smooth surfaces using keyholes on the back.
- Material - Beige ABS plastic
- Dimensions - 8¼"W x 4"H x 5¾"D

Item #	
20336 D	

Reusable Face Mask

- 2 per package
- Material: Double layer fabric
- Not to be shared. Single person use only

Item #	Description
B341 E	Junior mask Size

Face Mask Ear Relief Bands

- 10/package
- Size: 8½"L x 1¼"H

Item #	
20445 F	



PharmaSystems' Solutions for USP<797> Compliance: Sterile Preparations for Compounding Pharmacies

- USP chapter <797>, Sterile Preparations for Pharmaceutical Compounding, details the quality standards, conditions and procedures for compounding sterile preparations (CSPs) of drugs and nutrients in a cleanroom
- A cleanroom standard is enforced to prevent harm to patients that could result from microbial contamination, excessive bacterial endotoxins, variability in intended strength, unintended chemical and physical contaminants, and ingredients of inappropriate quality
- Cleanroom classes vary based on the nature of the operation, refer to the "compliance" below for product recommendations
- PharmaSystems® is proud to offer a range of cleanroom supplies to achieve and maintain USP <797> compliance, select from:
 - **Dry Wiping and Spill Control**
 - **Glove and Surface Cleaning**
 - **Isolator and Hood Cleaning**

Amplitude™ Wipes

- **Use:** Ideal for spill kits and cleaning carts
- **Material:** Lightweight spunlaced cellulose/polyester
- **Features:** Economical option for general cleaning

Item #	Dimensions	Qty
18958	9 x 9"	300



Lint-Free Wipes

- **Compliance:** USP <797> equipment cleaning guidance standards
- **Use:** Ideal for cleaning lab equipment and medical instruments
- **Features:** Lint-free – no traces of fibre or residue

Item #	Dimensions	Qty
18699	4 x 4"	300
17509	9 x 9"	300
17503	12 x 12"	150



EcoClean Wipes®

- **Compliance:** ISO Class 5 (class 100) **Use:** Designed for critical care units and cleanrooms
- **Material:** 100% natural fibre
- **Features:** Environmentally friendly – 100% biodegradable
- Low-linting, highly-absorbent, durable
- Heat-resistant, autoclavable
- Quarter-fold design promotes proper wiping technique

Item #	Dimensions	Qty
17883	5 x 5"	100 sheets
17884	9 x 9"	300 sheets
17885	12 x 12"	150 sheets

Wipe Dispensers

- Ideal for patient rooms, labs and cleanrooms
- Clear PETG
- Available in countertop models with anti-slip bottoms, or wall-mount models to save valuable counter space (4 keyholes in back for mounting)

Item #	Description	Dimensions (W x H x D)
17886	A Countertop, 9 x 9" Wipes	95-/8 x 9-5/8 x 3-7/8"
17887	Countertop, 12 x 12" Wipes	12-5/8 x 12-5/8 x 3-7/8"
17888	B Wall Mount, 9 x 9" Wipes	10 x 10 x 4-1/2"
17889	Wall Mount, 12 x 12" Wipes	13 x 13 x 4-1/2"

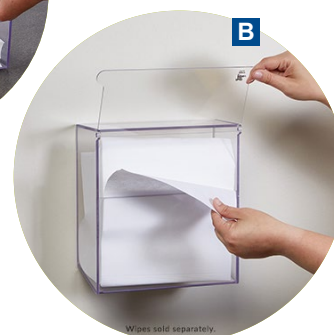

Double-bagged inside a sterile, peelable outer bag and linear tear inner bags, ready to introduce in cleanroom

SterileSorb™ Wipes

- **Compliance:** ISO Class 5
- **Use:** Achieve USP <797> compliance
- Ideal for general purpose cleaning in critical environments: cleanrooms, labs, and compounding pharmacy areas
- **Material:** Nonwoven, cellulose/polyester
- **Features:** Sterile
- Extremely absorbent – low in extractable residues and particles for maximum efficiency in cleanroom settings
- Ideal choice for spill kit packaging

Item #	Dimensions	Qty
18956	9 x 9"	25
18957	12 x 12"	25

Pro-Wipe® All-Purpose Low Linting Wiper, Perforated

- 250 sheets per pack; 4 packs per case
- Durable and low linting with highly absorbent cellulose core
- Excels at absorbency of water and oil based solutions
- **Material:** 50% Rayon 50% Polyester

Item #	Dimensions
17783	9 x 15"



Prosat® Presaturated Wipes

- **Compliance:** ISO Class 5 glove and surface cleaning
- **Use:** Ideal for use in critical healthcare areas: benches, hoods and equipment, as well as instruments and other articles prior to pass through
- **Material:** Non-woven, polypropylene
- **Active ingredients:** Isopropyl alcohol 70%, deionized water 30%
- **Features:** Sterile
- Resealable pouches with tamper-evident labels



Item #	Dimensions	Qty
18713	9 x 11"	30



Presaturated Cleanroom Wipers

- **Compliance:** ISO Class 5 and above
- **Use:** Ideal for general-purpose cleaning, surface preparation or wipe down of articles during pass-through. Also effective for residue removal after detergent or disinfectant use
- **Material:** Non-woven, cellulose/polyester
- **Saturated with:** 70% semiconductor grade isopropyl alcohol (IPA) and 30% deionized water (DI)
- **Features:** Ensures consistent saturation and improved control of cleaning protocols
- Excellent strength and durability
- Higher saturation level to support critical solution contact time needed
- Peel and reseal pouches allow for single-wipe use and prevents solvent evaporation
- Lot number printed on each package for traceability and process accountability

Item #	Dimensions	Qty
17880	9 x 9"	75

Sterile Alcohol Spray Bottles

- **Compliance:** ISO Class 5 glove and surface cleaning
- **Use:** Wipedown of isolators, cabinets, laminar flow hoods and surfaces
- Use on gloved hands in sterile suites
- Wipe down of products and equipment for pass through to controlled environments
- Ideally suited for use with sterile cleanroom wipes
- **Active ingredients:** 70% by volume USP Grade Isopropanol (IPA) and 30% USP Grade Purified Water, filtered to 0.2µ
- **Features:** sterile alcohol spray, induction sealed to assure stability

Item #	Description	Capacity
17979 A	Sterile alcohol spray bottle	16 oz.
18627	Sterile alcohol spray bottle	32 oz.
20254 B	Sterile Isopropanol Alcohol, Flip-Top	16 oz



EasyReach™ Stainless Steel Cleaning Tool

- Achieve quick, effective, one-handed cleaning and disinfecting in critical areas where USP <797> compliance has been mandated
- Single piece stainless steel tool is easily passed through transfer hatches, requires no assembly and is maintenance-free
- Versatile low profile, 360 degree pivoting head ensures even the most awkward areas can be quickly reached with ease
- All components are chemical resistant, minimizing the risk of contamination from degradation
- Made from lightweight stainless steel
- Dimensions of cleaning tool: 17"L (432mm)

Applications: EasyReach™ is recommended for effective cleaning and disinfection of surfaces in:

- Isolators - rigid, flexible film, half suits
- Restricted Access Barrier Systems (RABS)
- Filling Lines
- Laminar Air Flow Hoods
- Bio-Safety Cabinets
- Glove boxes
- Incubators
- Clean air hoods

Item #	Description	Qty
18273	EasyReach™ Stainless Steel Cleaning Tool	1
18274	Quilted Polyester Cleaning Pads	60/pack (15 bags of 4 wipes)
18275	Sterile Quilted Polyester Cleaning Pads	60/pack (15 bags of 4 wipes)
18276	Sterile Presaturated Cleaning Pads 70% IPA	64/pack (8 bags of 8 wipes)

Wipes

- Cleaning Pads have a specially designed tab for quick, easy fitting to the 7" mophead frame with gloved hands
- Pads are available in three styles: regular, sterile, and sterile presaturated
- The well-fitted quilted polyester pad ensures effective, even surface coverage reducing the number of viable and non-viable contaminants and ensuring maximum residue removal
- Double bagged, laundered, validated sterile, single-use cleaning pads ensure no burden is added to the critical environment
- Presaturated EasyReach™ Cleaning Pads eliminate the need for 70% IPA spray, minimizing transfer of materials and simplifying cleaning procedures.



EasyClean® 360 Isolator Cleaning Tool & Covers

- Ideal for efficient cleaning in areas where USP <797> compliance has been mandated such as compounding isolators, biological safety cabinets, laminar flow hoods and other controlled hospital pharmacy environments critical to the quality and purity of compounded products
- Compact with a durable stainless steel mop head that swivels 360° for easy maneuverability in tight spaces
- Includes 14" and 24" lightweight anodized aluminum handles, and features a quick-connect mechanism for easy attachment after pass through
- Mop head handles can be sterilized by autoclave or gamma radiation

Item #	Description
18708	EasyClean® 360 Isolator Cleaning Tool
18709	Non-Sterile Mop Head Covers 25 disposable covers & 1 padded cover
18710	Sterile Mop Head Covers 10 disposable covers & 1 padded cover

Cleanroom & Floor Marking Tape

- Construction - 2" wide polyester vinyl with rubber adhesive.
- Improve Visibility - Striped floor marking tape can help designate critical areas such as entry to cleanrooms, isolation areas, cart storage, etc. Adheres well to all surfaces.
- Options - Available with OSHA standard warning striped colors: Black/Yellow stripe and Red/White stripe. Specify color when ordering.
- Packaging - 18 yards per roll, 3 rolls per package (54 yards total)



Item #	Qty
18658	3



Peel Away Dirt & Dust Control Mats

- Construction - Designed with multiple sheets. When top sheet is contaminated, pull it off and discard.
- Prevent Contamination - Tacky surface pulls dirt and dust off shoes before they can contaminate a cleanroom.
- Packaging - 30 sheets per mat, 4 mats per package (120 sheets total)

Item #	Size
17736	36 x 18"
7384	45 x 18"
17738	36 x 24"
17737	45 x 24"
17739	45 x 36"

Tacky Mats

- Construction: 2-mil thick sheets have adhesive coating with antimicrobial germicide that covers the full area of the mat
- Ready to use: mats remove dirt, dust and lint on contact from shoes
- Quantity: 30 sheets per mat; 4 mats per package; 120 sheets total
- Tab system helps remove top layer

Item #	Size
5601-01	34 x 18"
5602-01	45 1/2 x 18"
5603-01	24 x 34"
5605-01	46 x 36"
5606-01	60 x 36"

Pre-op Mitt

- Convenient infection prevention mitt properly prepares a patient for surgery
- Adhesive palm picks up loose hairs and other foreign matter, providing a clean surgical field
- One size fits most

Item #	Measures	Qty
7441-01	7 x 5.5"	100



Personalized Namebadge

- Professional, easy to read pins
- Ideal for pharmacists, pharmacy technicians, assistants, and retail staff
- Includes pin back and magnetic back
- Can be personalized up to 3 lines, 30 characters per line
- Dimensions: 3" W x ¾" H

Item #	Description	Qty	UPC
Q116	A Rx	1	063636117887
Q117	B Mortar and Pestle	1	063636117870



Giftware



Baby Rx Booties

- Elastic ankle bands provide a just-right fit and keep toes cozy
- Contrasting RX logo is stitched inside heart
- Includes 2 sets of baby booties; 1 red and 1 white pair

Item #	Description	Qty	UPC
Y120	Booties	2 pairs	063636211202

Glass Coffee Mugs, Rx Symbol, 10 oz

- Boxed Set of 4
- 10 oz. glass with distinctive mortar and pestle and Rx logo etched onto the glass.

Item #	UPC
C532	063636253202



Pharmacy Wine Glasses |

- Set of 4
- 10.5 oz wine glasses
- Etched with pharmacy design
- Comes gift boxed.

Item #	UPC
H098	063636808914

Crystal Key Chain with Mortar and Pestle

- Mortar & Pestle 3-D image inside the crystal with unsurpassed craftsmanship. The perfect gift or recognition item they'll remember all the time!
- ¾"W x 1¼"H

Item #	UPC
12711	063636127114



Rx Key Chain

- Traditional design and silver accents give this key chain instant appeal while woven Rx design on blue fabric adds personality
- 4"

Item #	UPC
CC100	063636001001

Female Pharmacist Steel Sculpture Cardholder

- Recycled steel has been sculptured into a cardholder to provide a unique display stand for the female pharmacy professional's business cards. Each sculpture contains indigenous markings that showcase its originality.

Item #	UPC
18795	063636187958



Rosewood Pen Set, Personalized

- One ball point pen and one roller ball pen tuck neatly into the case
- Case can be personalized with logo and up to 2 lines of up to 30 characters per line including spaces
- Pens personalized with 1 line of up to 24 characters including spaces

Item #	UPC
Q166	063636011666

Super Hero Badge Reel Cover

- Ordinary ID badges get a fresh new look with interchangeable, professional-themed Badge Reel Covers that attach to matching Badge Reels (sold separately) with Velcro®
- Choose from two lanyard patterns (sold separately) to complete your badge makeover

Item #	Description	UPC
G309	A Super hero Badge	063636003098
G306	B Lanyard, black & white	063636003067



NEW PHARMACY RECOMMENDATIONS ORDER FORM

STARTER PACKAGE | ITEM # ORD1

ITEM #	ITEM DESCRIPTION
2998	Filter paper
3002	Graduated glass cylinder 10 ml
3006	Graduated glass cylinder 50 ml
3008	Graduated glass cylinder 100 ml
3016	Weighing paper
3017	Glass stirring rods 8" (3)
3091	Spatula rubber 4"
3042	Spatula stainless steel 4"
3028	Spatula stainless steel 6"
3029	Spatula stainless steel 8"
3030	Funnel (Plastic 55 mm) 2"
3031	Funnel (Plastic 100 mm) 4"
3073	Mortar & Pestle Glass Set 4 oz
3075	Mortar & Pestle Glass Set 8 oz
3076	Mortar Glass 16 oz
3086	Pestle Glass 16 oz
3088	Ointment Pad
3090	Weighing boats plastic 100/pk
VIC-303	EJ Series Electronic Scale, 300 gram capacity
CAL200	200g Calibration Weight
17751	Traceable® Temperature Recorder - Jumbo Display

DELUXE PACKAGE | ITEM # ORD2 (INCLUDES ITEMS FROM ORD1)

ITEM #	ITEM DESCRIPTION
20050-12	Bottles Amber Glass, 50 ml 264/case
200100	Bottles Amber Glass 100 ml 70/case
200200	Bottles Amber Glass 250 ml 96/case
200500	Bottles Amber Glass 500 ml 48/case
2001000-01	Bottle Amber Glass 1L
20020	White Lined Caps, 100/pk (For #20050-12 & 200100)
20022	White Lined Caps, 150/pk (For #200200)
20024	White Lined Caps, 55/pk (For # 200500)
20026	White Lined Caps, 25/pk (For #2001000)
3014	Glass Graduated Cylinder, 250 ml
3015	Glass Graduated Cylinder, 500 ml
3371	Glass Graduated Cylinder, 1000 ml
3098	Glass Ointment Slab, 12 x 12", 1/4" Thick
7782	7 ml Sterile Dropper Bottles With Dropper Caps, 12/case
7784	15 ml Sterile Dropper Bottles With Dropper Caps, 12/case
D-50	Tablet Counting Tray And Spatula
BK-50	Warning Label System & 20 Labels
T1-1	Tape Rx 1" x 36 Yds., 1" Core
T1-3	Tape Rx 1" x 72 Yds., 3" Core
Td1	Tape Dispenser For 1" Wide Tape (1" And 3" Core)
PRP-3	Rx Receipts 100/Pad x 10 Pads
11194	Small Box For Rx Prescription Pads (Each)
10196	Large Box For Rx Prescription Pads (Each)
1976	Rx Prescription Pad File Folder (Double Fold), 100/pk
5272	Anti-Fatigue Mat Ribbed Grey, 3' x 5'

SELECT PACKAGE	SELECT QUANTITY
<input type="checkbox"/> ORD1	<input type="checkbox"/>
<input type="checkbox"/> ORD2 (INCLUDES ITEMS FROM ORD1)	

PHARMACY NAME:		CONTACT NAME:	
ADDRESS:		PHONE:	
CITY:		FAX:	
PROVINCE:	POSTAL CODE:	EMAIL:	
DATE:	WHOLESALER:	ACCOUNT NO.:	

Please email or fax the completed order form to us.

orders@pharmasystems.com

fax: 1.888.475.7155

Please note: Shipping charges will be added to each order



pharmasystems.com

METHADONE SUPPLIES ORDER FORM

Item #	Description	Order Qty
Dispensettes		
DK107-13	Analog Dispensette, 0.5-5 mL Measures increments of 0.1 mL	
DK107-33	Digital Dispensette, 0.5-5 mL Measures increments of 0.02 mL	
DK107-10	Analog Dispensette, 1-10 mL Measures increments of 0.2 mL	
DK107-30	Digital Dispensette, 1-10 mL Measures increments of 0.05 mL	
DK107-50	Digital Dispensette, 10-25 mL Measures increments of 0.1 mL	
DK107-32	Analog Dispensette, 10-25 mL Measures increments of 0.5 mL	
DK107-16	Analog Dispensette, 5-50 mL Measures increments of 1 mL	
DK107-36	Digital Dispensette, 5-50 mL Measures increments of 0.2 mL	
DK-201	Dispensette Extended Filling Tube for use with bottles 1L or greater for DK107-13, DK107-33, DK107-10, DK107-30	
DK-205	Dispensette Extended Filling Tube for use with bottles 1L or greater for DK107-32, DK107-16, DK107-50, DK107-36	
Bottles		
200100	100 mL Amber Glass Bottles, 140/case	
10289	100 mL Amber Plastic Bottles without caps, 108/case	
10294	Tamper Resistant Caps 250 per case, for Amber Plastic Bottles	
2001000-01	1L Amber Glass Medicine Bottle (1)	
Dispensing Accessories		
7362	2 oz. Plastic Cups, with Graduations, 1000/case	
7360	3.5 oz. Plastic Cups, 100/case	
7361	5 oz. Plastic Cups, 50/case	
10203	3 mL Clear Oral Dispensers with tips, 100/case	
10205	5 mL Clear Oral Dispensers with tips, 100/case	
10210	10 mL Clear Oral Dispensers with tips, 100/case	
P-2	Methadone Label, 2 rolls of 500 per box	
1634AA-250	Glass Graduated Cylinder 250 mL, Class A Cylinder	
12281	Tamper Evident Tape Strips, 100/box	
8000	Red Tamper Resistant Tape, 1/2" wide, 108 ft. long	
8006	Red Tamper Resistant Tape, 1" wide, 108 ft. long	

PHARMACY NAME:		CONTACT NAME:	
ADDRESS:		PHONE:	
CITY:		FAX:	
PROVINCE:	POSTAL CODE:	EMAIL:	
DATE:	WHOLESALER:	ACCOUNT NO.:	

Please email or fax the completed order form to us.

orders@pharmasystems.com

fax: 1.888.475.7155

Please note: Shipping charges will be added to each order



pharmasystems.com