

**PharmaSystems®**

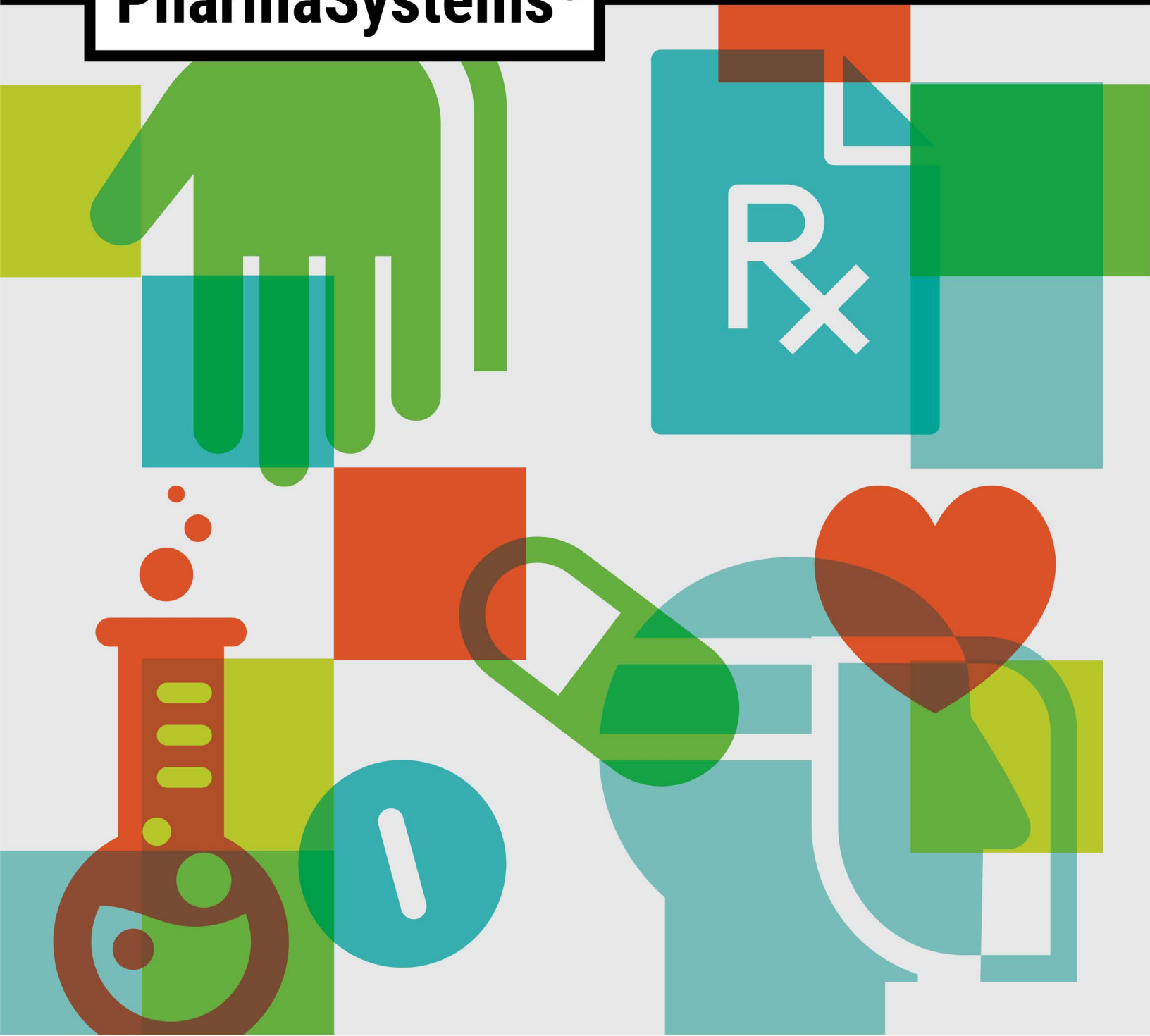

**PHARMACY  
SUPPLIES**



## Register an account to place your order today!

- View pricing: Simply register your account
- Place orders online through our online shopping cart, or by downloading a blank order form (return by fax or email)
- See new products: Be the first to know about new products
- Save on deals & promotions: Learn about new product promotions and take advantage of deals & clearance sales
- Stay informed: Keep up to date with changing Canadian Pharmacy Regulations and learn about product recommendations. Look out for the 'New Pharmacy Recommendation' tab.

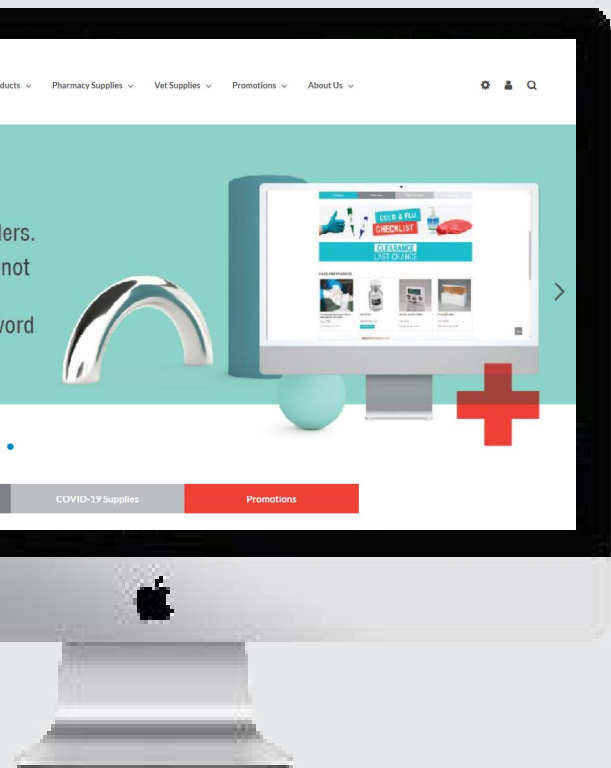

## How to order:

Phone in your order: 905.475.2500 | Toll free: 1.888.475.2500

Fax in your order: 905.475.7155 | Toll free: 1.888.475.7155

Email your order: [orders@pharmasystems.com](mailto:orders@pharmasystems.com)

Use the order form found on page 1

Place your order online: [www.pharmasystems.com](http://www.pharmasystems.com)

**Our bilingual customer service team is readily available to help you with any of your pharmacy supply requests!**

T: 905.475.2500 | Toll free: 1.888.475.2500

F: 905.475.7155 | Toll free: 1.888.475.7155

Address: 151 Telson Road Markham Ontario Canada L3R 1E7

Email: [orders@pharmasystems.com](mailto:orders@pharmasystems.com) | [info@pharmasystems.com](mailto:info@pharmasystems.com)

Website: [www.pharmasystems.com](http://www.pharmasystems.com)

**Wholesalers:** Most pharmacy products are available from your local drug wholesaler who may sell for more or less than the catalogue/website price. Drop ship prices are shown in the catalogue/website. Product not available from your wholesaler will be shipped from our warehouse facility in Markham, Ontario.

**Shipping Terms:** Orders will be shipped to all destinations in Canada. We reserve the privilege of shipping via the carrier of your choice.

**Prices:** Prices are subject to change without notice.

**Terms:** Net 30 days or as per your wholesaler

**Returns:** All returns to PharmaSystems must be authorized.

**Accessibility:** In meeting the needs of our customers and employees we strive at all times to provide our products in a way that respects the dignity of all individuals including persons with disabilities. In order to ensure equal treatment all PharmaSystems' customer service representatives and administrators are trained on policies, practices and procedures with respect to our commitment to people with disabilities.

# New Product

**ALERT!!!**

## Tamper Resistant Tape

- Ideal for hard to secure items such as jar tops, bottle caps, syringes, vials, etc.
- Tape molds easily to any item
- Pre-printed in black
- Packaged in an easy-dispensing box
- **See page 60 for more tamper resistant tapes!**

Item #	Width	Length	Qty	Colour	UPC
8008	1/2"	108 Feet	2 rolls	Red	063636080082



## Storage Information Label, Fridge

- Label reads "Fridge"
- Colour: Royal blue label with white text
- Quantity: 1000 labels per roll, 1 roll per box
- **See page 141 for more storage information labels!**

Item #	Size	UPC
CL-241	3/4"	063636002411

## Labeling Tapes

- Size: 1/2" x 500"
- Core Size: 1"
- Adhesive: Removable
- Unit of Measure: Roll
- Qty per UOM: 500
- Individually packaged
- **See page 151-152 for more options!**

Item #	Description	Colour	UPC
TP25	ATRAcurium ___ mg/mL	Orange	063636675875
TP10	Epinephrine ___ mg/mL	Light Purple	063636452896
TP23	Ketamine ___ mg/mL	Yellow	063636675462
TP04	Morphine ___ mg/mL	Blue	063636236540
TP29	Neostigmine ___ mg/mL	Orange/White	063636567453

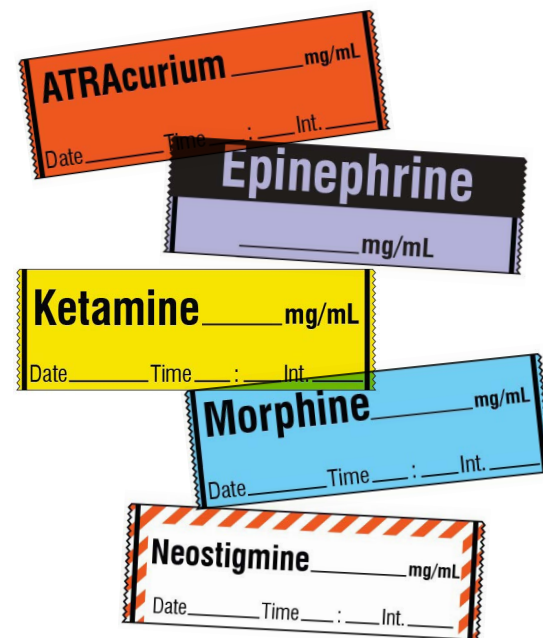

## Enteral Syringe with ENFit® Connector, Non-Sterile

- Supports enteral-route medication administration
- The clear barrel, dark print, and ENFit® design allows for easy drawing of medication and accurate dose delivery. For use with standard liquids or viscous fluids
- ISO 80369-3 compliant; designed to prevent misconnections
- Connector design provides secure connection to tube set
- Low Dose Tip (LDT) reduces the dead space, ensuring delivery accuracy for small doses (available in 6 mL and smaller)
- Colour: Clear with an orange plunger
- **Check out all our new ENFit® accessories on pages 95-96!**



Item #	Description	Size	Qty	UPC
99005	Enteral Syringe with ENFit Connector, Low Dose	0.5 ml	500	063636990053
99101	Enteral Syringe with ENFit Connector, Low Dose	1 ml	500	063636991012
99103	Enteral Syringe with ENFit Connector, Low Dose	3 ml	500	063636991036
99106	Enteral Syringe with ENFit Connector, Low Dose	6 ml	500	063636991067
99112	Enteral Syringe with ENFit Connector	12 ml	500	063636991128
99120	Enteral Syringe with ENFit Connector	20 ml	500	063636099121



## Hazardous Drug Bags

- Closure - Single-track reclosable zipper
- Safe Transport - Clear bags with preprinted warnings keep contents visible during transport and raise awareness for hazardous drug contents. Thickness adds another layer of protection
- Quantity: 100

Item #	Description	Size	Thickness	UPC
20414	Hazardous Drug Transport Bags	4 x 6"	4 mil	063636204143
20415	Hazardous Drug Transport Bags	12 x 15"	4 mil	063636204150
18488	Caution Hazardous Drug (RCRA) Bags	4 x 6"	2 mil	063636184889
20868	Caution Hazardous Drug (RCRA) Bags, Black	6 x 9"	2 mil	063636208684

## Packer Bottles with Pressure Seal Liners

- All-in-one packaging solution saves users from purchasing and storing bulk items separately.
- Caps feature a built-in liner that seals to the bottle without the need for special equipment
- Amber HDPE bottle protects light-sensitive contents
- 100 per package

Caps feature a built-in liner that seals to the bottle without the need for special equipment



Item #	Description	Colour	Size	UPC
20826A	Packer Bottles & Threaded Caps with Pressure Seal Liners	Amber	15ml	063636208264
20826N	Packer Bottles & Threaded Caps with Pressure Seal Liners	Natural	15ml	063636208226
20827A	Packer Bottles & Threaded Caps with Pressure Seal Liners	Amber	30ml	063636208271
20827N	Packer Bottles & Threaded Caps with Pressure Seal Liners	Natural	30ml	063636208776
20829A	Packer Bottles & Child Resistant Caps w/ Pressure Seal Liners	Amber	15ml	063636208295
20829N	Packer Bottles & Child Resistant Caps w/ Pressure Seal Liners	Natural	15ml	063636208998
20830A	Packer Bottles & Child Resistant Caps w/ Pressure Seal Liners	Amber	30ml	063636208301
20830N	Packer Bottles & Child Resistant Caps w/ Pressure Seal Liners	Natural	30ml	063636208332



### EJ Series Electronic Scales

- Select from 3 decimal place display (VIC-123, VIC-303) or 2 decimal display (EJ200, EJ410, EJ610)
- Measures by weight, percentage, counting, and density functions
- Sample key available for easy parts counting, percentage and totals
- Outputs weight data, GLP report and calibration report to printer or computer (additional accessories are required, contact us for details)
- Full digital calibration – calibration weight not included (See item #CAL100/CAL200)
- Easy levelling – adjust 4 feet

Specifications	
<b>Weighing Pan</b>	110 mm (round)
<b>Sensitivity Drift</b>	± 20 ppm/ °C (10-30°C)
<b>Min. % Display</b>	0.1%
<b>Display</b>	7 segment LCD with backlight
<b>Display Update</b>	10 times per second
<b>Operating Temperature</b>	-10°C - 40°C, less than 85% R.H.
<b>Power Supply</b>	AC adapter (included) or 4 x "AA" size dry-cell batteries (70 hours of battery life)
<b>Weight</b>	850 g
<b>Warranty</b>	5 years

Item #	Description	Weight Capacity	Minimum Display	Accuracy	Weighing Pan Size	UPC
VIC-123 <b>A</b>	Compact Balance with Lid	120 g	0.001 g	±0.001 g	110 mm	063636112301
EJ200 <b>B</b>	Compact Precision Balance	210 g	0.01 g	±0.01 g	110 mm	063636510206
EJ200C	Compact Precision Balance with Lid	210 g	0.01 g	±0.01 g	110 mm	063636510206
VIC-303	Compact High Precision Balance with Lid	310 g	0.001 g	±0.001 g	110 mm	063636703035
EJ410	Compact Balance	410 g	0.01 g	±0.01 g	110 mm	063636514105
EJ610	Compact Precision Balance	610 g	0.01 g	±0.01 g	110 mm	063636516109
EJ-11 <b>C</b>	Breeze Break for use with EJ Series Balances	-	-	-	-	063636001100

### A&D Precision Top Loading Balance

- Fast stabilization speed (1 second)
- Large bright vacuum florescent display
- Shock absorber function
- Statistical calculation function multiple weighing units
- Digital calibration function
- Counting function with ACAI (Automatic Counting Accuracy Improvement)
- Operating temperature - 5°C to 40°C (41°F to 104°F), 85% RH or less (No condensation)

Item #		Weight Capacity	Minimum Display	Accuracy	Weighing Pan Size	UPC
FX-300i <b>A</b>		320g	0.001g	±0.001g	130 mm	063636003005
FX-3000i <b>B</b>		3200g	0.01g	±0.001g	150 mm	063636783006
FZ-300i		320g	0.001g	±0.001g	130 mm	063636103002

### Calibration Weights

- For calibration of electronic balance scales
- Recommended for use with scales to meet the requirements of the College of Pharmacists
- **Contact us for details on additional weights and scales that meet ASTM standards**

Item #	Description	UPC
CAL100 <b>C</b>	100g Calibration Weight	063636821104
CAL100GS	100g with Certificate of Accuracy	063636100124
CAL200	200g Calibration Weight	063636820008
CAL200GS	200g with Certificate of Accuracy	063636100131

### Apothecary Weight Set

- Uniform density
- Low magnetic properties
- High resistance to wear and corrosion
- Includes: 10, 20, 50, 100, 200, 500 mg aluminum weights; ½, 1, 2, 3, 4, 5, grain aluminum links; 1, 2, 5, 10, 50 g.; 1, 2 oz., ½, 1 and dram, ½, 1 and 2 scruple brass weights; and tweezers

Item #	UPC
4027 <b>D</b>	063636740276



### Octagonal Stir Bars

- PTFE coated
- Features ALNICO V magnetic cores (Store in pairs to maintain magnetic strength, away from scales)

Item #	Size	Length	Diameter	UPC
86301	Small	1"	5/16"	063636863012
86315	Medium	1.5"	5/16"	063636863159
86302	Large	2"	5/16"	063636863029

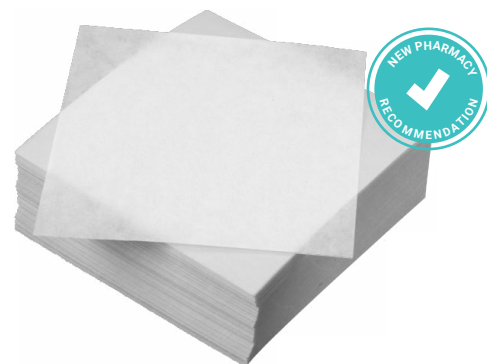
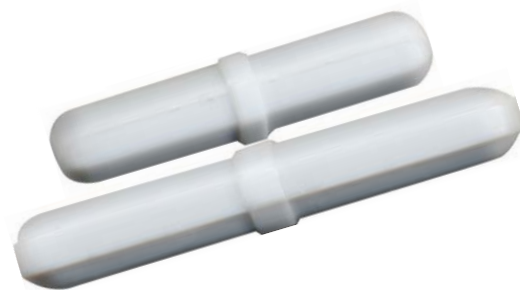

### Paper Glassine Polished

- Non-absorbent glassine weighing paper
- 500 per package

Item #	Size	UPC
3410	3" square	063636
3016	4" square	063636301606
3412	6" square	063636
68415	6" square	063636784157



### Plastic Weighing Boats

- Inexpensive, disposable containers
- Ideal for weighing quantities of ingredients
- Resilient, polystyrene construction ensures accurate control of pour-outs after weighing
- Non-stick surface is rugged enough for mixing
- Designed to easily stack and nest

Item #	Size	Dimensions	Qty	UPC
3420	Micro	4.4 x 4.4 cm	100	063636734206
40100	Small	4.5 x 4.5 cm	100	063636801007
3090	Medium	8.3 x 8.3 cm	100	063636730901
3092	Large	14 x 14 cm	100	063636730925



### Anti-Static Weighing Canoes

- Provides anti-static surface for weighing ingredients
- Unique canoe shape enables easy pouring
- Made of virgin polystyrene with 10 to 9 OHM/square resistivity, the ideal dissipative range (the property of anti-static)
- Non-stick surface is rugged enough for mixing
- 100 per package

Item #	Size	Dimensions (inches)	UPC
3421	Small	1.8 x 2.2 x 5	063636734213
3422	Medium	3.25 x 5.28 x 1	063636734220
3423	Large	4.25 x 7 x 1.17	063636734237

### Class A Graduated Cylinders

- High-quality autoclavable borosilicate glass cylinders
- Hexagonal base with 3 dimples for added stability
- White enamel graduations applied by laser, heat annealed, and inspected with code number to ensure accuracy
- Volume accuracy calibrated to contain (TC)
- Includes polyethylene hexagonal bumper guard (with the exception of the 5mL & 2000 mL size)
- Meets ASTM E-1272 Class A, Style I Specifications & USP Standards for Volumetric Glassware
- \*Recommended for methadone dispensing

Item #	Volume	Increments	Accuracy	Scales	UPC
1634AA-5	5 mL	0.1 mL	±0.05 mL	Single	063636163426
1634AA-10	10 mL	0.1 mL	±0.05 mL	Single	063636163433
1634AA-25	25 mL	0.2 mL	±0.15 mL	Single	063636163457
1634AA-50	50 mL	0.5 mL	±0.25 mL	Double	063636163464
1634AA-100	<b>A</b> 100 mL	1 mL	±0.4 mL	Double	063636163488
1634AA-250*	250 mL	2 mL	±1 mL	Double	063636163495
1634AA-500	500 mL	5 mL	±2 mL	Double	063636163525
1634AA-1000	1000 mL	10 mL	±3 mL	Double	063636163532
1634AA-2000	2000 mL	20 mL	±6 mL	Double	063636163549

### Class B Graduated Cylinders

- High-quality autoclavable borosilicate glass cylinders
- Detachable hexagonal sturdy base absorbs impact
- Includes protective hexagonal bumper guards
- White enamel graduations, applied by machine, heat annealed
- Volume accuracy calibrated to contain (TC)
- Meets ASTM E-1272 Class B, Style I Specifications

Item #	Volume	Increments	Accuracy	Scales	UPC
CYGPB-10	10 mL	0.1 mL	±0.1 mL	Single	063636882211
CYGPB-25	25 mL	0.2 mL	±0.3 mL	Single	063636881252
CYGPB-50	50 mL	0.4 mL	±0.4 mL	Double	063636818500
CYGPB-100	<b>B</b> 100 mL	1 mL	±0.6 mL	Double	063636817107

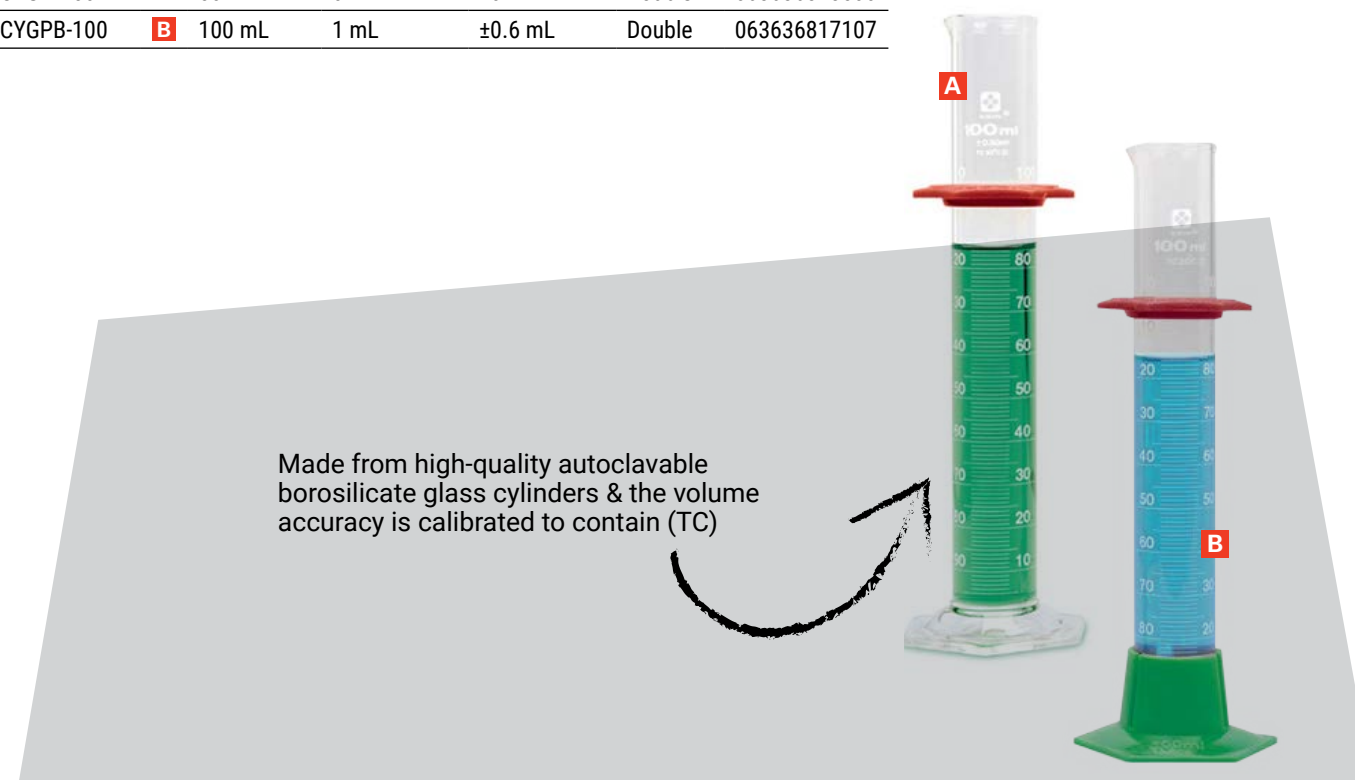



### Bell & Conical Glass Cylinders

- Bell and conical shaped glass graduated cylinders, with easy-pour spouts
- Bell shape has a controlled diameter – recommend for accuracy
- Bell-shaped cylinders have single scale white enamel graduations, manually applied and annealed for accuracy
- Conical-shaped cylinders have single scale molded graduations
- Volume accuracy calibrated to contain (TC)
- Flint conical glass cylinders cannot be autoclaved

Item #	Volume	Shape	Material	Increments	UPC (063636)
3360	5 mL	Bell	Borosilicate	1 mL	063636833602
3361	10 mL	Bell	Borosilicate	0.5 mL	063636833619
3362	25 mL	Bell	Borosilicate	1 mL	063636833626
3019	50 mL	Conical	Flint	5 mL	063636830199
3021	100 mL	Conical	Flint	5 – 25 mL	063636830212
3022	250 mL	Conical	Flint	10 – 50 mL	063636830229
3023	<b>A</b> 500 mL	Conical	Flint	25 – 50 mL	063636830236
3363	<b>B</b> 1000 mL	Bell	Borosilicate	20 mL	063636733636

### Glass Cylinders

- High-quality autoclavable borosilicate glass
- White enamel graduations, applied by machine, heat annealed
- Volume accuracy calibrated to contain (TC)
- Round base
- Meets Class B specifications

Item #	Volume	Increments	Scales	UPC
3002	10 mL	0.2 mL	Single	063636830021
3009	25 mL	0.5 mL	Single	063636830090
3006	50 mL	1 mL	Single	063636830069
3008	100 mL	1 mL	Single	063636830083
3014	<b>C</b> 250 mL	2 mL	Single	063636830144
3015	500 mL	5 mL	Single	063636830151
3371	1000 mL	10 mL	Single	063636833718

### Clear Plastic Graduated Cylinders

- Polymethylpentene (TPX) plastic cylinders are highly resistant to chemical attack (at room temperature)
- Sturdy hexagonal base
- Clear plastic with molded graduations
- Can be sterilized by autoclaving (120°C), gas, and radiation – not autoclavable by dry heat
- Can hold a maximum temperature of 175°C
- Volumes calibrated to deliver (TD)

Item #	Volume	Increments	Accuracy	Scales	UPC
3040	10 mL	0.2 mL	±0.2 mL	Single	063636830403
3435	25 mL	0.5 mL	±0.5 mL	Single	063636834357
3045	50 mL	1 mL	±1 mL	Single	063636830458
3046	100 mL	1 mL	±1 mL	Single	063636830465
3047	<b>A</b> 250 mL	2 mL	±2 mL	Single	063636830472
3048	500 mL	5 mL	±5 mL	Single	063636830489
3436	1000 mL	10 mL	±10 mL	Single	063636834364
3437	2000 mL	20 mL	±20 mL	Single	063636834371

### Plastic Graduated Cylinders

- Polypropylene cylinders are very resistant to effects of Alkalies
- Sturdy hexagonal base
- Can be sterilized by autoclaving (120°C), gas, and radiation – not autoclavable by dry heat
- Can hold a maximum temperature of 135°C
- Volumes calibrated to deliver (TD)

Item #	Volume	Increments	Accuracy	Scales	UPC
3431	10 mL	0.2 mL	±0.2 mL	Single	063636834319
3034	50 mL	1 mL	±1 mL	Single	063636830342
3036	100 mL	1 mL	±1 mL	Single	063636830366
3037	<b>B</b> 250 mL	2 mL	±2 mL	Single	063636830373
3038	500 mL	5 mL	±5 mL	Single	063636830380
3439	2000 mL	20 mL	±20 mL	Single	063636343903

### Cylinder Brushes

- Use to clean cylinders, graduates and bottles
- Sturdy wire handled brush with nylon bristles and tufted end for thorough cleaning
- Size includes handle

Item #	Description	Size	UPC
3049	<b>C</b> Small - For 50 mL Cylinders	11" (229 mm)	063636730499
3059	Medium - For 100-200 mL Cylinders	13" (330 mm)	063636730598
3066	Large - For 500 mL Cylinders	17" (438 mm)	063636730666



### Pitchers

- Transparent polypropylene plastic
- Handles for convenient lifting
- Autoclavable and chemically resistant
- Raised graduations

Item #	Volume	Increments	UPC
PIP-500	500 mL	5 mL	063636747053
PIP-1L	1000 mL	10 mL	063636747107
PIP-2L	2000 mL	50 mL	063636747206
40055	3000 mL	100 mL	063636700553
PIP-5L	5000 mL	250 mL	063636747503



### Clear Plastic Beakers

- Polymethylpentene (TPX) is highly resistant to chemical attack (at room temperature)
- Can be sterilized by autoclaving (120°C), gas, and radiation – not autoclavable by dry heat
- Molded graduations

Item #	Volume	Increments	UPC
BKTPX-50	50 mL	2 mL	063636790509
BKTPX-100	100 mL	5 mL	063636891008
BKTPX-250	250 mL	10 mL	063636792503
BKTPX-600	600 mL	10 mL	063636896003
BKTPX-1L	1000 mL	20 mL	063636740016
BKTPX-2L	2000 mL	50 mL	063636740023



### Glass Beakers

- Low-form Griffin borosilicate glass beaker with white enamel single scale graduations, applied by laser and heat annealed
- Shape and heavy wall construction offers optimum strength
- Spout for easy pouring
- Ideal for mixing and heating materials

Item #	Volume	Increments	UPC
3372	30 mL	10 mL	063636833725
3024	50 mL	10 mL	063636830243
3025	100 mL	10 mL	063636830250
3373	150 mL	25 mL	063636833732
3026	250 mL	25 mL	063636830267
3374	400 mL	25 mL	063636833749
3027	600 mL	50 mL	063636830274
3375	1000 mL	50 mL	063636833756



### Plastic Beakers

- Graduations are molded in milliliters
- Polypropylene beakers are very resistant to effects of Alkalies
- Can be sterilized by autoclaving (120°C), gas, and radiation – not autoclavable by dry heat

Item #	Volume	Increments	UPC
BKP-50	50 mL	2 mL	063636700508
BKP-100	100 mL	5 mL	063636821005
BKP-250	250 mL	10 mL	063636822507
BKP-600	600 mL	10 mL	063636826000
BKP-1L	1000 mL	20 mL	063636820015
BKP-2L	2000 mL	50 mL	063636820022
BKP-5L	5000 mL	500 mL	063636820053

### Stainless Steel Beakers

- Durable, seamless construction, with easy-pour rim
- Will not break, leach product, or become marred inside
- Non-corrosive and rust resistant

Item	Description	UPC (063636)
18602	600 mL	186029
18604	2000 mL, with handle	186050
18603	4000 mL, with handle	186036



### Glass Stirring Rods

- Soft glass with rounded ends minimizes scratching

Item	Size	Qty	UPC
3017	8"	3	063636830175
3018	10"	3	063636830182

### Plastic Stirring Rods

- White polypropylene plastic
- Small and large spatulas form at each end

Item #	Size	UPC
39160	9.63" (24.5 cm) long	063636791605

### Stir Bar Retriever

- Ideal for use with stirring rods (see above)
- Encased in chemically resistant polypropylene
- Hand ring allows for hanging when not in use

Item #	Description	UPC
86398	18 inches (45.72 cm) long	063636863982

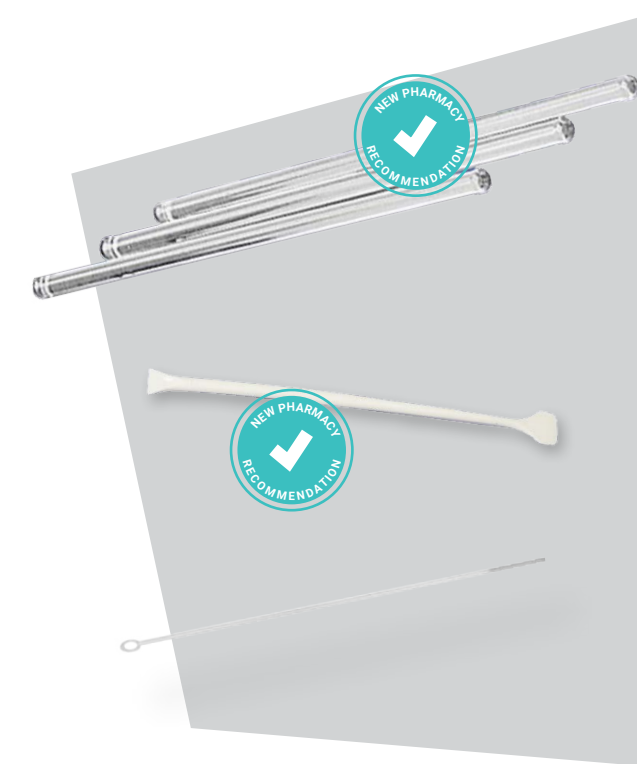

### Erlenmeyer Flasks

- White permanent graduations and large marking squares
- Made from high-quality borosilicate tubing with a low coefficient of expansion
- Volumes calibrated to deliver (TD)
- Meets ASTM E-1404 Type I, Class 1 specifications



Item #	Volume	Increments	UPC
24-125	125 mL	25 mL	063636741259
24-250	250 mL	50 mL	063636742508
24-500	500 mL	100 mL	063636745004
24-1L	1000 mL	100 mL	063636710002
24-2L	2000 mL	250 mL	063636720001
24-5L	5000 mL	500 mL	063636750008



### Volumetric Flasks

- Class A volumetric flask, calibrated to contain (TC) with fitted polyethylene stopper
- Borosilicate tubing provides uniform wall thickness resulting in optimum balance between thermal shock resistance and mechanical strength
- White enamel graduations

Item #	Volume	Accuracy	UPC (063636)
2415-10	10 mL	±0.02 mL	063636241513
2415-25	25 mL	±0.03 mL	063636241520
2415-50	50 mL	±0.05 mL	063636241551
2415-100	100 mL	±0.1 mL	063636751005
2415-200	200 mL	±0.15 mL	063636224158
2415-250	250 mL	±0.15 mL	063636250249
2415-500	500 mL	±0.25 mL	063636755003
2415-1000	1000 mL	±0.4 mL	063636750015
2415-2000	2000 mL	±0.6 mL	063636222413

### Plastic Funnels

- Lightweight polypropylene
- Durable, long stem design

Item #	Diameter	Capacity	UPC
3030	55 mm	55 mL	063636830304
3031	100 mm	100 mL	063636830311

### Heavy Duty Glass Funnels

- Ribbed on inner surface to increase flow

Item #	Diameter	Capacity	UPC
3061	7 cm	60 mL	063636730611
3063	9 cm	125 mL	063636730635
3065	11½ cm	250 mL	063636730659
35695-04	14½ cm	500 mL	063636795047
35695-05	14½ cm	100 mL	063636795054



### Filter Paper

- Use for filtration of coarse particles and gelatinous precipitates
- Standard qualitative filter papers suitable for quadrant fold or gravity flow applications
- Contains high level of alpha-cellulose that provides high purity, weakens when wet

Item #	Diameter	Grade	Particle Retention	Flow Rate	Speed	Rapidity	Qty	UPC
2994	110 mm	04	10 µm	Medium	34	200 mls/min	100	063636729943
2995	75 mm	04	10 µm	Medium	34	200 mls/min	100	063636729950
2998	110 mm	01	2.5 µm	Medium	124	55 mls/min	100	063636029999
2999	185 mm	01	2.5 µm	Medium	124	55 mls/min	100	063636029982
2996	240 mm	01	2.5 µm	Medium	124	55 mls/min	100	063636729967
2997	320 mm	01	2.5 µm	Medium	124	55 mls/min	100	063636729974

### pH Test Papers

#### Item # 90710

- 1-14 pH range test papers
- Supplied in a clear plastic vial container
- Includes colour guides in vial
- 100 test strips per vial
- Each test strip measures 3 x 12 mm

#### Item # 6080

- 6-8 pH range
- Double roll, hydron pH test papers
- Includes double roll dispenser
- Includes pH colour charts

Item #	Description	UPC
90710	<b>A</b> 1-14 pH range, 100 per vial	063636707101
6080	<b>B</b> 6-8 (neutral) pH range, double roll with dispenser	063636760809

#### Instructions for use of the test strip (item # 90710):

1. Use first morning urine
2. After a steady stream has started, wet the strip pad for 1-2 seconds
3. Gently shake off any excess fluid on the test strip and wait for 10-15 seconds
4. Compare/match the color of the test strip to the colour chart provided in the bottle. The number that corresponds to the color matched pad is the result.

The normal pH of urine is slightly acidic and gives a reading between 6.5-7.5. If the urine is on the alkaline side, the readings should correspond to colors indicating 7.5 or higher. Acidic urine gives color corresponding to 6.5 or lower. Please note that pH of urine is affected by the food and medication intake.



### Rubber Spatulas

- Hard, non-porous rubber spatula for compounding
- Recommended for use with compounds that react with metal
- Can be cleaned with soap and water, alcohol or by autoclaving

Item #	Blade Size	UPC
3091	<b>A</b> 4" (101.6 mm)	063636830915
3093	6" (152.4 mm)	063636830939
3095	8" (203.2 mm)	063636830953

### Spatula with Multi-Purpose Tool

- Includes swing-out multi-purpose cutting tool
- Tapered end ideal for use when counting tablets
- Blade and cutting tool are made of stainless steel, handle is made of rosewood
- Cutting tool measures 1 1/4"

Item #	UPC
1137	<b>B</b> 063636711375

### Stainless Steel Spatulas

- Flexible, dull curved edged, with a comfortable wood handle
- 4", 6" and 8" spatulas are recommended to meet the requirements of the College of Pharmacists

Item #	Blade Size	UPC
3042	4" (101.6 mm)	063636304249
3043	5" (114.3 mm)	063636304348
3028	<b>C</b> 6" (152.4 mm)	063636830281
3029	8" (203.2 mm)	063636830298
3429	10" (254 mm)	063636834296
3430	12" (355.6 mm)	063636834302

### Disposable Spatulas

- Unique hollow cores minimize thermal transfer
- Resistant to dilute acids and bases
- Autoclavable polypropylene can be used for sterile compounding

Item #	Description	Size	Qty	UPC
17946	<b>D</b> Disposable, Opaque	210mm	300	063636179465
17947	<b>E</b> Disposable, Blue	210mm	300	063636179472
17948	<b>F</b> Disposable, Green	310mm	150	063636179489



Flint Glass



Wedgewood

### Flint Glass Mortar & Pestles

- Convenient - Use for preparing medications for patients or compounding recipes.
- Easy to Clean - Can be sterilized, cleaned with alcohol or washed with soap and water.
- **Note:** Not recommended for use with drastic temperature changes.

### Wedgewood Mortar & Pestles

- Convenient - Use for preparing medications for patients or compounding recipes.
- Easy to Clean - Can be cleaned with alcohol or washed with soap and water. Pestles cannot be sterilized because of the wooden handle.
- **Note:** Wedgewood should not be used with flavors or scents because the porous material will retain these elements after they are cleaned.

### Mortar & Pestles

Item #	Description	Size	UPC
3070	Flint Glass Mortar	2 oz. (60 mL)	063636830700
3080	Flint Glass Pestle	2 oz. (60 mL)	063636830809
3071	Flint Glass Mortar & Pestle Set	2 oz. (60 mL)	063636830717
3072	Flint Glass Mortar	4 oz. (120 mL)	063636730727
3082	Flint Glass Pestle	4 oz. (120 mL)	063636730826
3073	Flint Glass Mortar & Pestle Set	4 oz. (120 mL)	063636830731
3074	Flint Glass Mortar	8 oz. (240 mL)	063636730741
3084	Flint Glass Pestle	8 oz. (240 mL)	063636730840
3075	Flint Glass Mortar & Pestle Set	8 oz. (240 mL)	063636830755
3076	Flint Glass Mortar	16 oz. (480 mL)	063636730762
3086	Flint Glass Pestle	16 oz. (480 mL)	063636830861
3382	Flint Glass Mortar & Pestle Set	16 oz. (480 mL)	063636033828
3053	Wedgewood Mortar & Pestle set	4 oz. (120 mL)	063636730536
3055	Wedgewood Mortar & Pestle set	8 oz. (240 mL)	063636730550
3395	Ceramic Mortar & Pestle set	2 oz. (60 mL)	063636733957
3398	Ceramic Mortar & Pestle set	4 oz. (120 mL)	063636733988
3401	Ceramic Mortar & Pestle set	8 oz. (240 mL)	063636734015
3404	Ceramic Mortar & Pestle set	16 oz. (480 mL)	063636734046
3407	Ceramic Mortar & Pestle set	32 oz. (960 mL)	063636734077

### Ceramic Mortar & Pestles

- Use for preparing medications for patients or mixing and pulverizing ingredients for compounding
- Ceramic models are ideal for compounding tablets and solids
- Can be sterilized, cleaned with alcohol, or washed with soap and water



Ceramic

### Ointment Pad

- 12" square
- 100 sheets per pad

Item #	Description	Qty	UPC
3088	<b>A</b> 12 x 12" Square	100 Sheets	063636308803

### Glass Ointment Slab

- Glass ointment slab suitable for mixing various preparations
- 12" square
- 1/4" thick

Item #	Description	UPC
3098	<b>B</b> 12" Square Slab, 1/4" Thick	063636830984

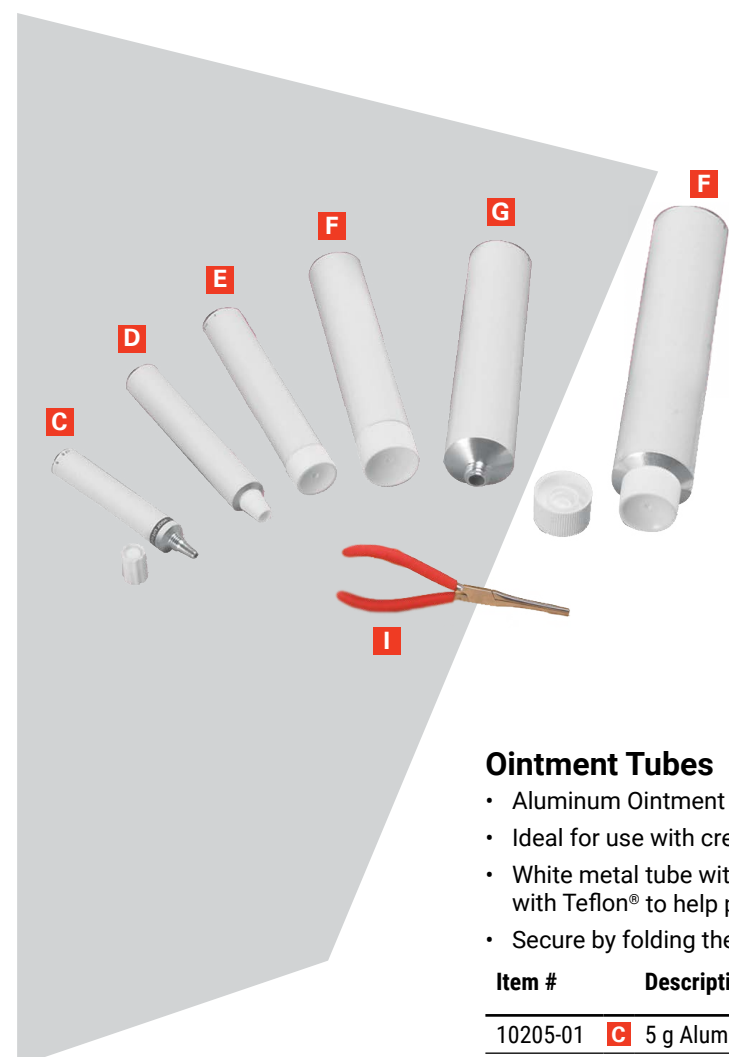
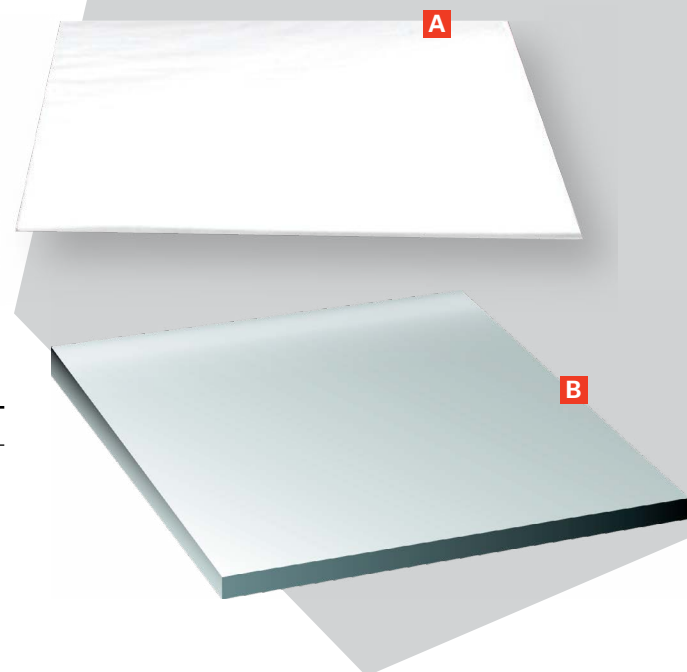

### Ointment Tubes

- Aluminum Ointment Tubes (A-F):
- Ideal for use with creams, ointments and topical medications
- White metal tube with white plastic screw cap and plastic ophthalmic tip - tubes lined with Teflon® to help prevent sticking or reactions with the aluminum; autoclavable
- Secure by folding the ends with tongs or pliers

Item #	Description	Qty	UPC
10205-01	<b>C</b> 5 g Aluminum Ointment Tube, with Tamper Evident Ring	135	063636702052
10206-01	<b>D</b> 10 g Aluminum Ointment Tube	100	063636702069
10201-01	<b>E</b> 15 g Aluminum Ointment Tube	117	063636702014
10202	<b>F</b> 30 g Aluminum Ointment Tube	12	063636702021
10203A	<b>G</b> 50 g Aluminum Ointment Tube	12	063636702038
10204-01	<b>H</b> 100 g Aluminum Ointment Tube	54	063636720414
4040	<b>I</b> Ointment Tube Pliers	1	063636740405

### Dispensing Containers and Accessories

- Built-In Safety - Bottom closure snaps shut for a tamper-resistant seal
- Maintain Freshness - Screw top lids keep ointments fresh until the last application
- Easy to Use - Simply twist the bottom of the container and the compound is expelled from the top of the container

Item #	Description	Qty	UPC
10332	<b>A</b> 30 g Dispensing Container	20	063636103323
10333	50 g Dispensing Container	20	063636103330
10334	100 g Dispensing Container	15	063636103347
10335	<b>B</b> 200 g Dispensing Container	10	063636103354
10330	<b>C</b> Large Mixing Disc	30	063636103309



### Ointment Jars

- Smart Packaging - Containers come shrink wrapped on paperboard trays to keep them clean and provide convenient storage
- Multi-Purpose - Ideal for packaging and dispensing ointments, gels and creams

Item #	Size	Qty	UPC
10083	25 mL	120	063636700836
10084	40 mL	80	063636700843
10085	55 mL	80	063636700850
10086	<b>A</b> 75 mL	35	063636700867
10087	120 mL	35	063636700874
10088	170 mL	35	063636700881
10089	<b>B</b> 250 mL	24	063636700898
10520	300 mL	10	063636705206
10521	<b>C</b> 690 mL	10	063636705213

### Dispensette III

- Easy, fast, and mechanically accurate liquid bottle-top dispenser
- Accurate to 0.5% of overall volumes
- Made with non-reactive Teflon®, resistant to wear and damage
- Ideal for dispensing liquid medication, especially methadone
- Long life span when properly maintained (see cleaning note)
- ISO/GLP compliant with certificate of pre-calibration; annual calibration recommended (see note below)

#### Features:

- 100% Teflon® tubing is non-reactive; ideal for use with methadone
- Recirculation tube prevents waste
- Safety valve prevents clogging and leaking
- Cap keeps out air, and prevents bacteria from growing and affecting methadone or other liquids



#### Recommendations:

- Digital units are recommended for ease of use and accuracy
- Item # DK107-30 is the size recommended for methadone dispensing
- Recommended to be used with 1 L amber glass bottle
- Use with Class A glass cylinders to verify accuracy of measurements (see page 9 for 1634AA series cylinders)

### One-Time Set-up Instructions:

**STEP 1**

Attach the adapters onto the bottle.

**STEP 2**

Assemble the discharge tube to the housing unit.

**STEP 3**

Attach the adjustable filling tube onto the housing unit.

**STEP 4**

Attach the recirculation tube onto the housing unit. Recirculation tube allows unused liquid to recycle back into the stock bottle without wasting any liquid.

**STEP 5**

Attach the housing unit onto the bottle adapter.

**STEP 6**

Set the valve to "off" mode for recirculation. Select the prescribed dosage amount. Recirculate the medication by pulling the housing unit upwards & downwards to prime the dispenser.

**STEP 7**

Set the valve to "on" mode, remove the safety cap and dispense the medication by withdrawing it upwards and dispensing it downwards.

**Important Cleaning Instructions:** Maintenance for this equipment is very important; especially when dispensing methadone. When each stock bottle is complete, we recommend that you circulate the dispensette with hot water. Methadone crystallizes when exposed to air; without proper cleaning, it can clog the machine over time resulting in incorrect calibration. Should this occur, do not force your Dispensette. If your Dispensette becomes clogged over time please contact PharmaSystems to schedule a cleaning. \*Refer to the instructions manual for full cleaning & care Instructions.

**Important Note about Calibration:** Dispensette includes certificate of calibration valid for 1 year after purchase. Annual calibration is recommended to ensure product accuracy. This service is offered by PharmaSystems for a fee. Please do not attempt to calibrate the Dispensette unless otherwise directed by a PharmaSystems employee as this will void your certificate of calibration.

#### Dispensettes Include:

Adjustable filling tube & recirculation tube (accommodates all standard bottle sizes below 1 litre)

Bottle adapters (24, 28, 33, & 38 mm)

Discharge tube

Vale mounting/calibration tool

Certificate of performance

1 year warranty against product defects (does not include user-handling errors)



#### Dispensettes

Item #	Type	Volume	Increments	Accuracy	Adapters Included	Filling Tubes Included	UPC
DK107-33	Digital	0.5-5 mL	0.02 mL	±25 µL	24, 28, 33, 38 mm	125-240 mm	063636707330
DK107-30	Digital	1-10 mL	0.05 mL	±50 µL	24, 28, 33, 38 mm	125-240 mm	063636707309
DK107-50	Digital	10-25 mL	0.1 mL	±125 µL	33, 38 mm	170-330 mm	063636707507
DK107-36	Digital	5-50 mL	0.02 mL	±250 µL	33, 38 mm	170-330 mm	063636707361
DK107-13	Analog	0.5-5 mL	0.2 mL	±25 µL	24, 28, 33, 38 mm	125-240 mm	063636707132
DK107-10	Analog	1-10 mL	0.02 mL	±50 µL	24, 28, 33, 38 mm	125-240 mm	063636701079
DK107-32	Analog	10-25 mL	0.5 mL	±125 µL	33, 38 mm	170-330 mm	063636707323
DK107-16	Analog	5-50 mL	1 mL	±250 µL	33, 38 mm	170-330 mm	063636707163

#### Accessories

Item #	Description	Compatible with models	UPC
DK-201	Extended filling tube accommodates 1 L, 2L and 4 L bottles	DK107-13, DK107-33, DK107-10, DK107-30	063636002015
DK-205	Extended filling tube accommodates 1 L, 2 L and 4 L bottles	DK107-32, DK107-16, DK107-50, DK107-36	063636002053
6747	Recirculation Tube for Dispensette III	All models	063636067472

### Medication Cups

Item #	Description	Type	Qty	UPC
7364	1 oz. / 29 mL Graduated	Plastic	1000	063636873646
7362	2 oz. / 59 mL Graduated	Plastic	1000	063636127626
5165	1 oz. / 29 mL Graduated	Plastic	400	063636751654
5165-01	1 oz. / 29 mL Graduated	Plastic	4800	-
<b>7360</b>	<b>3.5 oz. / 103 mL</b>	<b>Plastic</b>	<b>100</b>	<b>063636126612</b>
7361	5 oz. / 147 mL	Plastic	100	063636127619
7366	5 oz. / 147 mL	Plastic	1200	063636773663
7369	1 oz / 29 mL	Paper Souffle	1000	063636873691
7368	1/2 oz / 14 mL	Paper Souffle	1000	063636873684
7363	3 oz / 88 mL	Wax Paper	2400	063636073633
7363	3 oz / 88 mL	Wax Paper	2400	063636073633
5160	Lids for Narrow Cups	Plastic	400	063636751609
5160-01	Lids for Narrow Cups	Plastic	4000	063636751609



### Amber Glass Medicine Bottles

- 28 mm white plastic screw caps included

Item #	Description	Bottle Neck Size	Size	Qty	UPC
20050-12	Amber Glass	18 mm	50 mL	264	-
<b>200100</b>	<b>Amber Glass</b>	<b>18 mm</b>	<b>100 mL</b>	<b>140</b>	<b>063636200121</b>
200200	Amber Glass	24 mm	236 mL	108	-
200500-12	Amber Glass	28 mm	500 mL	12	-
<b>2001000</b>	<b>Amber Glass</b>	<b>33 mm</b>	<b>1 L</b>	<b>12</b>	<b>063636200114</b>
<b>2001000-01</b>	<b>Amber Glass</b>	<b>33 mm</b>	<b>1 L</b>	<b>1</b>	<b>063636710170</b>
20020	White Cap For use with 20050 & 200100			100	063636200213
20026	White Cap For use with 2001000 & 2001000-01			25	063636200206



### Amber Plastic Bottles, PET

- Bottle necks measure 24mm – compatible with E-28mm and F-28mm Adapta-Caps (see page 49 for details)

Item #	Description	Includes Caps	Qty	UPC
102893	100 mL Amber Plastic Bottles	✓	108	063636728939
<b>10289</b>	<b>100 mL Amber Plastic Bottles</b>	<b>-</b>	<b>108</b>	<b>063636702892</b>
102903	200 mL Amber Plastic Bottles	✓	63	063636729035
10290	200 mL Amber Plastic Bottles	-	63	063636702908
102913	300 mL Amber Plastic Bottles	✓	48	063636729134
10291	300 mL Amber Plastic Bottles	-	48	063636702915
102923	500 mL Amber Plastic Bottles	✓	35	063636729233
10292	500 mL Amber Plastic Bottles	-	35	063636702922
102933	1000 mL Amber Plastic Bottles	✓	30	063636729332
10293	1000 mL Amber Plastic Bottles	-	30	063636702939
<b>10294</b>	<b>Tamper Resistant Caps (Not child-proof)</b>	<b>-</b>	<b>250</b>	<b>063636702946</b>



### Amber Glass Dropper Bottles with Glass Dropper Caps

Item #	Description	Size	Qty.	UPC (063636)
19450	Amber Glass with Dropper Cap	5 mL	340	063636194505
19451	Amber Glass with Dropper Cap	10 mL	255	063636194512
19452	Amber Glass with Dropper Cap	20 mL	216	063636194529
19453	Amber Glass with Dropper Cap	30 mL	168	063636194536
19454	Amber Glass with Dropper Cap	50 mL	99	063636194543
19455	Amber Glass with Dropper Cap	100 mL	68	063636194550

### Amber Plastic Dropper Bottles

- Bottle caps have built-in droppers for dispensing or mixing
- Material: Polypropylene

Item #	Size (oz.)	Size (mL)	Qty	UPC
10078	½ oz	14 mL	12	063636800789
10079	1 oz	29 mL	12	063636800796
10080	2 oz	59 mL	12	063636800802



### Amber Glass Dropper Bottle Accessories

Item #	Description	Qty.	UPC
10067	<b>A</b> White Tamper Resistant Caps	100	063636100674
10068	Black Tamper Resistant Caps	100	063636100681
19456	<b>B</b> Glass Dropper or 5 mL Bottles	100	063636194567
19457	Glass Dropper for 10-30 mL Bottles	100	063636194574
19458	Glass Dropper for 50-100 mL Bottles	100	063636194581
19459	<b>C</b> Glass Dropper for item # 19453	100	063636194598



Screw-on caps have a tamper-evident ring that breaks off to show evidence of access.

Items highlighted in orange are recommended for methadone dispensing

### Sterile Amber Glass Eye Dropper & Bottle

- Ideal for preparing individual or small batches of extemporaneous ophthalmic solutions
- Dropper will remain sterile until the cover is removed from tip cap - cover is reusable, protects from contamination, USP 797 compliant
- Tip cap dispenses 50 µL per drop

Item #	Description	Qty	UPC
7789	<b>A</b> 10 mL Sterile Dropper & Bottle	10	063636877897



### Calibrated Dropper and Vial

- Dropper: Calibrated from 0.2 - 1 mL for accurate dispensing
- Suitable for pediatric and infant dosing
- Packaged individually
- Vial: Suitable for use with calibrated dropper
- Translucent, made of HDPE

Item #	Description	Qty	UPC
7785-01	<b>B</b> 1 mL Calibrated Dropper	10	063636777852
5703-04	<b>C</b> 30 mL Vial for Calibrated Dropper	10	063636757038

### Calibrated Window Vials

- 1 oz (30 mL) vial with unique clear window strip
- Allows users to quickly see the amount of medication in the container
- 25 per package

Item #	Description	UPC
17868	1 oz. Amber vial with white calibrated dropper cap	063636178680
17869	1 oz. White vial with white calibrated dropper cap	063636178697
17868-01	<b>D</b> 1 oz. Amber vial	063636917685
17869-01	1 oz. White vial	063636917869
17870-01	<b>E</b> White Calibrated Dropper cap	063636178703
17943-01	Black Calibrated Dropper cap	063636179434
17942-01	White Screw Caps for Calibrated Window Strip Vials	063636179427



### Vial Decappers

- Removes aluminum vial caps
- Made of forged steel for strength and durability, corrosion resistant nickel, and has a chrome plated finish, latex free
- Sizes below correspond to the vial neck diameter, or to the cap size to be removed

Item #	Size	UPC
7713	13 mm	063636877132
7714	20 mm	063636871406
7720	30 mm	063636877200



### Dual Action Vial Decappers

- Removes aluminum vial caps
- Economical and durable way to remove seals and stoppers that contain latex before preparing syringes for latex sensitive patients
- Sizes below correspond to the vial neck diameter, or to the cap size to be removed

#### Package includes:

- 1 x Twin Action Decapper Pliers (6 x 4 x 1 in)
- 2 x Cushioned Grips

Item #	Size	Colour	UPC
7771	8 mm, 13 mm	Red	063636877712
7772	11 mm, 20 mm	Blue	063636877729
7773	13 mm, 20 mm	Orange	063636877736
7774	8 mm, 30 mm	Green	063636877743
7775	8 mm, 11 mm	Purple	063636777524



### Amber Sterile Glass Vials

- Sterile Processed - Type 1, USP, borosilicate glass vials are dry-heat sterilized and pyrogen free
- Compatibility - Empty Sterile Vial stoppers are latex free
- **Note:** Caps are not included

Item #	Capacity	Cap Size	Qty	UPC
19806	2 ml	13 mm	25	063636198060
19813	5 mL	20 mm	25	063636870119
18702	10 mL	20 mm	25	063636187026
18703	30 mL	20 mm	25	063636187033
18704	50 mL	20 mm	25	063636187040



Amber

### Clear Sterile Glass Vials

- Sterile empty glass vials in compact, durable trays
- De-pyrogenated dry heat sterilization process (no drop of liquid inside) without cap for use in clinical trials
- For vial seals, see pages 55-56

Item #	Capacity	Qty	UPC
7760-10	2 mL	100	063636776015
7761-03	5 mL	25	06363677616
7761-10	5 mL	100	063636877613
7762-03	10 mL	25	06363677623
7762-10	10 mL	100	063636877620
7763-03	30 mL	25	06363677630
7763-10	30 mL	100	063636877637
7764-06	100 mL	25	06363677647
7765-03	50 mL	25	063636776503



Clear



### Medicine Vials

- Translucent polyethylene amber vials provide visibility
- Compatible with child-resistant or snap caps (see options below)
- When closed with the Child Resistant Caps, vials pass both child resistant and senior friendly protocol tests
- Use with either caps to meet USP31/NF26 requirements
- Vials and caps pass USP671 Moisture Permeation tests

Item #	Description	Vial Size/Compatible with Vial	Qty	UPC
5725	Medicine Vial without Caps	33 mL (9 dram)	475	063636700096
5726	Medicine Vial without Caps	48 mL (13 dram)	325	70610813000
5727	Medicine Vial without Caps	60 mL (16 dram)	270	70610700164
5728	Medicine Vial without Caps	73 mL (20 dram)	200	70610700201
5729	Medicine Vial without Caps	110 mL (30 dram)	140	70610700300
5730	Medicine Vial without Caps	148 mL (40 dram)	110	70610700409
5731	<b>A</b> Medicine Vial without Caps	220 mL (60 dram)	70	70610700607
5732	Child Resistant Caps	33 mL (9 dram)	250	70610809003
5733	Child Resistant Caps	48, 60 mL (13, 16 dram)	200	70610813000
5734	<b>B</b> Child Resistant Caps	73 mL (20 dram)	150	70610800208
5735	Child Resistant Caps	110, 148, 200 mL (30, 40, 60 dram)	100	70610830007
5736	Snap Caps	33 mL (9 dram)	300	063636757366
5737	Snap Caps	48, 60 mL (13, 16 dram)	200	063636757373
5738	Snap Caps	73 mL (20 dram)	150	063636757380
5739	<b>C</b> Snap Caps	110, 148, 200 mL (30, 40, 60 dram)	100	063636757397
572532	<b>D</b> Medicine Vial with Child Resistant Cap Attached	33 mL (9 dram)	100	063636725327
572633	Medicine Vial with Child Resistant Cap Attached	48 mL (13 dram)	100	063636726331
572733	Medicine Vial with Child Resistant Cap Attached	60 mL (16 dram)	100	063636727338
572834	Medicine Vial with Child Resistant Cap Attached	73 mL (20 dram)	100	063636828349
572935	Medicine Vial with Child Resistant Cap Attached	110 mL (30 dram)	100	063636729356
573035	Medicine Vial with Child Resistant Cap Attached	148 mL (40 dram)	100	063636730352
573135	Medicine Vial with Child Resistant Cap Attached	220 mL (60 dram)	100	063636731359
572536	<b>E</b> Medicine Vial with Snap Cap Attached	33 mL (9 dram)	100	063636725365
572637	Medicine Vial with Snap Cap Attached	48 mL (13 dram)	100	063636726379
572737	Medicine Vial with Snap Cap Attached	60 mL (16 dram)	100	063636727376
572838	Medicine Vial with Snap Cap Attached	73 mL (20 dram)	100	063636728380
572939	Medicine Vial with Snap Cap Attached	110 mL (30 dram)	100	063636729394
573039	Medicine Vial with Snap Cap Attached	148 mL (40 dram)	100	063636830397
573139	Medicine Vial with Snap Cap Attached	220 mL (60 dram)	100	063636731397

Check out our vial seals on pages 55 & 56



18299



18298



7866



7867



7887

### Multi-Purpose Vial Holder

- Clear, acrylic, multi-purpose vial holder
- Ideal for transporting laboratory samples and pharmacy prescriptions
- Rack has 14 holes measuring 1" and 1 1/8"
- Holder measures: 11 3/4" W x 1 7/16" H x 3" D

Item #	UPC
18536 <b>A</b>	063636185367



### Easy Read Vial Stands & Grippers

- Silicone grippers hold vials, tubes, and syringes at an angle so labels are easy to read
- Angled stands fit neatly inside crash cart boxes
- Stands can be mounted or placed on countertops for easy access
- Small (1/3 length) measures: 6 3/8" W x 1 5/16" H x 2 3/4" D; stand fits crash cart box # 3150
- Medium (1/2 length) measures: 9 7/8" W x 1 5/16" H x 2 13/16" D; stand fits crash cart box # 3131
- Large (full length) measures: 21 1/8" W x 1 5/16" H x 2 3/4" D; stand fits crash cart box # 1814

Item #	Description	Qty	UPC
18832 <b>B</b>	Small Vial Stand And Gripper Set	1	063636188320
18833 <b>C</b>	Medium Vial Stand And Gripper Set	1	063636188337
18834 <b>D</b>	Large Vial Stand And Gripper Set	1	063636188344
18835 <b>E</b>	Small Easy Read Vial Gripper	5	063636188351
18836	Medium Easy Read Vial Gripper	5	063636188368
18837	Small Easy Read Vial Stand	1	063636188375
18838	Medium Easy Read Vial Stand	1	063636188382
18839	Large Easy Read Vial Stand	1	063636188399



**Silicone Grippers** hold vials, tubes & syringes at an angle so labels are easy to read. Small Grippers are ideal for 13 mm caps; Medium Grippers are ideal for 20 mm caps.

### Spray Bottles

- Bottle and atomizer tip with dip tube and screw-on lid.
- Material - Polyethylene bottles

Item #	Size	Qty	UPC
7701 <b>A</b>	15 mL	12	063636777012
7702	15 mL	144	063636777029



### Metered Pump Nasal Spray Bottle

- Controlled Dispensing - Delivers 0.1cc per pump for a consistent dose.
- Material - Polyethylene bottles

Item #	Capacity	Qty	UPC
10271 <b>B</b>	1 oz	12	063636802714
10272	2 oz.	12	063636102722



### Sterile Dropper Bottles

- Sterility Assurance - Ideal for the preparation of sterile ophthalmic solutions. Bottle exterior is sterile until the package is opened; the inside is sterile until the cap is removed.
- All-in-One System - Includes snap-in dropper tips and screw on caps.
- Controlled Dispensing - Releases approximately 42uL per drop and the dispensing tolerance is +/- 5uL

Item #	Size	Amount dispensed per drop	Qty	UPC
7780 <b>C</b>	3 mL	0.023 mL	12	063636777807
7780-02	3 mL	0.023 mL	2	063636877804
7782	7 mL	0.035 mL	12	063636777821
7782-01	7 mL	0.035 mL	1	063636877828
7784	15 mL	0.035 mL	12	063636777845
7784-01	15 mL	0.035 mL	1	063636877842
7786	30 mL	0.035 mL	12	063636777869
7786-01	30 mL	0.035 mL	1	063636877866



### Wash Bottle

- Wide mouth for fast, easy filling
- Bottle and tube molded in one piece to prevent leaking
- Contents can be dispensed without tipping or shaking
- Made of LDPE

Item #	Description	Qty	UPC
70125 <b>D</b>	125 mL	1	063636801250
70250	250 mL	1	063636702502
70500 <b>E</b>	500 mL	1	063636705008





### Plastic Cylinder Bottles & Accessories

- Use for mixing, sampling, storing and dispensing
- Made of durable HDPE
- Caps sold separately

Item #	Description	Qty.	UPC
10407 <b>A</b>	100 mL Cylinder Plastic Bottles	50	063636704070
10408	250 mL Cylinder Plastic Bottles	54	063636704087
10409 <b>B</b>	500 mL Cylinder Plastic Bottles	28	063636704094
10410	1000 mL Cylinder Plastic Bottles	60	063636704100
10411	Screw Cap for Plastic Cylinder Bottles	100	063636704117
10412 <b>C</b>	Child Resistant Screw Cap for Plastic Cylinder Bottles	100	063636704124
10413 <b>D</b>	Flip Top Cap for Plastic Cylinder Bottles	100	063636704131
10414 <b>E</b>	Spray Pump for Plastic Cylinder Bottles	50	063636704148

### Packer Bottles with Pressure Seal Liners

- All-in-one packaging solution saves users from purchasing and storing bulk items separately.
- Caps feature a built-in liner that seals to the bottle without the need for special equipment
- Amber HDPE bottle protects light-sensitive contents
- 100 per package

Item #	Description	Colour	Size	UPC
20826A <b>F</b>	Packer Bottles & Threaded Caps with Pressure Seal Liners	Amber	15ml	063636208264
20826N <b>G</b>	Packer Bottles & Threaded Caps with Pressure Seal Liners	Natural	15ml	063636208226
20827A	Packer Bottles & Threaded Caps with Pressure Seal Liners	Amber	30ml	063636208271
20827N	Packer Bottles & Threaded Caps with Pressure Seal Liners	Natural	30ml	063636208776
20829A	Packer Bottles & Child Resistant Caps w/ Pressure Seal Liners	Amber	15ml	063636208295
20829N	Packer Bottles & Child Resistant Caps w/ Pressure Seal Liners	Natural	15ml	063636208998
20830A	Packer Bottles & Child Resistant Caps w/ Pressure Seal Liners	Amber	30ml	063636208301
20830N	Packer Bottles & Child Resistant Caps w/ Pressure Seal Liners	Natural	30ml	063636208332

### Fretwell's Triangle

- Count regular shaped tablets with absolute accuracy and speed
- Tablets glide easily on the stainless steel triangle
- Easy to clean

Item #	UPC
FT1 <b>A</b>	063636886202

### Tablet Counters

- Plastic pill counting tray with clear lip handle and two corner spouts
- Effective way to keep organized with pill counting
- Includes plastic spatula to aid counting and transferring pills
- Recommended for right-handed users
- Measures: 3 1/2 x 21 x 16 cm

Item #	UPC
D-50 <b>B</b>	063636050306

### Ergonomic Tablet Counters

- Includes spatula with ergonomic grip for easy handling and docking slot
- Designed to provide stability while counting tablets
- Deep blue colour allows pills and powder traces to contrast with tray
- Measures: 7 3/4"W x 6 1/8"H x 1 3/8"D

Item #	Description	UPC
7147	Right-Handed	063636771478
7148 <b>C</b>	Left-Handed	063636771485

### Ambidextrous Tablet Counter

- Polyethylene pill counting tray for left or right handed users
- Spatula included
- Chute has a hinged cover for easy filling
- Measures: 7 3/4" x 6 1/4" x 1 1/2"

Item #	Description	UPC
12261 <b>D</b>	Left or Right Handed	063636122614



### Test Tube Racks

- Safe Transport - Keeps tubes size 5-10 mL upright to reduce the risk for spills and the need for repeat testing
- Easy to Clean - Autoclavable; reduces the risk for cross-contamination.

Item #	Description	Count	UPC
19974	<b>A</b> Test Tube Rack, Full size, 13 mm	72	063636199746
19975	Test Tube Rack, Full size, 16 mm	72	063636199753
19976	<b>B</b> Test Tube Rack, Half size, 13 mm	36	063636199760
19977	Test Tube Rack, Half size, 16 mm	36	063636199777

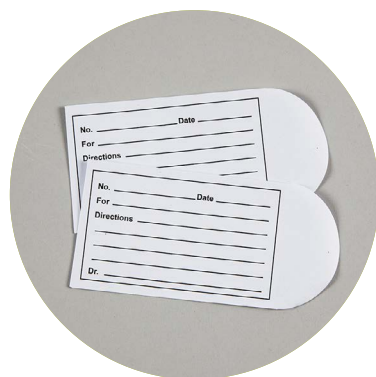
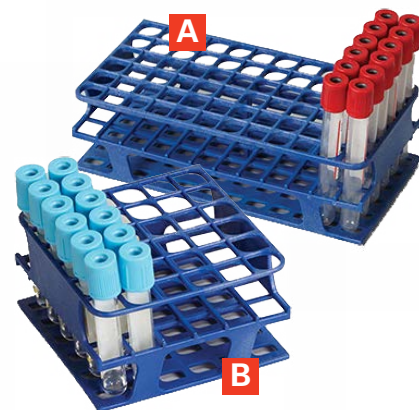

### Medication Envelope

- Quick and simple way to package and dispense medication prepared in small quantities
- Write-on area for patient information and instructions
- Made of white paper
- Measures: 2 1/4 x 3 1/2"

Item #	Qty	UPC
8020	250	063636780203

### Stainless Steel Trays

- Heavy duty
- Stainless steel trays are easy to clean, disinfect and sterilize
- Versatile - Heavy-gauge Stainless Steel tray can be used as a processing, medical supply or pass-through tray to the cleanroom
- Seamless Interior - Non-corrosive tray has open corners and easy-grip handles and nests when empty.

Item #	Dimensions (W x H x D)	Gauge	UPC
18779	<b>A</b> 11.68 x 2.06 x 6.375"	18	063636187798
18665	<b>B</b> 14.93 x 2.25 x 9.18"	18	063636186654
18783	<b>C</b> 12 x 0.5 x 9"	18	063636187835
20252	<b>D</b> 20.75 x 4 x 12.75"	24	063636202521
19308	<b>E</b> 10 x 0.75 x 6.5"	24	063636193089
20253	<b>F</b> 13.625 x 0.62 x 9.75"	24	063636202538
20257	<b>G</b> 12.25 x 2.125 x 7.625"	24	063636202576



### AkroBins

- Durable and long-lasting AkroBins are the industry standard for plastic storage bins
- Heavy-duty, sturdy, one-piece construction is water, rust and corrosion-proof
- Many great organization options are available - stack bins, hang on racks, wall panels, louvered panels, or use on mobile carts
- Reinforced ribs prevent bins from spreading or losing shape
- Large front label slot allows for labelling and relabelling system.
- Take advantage of colour options available to create a colour-coded organization system to control inventory
- Ideal for Kanban visual organization systems and 5S Lean initiatives
- Customize organization system to meet your unique needs - select from standard size bins, super-size bins, bin dividers, clear or amber lids, and many hanging organization strategies

Item #	Outside Dimensions			Capacity (lbs.)	Qty	UPC
	Length	Width	Height			
1400	5 3/8"	4 1/8"	3"	10	24	063636714000
1401	10 7/8"	5 1/8"	4"	30	12	063636714017
1403	14 3/4"	5 1/2"	5"	60	12	063636814038
1405	7 3/8"	4 1/8"	3"	10	24	063636714055
1410	10 7/8"	5 1/2"	5"	30	12	063636814106
1412	10 7/8"	11"	5"	60	6	063636714123
1413	10 3/4"	8 1/4"	7"	60	6	063636814137
1415	14 3/4"	8 1/4"	7"	60	12	063636714154
1417	10 7/8"	16 1/2"	5"	60	6	063636714178
1420	14 3/4"	16 1/2"	7"	75	6	063636714208
1434	18"	8 1/4"	9"	75	6	063636714345
1438	18"	16 1/2"	11"	75	3	063636714383

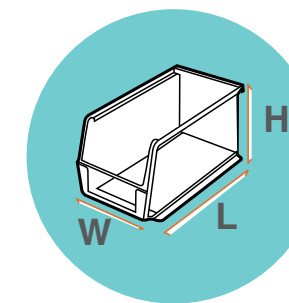

Refer to this outside measurement diagram for all AkroBins® and Insight bins by Akro-Mils®.



Amber lids are ideal for storing light-sensitive medication or IV's

### Super Tough Bins with Clear or Amber Lids

- Select from clear or amber lids, attached or sold separately
- Shield Supplies: Transparent lids keep contents dust-free and protected.
- Easy Content ID: Label slots hold fanfold, roll or laser labels
- Compatible - Waterproof, oil and chemical resistant. Lids keep contents protected
- Bins with lids can still be stacked (however lids cannot be opened when stacked)
- Specify colour when ordering

Item #	Description	Lid Colour	Fits Akro Bin	UPC
1672	Bin with Lid	Clear	#1400	063636167219
1673	Bin with Lid	Clear	#1405	063636167318
1676	Bin with Lid	Clear	#1410	063636167615
1558-01	Bin with Lid	Amber	#1410	063636155803
1555	Bin with Lid	Clear	#1420	063636156114
1556	Bin with Lid	Amber	#1420	063636155612

### Dividers for AkroBins

- Divides bin front to back
- Material: Made of industrial grade polymers
- 6 dividers per package

Item #	Fits Bin Number(s)	Colour	UPC
1931	1400	Black	063636719319
1933	1405	Black	063636719333
1935	1410, 1412	Black	063636719357
1936	1413	Black	063636719364
1937	1415, 1420	Black	063636719371
1968	1401	Clear	063636719685
1973-01	1403	Clear	063636719739



### Super-sized AkroBins

- Large size conducive for large, heavy items
- Sturdy - Reinforced sides keep bins from spreading.
- Weight Capacity - 60 - 75 lbs.
- Available in ● red, ● yellow or ● blue - please specify colour when ordering
- **Note:** Bins can't be hung from panels or rails.

Item #		Outside Dimensions			Capacity (lbs.)	Qty	UPC
		Length	Width	Height			
1404	A	20"	12 <sup>3</sup> / <sub>8</sub> "	6"	60	4	063636814045
1406		20"	12 <sup>3</sup> / <sub>8</sub> "	8"	60	3	063636814069
1407	B	20"	12 <sup>3</sup> / <sub>8</sub> "	12"	75	2	063636814076
1408	C	20"	18 <sup>3</sup> / <sub>8</sub> "	12"	75	1	063636814083
1409		29 <sup>1</sup> / <sub>4</sub> "	18 <sup>3</sup> / <sub>8</sub> "	12"	75	1	063636814090



### Shelf Bins

- Fits standard 12", 18" and 24" shelving (see length below)
- Customize to fit organization needs using bin dividers or bin cups (sold separately)
- Durable polypropylene construction allows Shelf Bins to be fully loaded without bulging or cracking
- Waterproof one-piece construction is unaffected by grease or oil
- Molded label holder for identifying contents
- **Note:** Bins are not made for stacking

Item #		Outside Dimensions (L x W x H)	Case Qty	Small/Large bin cups fit per bin	Divider Item #	UPC
1435	A	11 <sup>5</sup> / <sub>8</sub> x 2 <sup>3</sup> / <sub>4</sub> x 4"	24	3/-	-	063636714352
1440		11 <sup>5</sup> / <sub>8</sub> x 4 <sup>1</sup> / <sub>8</sub> x 4"	24	5/2	1941 (7)	063636714406
1445	B	11 <sup>5</sup> / <sub>8</sub> x 6 <sup>5</sup> / <sub>8</sub> x 4"	12	9/2	1943 (7)	063636714451
1447		11 <sup>5</sup> / <sub>8</sub> x 8 <sup>3</sup> / <sub>8</sub> x 4"	12	11/4	1947 (7)	063636714475
1448		11 <sup>5</sup> / <sub>8</sub> x 11 <sup>1</sup> / <sub>8</sub> x 4"	12	15/6	1948 (7)	063636714482
1450		17 <sup>7</sup> / <sub>8</sub> x 4 <sup>1</sup> / <sub>8</sub> x 4"	12	8/3	1941 (7)	063636714505
1455		17 <sup>7</sup> / <sub>8</sub> x 6 <sup>5</sup> / <sub>8</sub> x 4"	12	15/6	1943 (7)	063636714550
1457		16 <sup>1</sup> / <sub>2</sub> x 7 <sup>1</sup> / <sub>8</sub> x 4"	12	15/6	1947 (7)	063636714574
1456		16 <sup>1</sup> / <sub>2</sub> x 11 <sup>1</sup> / <sub>8</sub> x 4"	12	25/12	1948 (7)	063636714567
1451	C	22 <sup>1</sup> / <sub>8</sub> x 4 <sup>1</sup> / <sub>8</sub> x 4"	12	11/4	1941 (7)	063636714512
1458		23 <sup>5</sup> / <sub>8</sub> x 6 <sup>5</sup> / <sub>8</sub> x 4"	6	21/8	1943 (7)	063636714581
1459		23 <sup>5</sup> / <sub>8</sub> x 8 <sup>3</sup> / <sub>8</sub> x 4"	6	25/8	1947 (7)	063636714598
1454		23 <sup>5</sup> / <sub>8</sub> x 11 <sup>1</sup> / <sub>8</sub> x 4"	6	35/16	1948 (7)	063636714543

### Shelf Bin Dividers

- Polypropylene dividers create compartments within Shelf Bins
- Each bin can hold up to 7 dividers to create 8 compartments (except for item #1435, not compatible with dividers)
- Six dividers per pack

Item #		Colour	Width	Fits Shelf Bin #	UPC
1941	D	Black	4"	1440, 1450 and 1451	063636719418
1942-01		Clear	4"	1440, 1450 and 1451	0636367194215
1943		Black	6"	1445, 1455 and 1458	063636719432
1947		Black	8"	1447, 1457 and 1459	063636719470
1948		Black	11"	1448, 1456 and 1454	063636719487

### Bin Cups (for Shelf Bins)

- Use to keep small parts separated and organized within Shelf Bins
- White, made of industrial grade polymers

Item #		Outside Dimensions (W x H x D)	Qty	UPC
1949	E	3 <sup>1</sup> / <sub>4</sub> x 3 x 2"	48	063636719494
1950		5 x 3 x 2 <sup>3</sup> / <sub>4</sub> "	24	063636719500

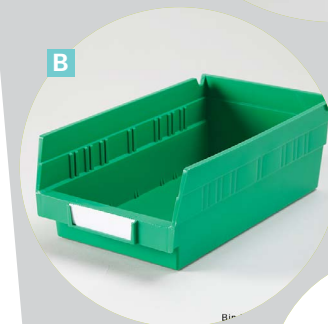

## Hanging Rail and Louvered Panels

- Space Saving - Bin Rails allow users to reclaim valuable floor space by hanging nearly an entire wall full of filled bins in one convenient location.
- Quick Access - Use to store orders awaiting delivery, dispensing supplies, at nursing stations, in supply rooms, for convenient storage of IV and treatment supplies, etc.
- Beige powder-coated finish
- Ideal for use with AkroBins®, Insight Bins, and Hanging Wire Bins
- **Note:** Bins are sold separately

Item #	Description	Dimensions (W x H)	UPC
1433	<b>A</b> Rail	48 x 3"	063636714338
1423	Louvered Bin Panel (XS)	18 x 19"	063636814236
1425	Louvered Bin Panel (S)	35 <sup>3</sup> / <sub>4</sub> x 19"	063636714253
18562	<b>B</b> Louvered Bin Panel (M)	18 x 61"	063636185626
17484	Louvered Bin Panel (L)	36 x 61"	063636174842
18563	<b>C</b> Louvered Bin Panel (XL)	48 x 61"	063636185633

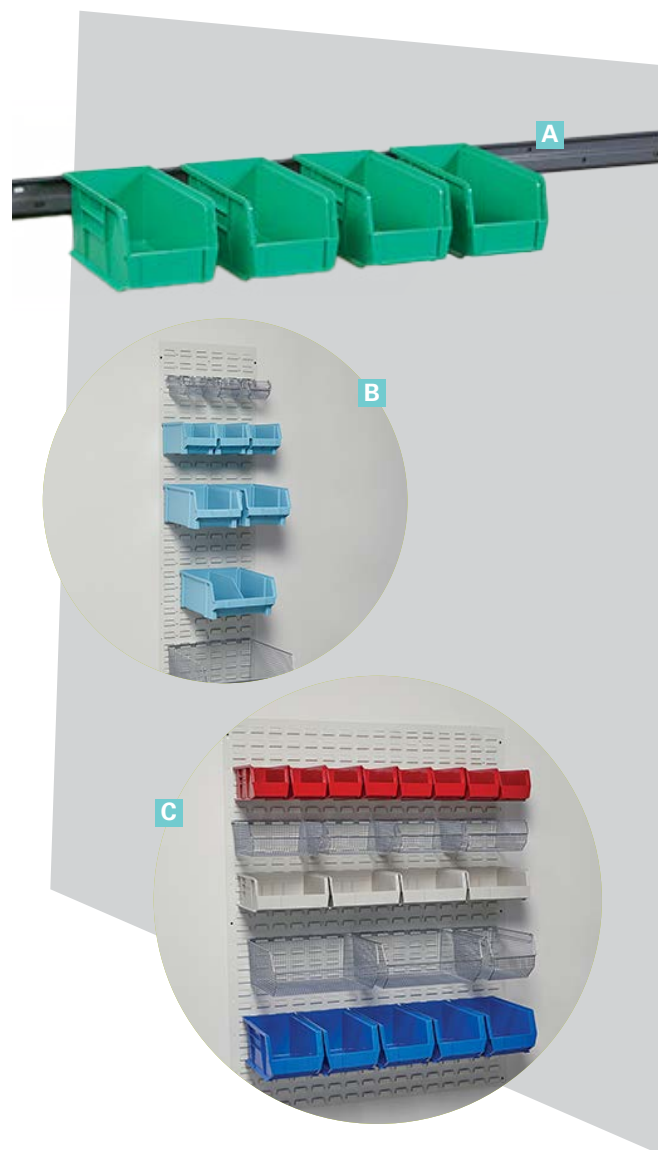

Half Size Bins



Full Size Bins

## Unit Dose Bins

- Ideal for efficient dispensing and inventory control
- Fits 12" deep shelves
- Half-size can stack 2 deep on 12" shelves, convenient for tight spaces
- Back panel hanging lip can hang from panels and carts
- Made of durable polyethylene copolymer
- Available in ○ clear, ● grey, ● ivory, ● light blue, ● red or ● yellow - please specify colour when ordering

Item #	Size	Outside Dimensions L x W x H	Case Qty	UPC
5305-01	Full Size	11 <sup>7</sup> / <sub>8</sub> x 3 x 2 <sup>3</sup> / <sub>4</sub> "	1	-
5310	Full Size	11 <sup>7</sup> / <sub>8</sub> x 6 x 2 <sup>3</sup> / <sub>4</sub> "	12	063636753108
5301-01	Half Size	6 <sup>9</sup> / <sub>16</sub> x 2 x 2 <sup>3</sup> / <sub>4</sub> "	1	063636530105
5302-01	Half Size	6 <sup>9</sup> / <sub>16</sub> x 3 x 2 <sup>3</sup> / <sub>4</sub> "	1	063636530204

## Deluxe Shelf Caddies

- Less Contamination - Made of non-shedding plastic to reduce the risk of contamination.
- Disposable - Offers a cost effective alternative to heavy-duty plastic storage containers.
- Lightweight & Convenient - Durable design is lightweight yet sturdy to prevent stacked bins from collapsing. Ideal option for supply storage on pharmacy carousels.
- Compact Storage - Ships flat

Item #		Outside Dimensions (L x W x H)	Qty	UPC
9070	<b>A</b>	12 x 2 x 4"	25	063636790707
9071		12 x 4 x 4"	25	790714063636
9072	<b>B</b>	12 x 6 x 4"	25	063636790721
9073		12 x 8 x 4"	25	063636790738
9074		18 x 4 x 4"	25	063636790745
9075		18 x 6 x 4"	25	063636790752
9076	<b>C</b>	18 x 8 x 4"	25	063636790769



## Cardboard Shelf Caddies

- Ideal for disposable use (ie: infection control areas, hazardous product storage, etc.)
- Budget Friendly - Our most economical bins ship flat for reduced shipping costs.
- Convenient - Write-on surface for quick labeling.
- Disposable - Cardboard bins can be recycled. When a bin is dirty, simply replace it. No need to clean!
- Compact Storage - Ships flat

Item #		Outside Dimensions (L x W x H)	Qty	UPC
7458		12 x 2 x 4 <sup>1</sup> / <sub>2</sub> "	50	063636774585
7460	<b>D</b>	12 x 4 x 4 <sup>1</sup> / <sub>2</sub> "	50	063636774608
7465		12 x 6 x 4 <sup>1</sup> / <sub>2</sub> "	50	063636774653
7475	<b>E</b>	12 x 12 x 4 <sup>1</sup> / <sub>2</sub> "	50	063636774752



### Waterloo® Locking Cassettes

- Enclosed to protect bins from dust and contaminants
- Trays between tiers protect against spillage and medication migration
- Lift-handle on top of the cassette for easy handling, top handle lays flat for stacking
- Multi-tier cassettes and three drawer sizes allows for customization depending on organization needs - bins, dividers and labels sold separately, see below
- Made of a combination of steel and aluminum
- Independently lockable

Item #	# of Tiers	Outside Dimensions (W x H x D)	Weight	UPC
1343	A	2	20 <sup>7</sup> / <sub>16</sub> X 7 <sup>13</sup> / <sub>16</sub> X 10"	16 lbs. 063636813437
1344	B	3	20 <sup>7</sup> / <sub>16</sub> X 10 <sup>9</sup> / <sub>4</sub> X 10"	16 lbs. 063636813444
1346	C	4	20 <sup>7</sup> / <sub>16</sub> X 13 <sup>5</sup> / <sub>8</sub> X 10"	19 lbs. 063636713461

### Bins for Waterloo® Locking Cassettes

- Sort Supplies - Bins are ideal for efficient dispensing and inventory control
- Easy Content ID - Bin Fronts have label slots for quick supply identification. Ideal for efficient dispensing and inventory control of strips, orals, ampules, vials, and other small items
- One plastic label protector included with each bin
- Colour: Light blue
- Ideal for storage in Waterloo® locking cassettes (above)

Item #	Outside Dimensions (W x H x D)	Compatibility with			Qty	UPC
		2-Tier #1343	3-Tier #1344	4-Tier #1346		
1321-01	9 <sup>3</sup> / <sub>4</sub> X 3 X 2 <sup>1</sup> / <sub>2</sub> "	12	18	24	1	063636013219
1322-01	D 9 <sup>3</sup> / <sub>4</sub> X 4 <sup>1</sup> / <sub>2</sub> X 2 <sup>1</sup> / <sub>2</sub> "	8	12	16	1	063636132217

### Dividers for Waterloo® Locking Cassettes

- Organize bins with dividers placed side to side or front to back
- White in colour
- 6 per package

Item #	Description	Direction	Bin Compatibility	UPC
1916	E Long Divider	Front to back	1321,1322, 1323	063636719166
1912	F Short Divider	Side to side	1321	063636719128

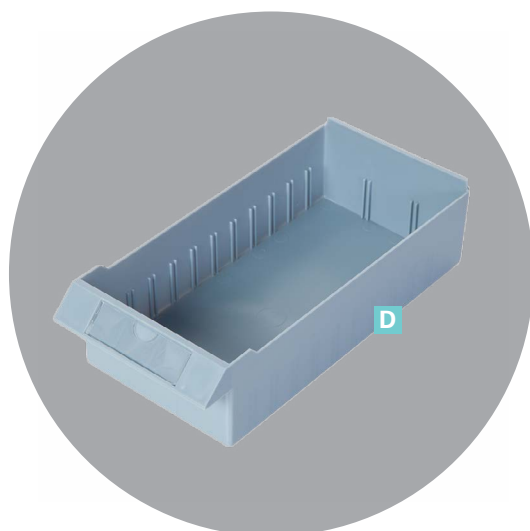

### Cassettes

- Keep multiple medications and supplies organized at nursing stations, offices, storage rooms and clinics for quick access.
- Made of lightweight powder-coated steel. The bins are made of hi-impact polystyrene.
- Color Options - Available in Blue or Gray. Specify color when ordering.
- Dividers for drawers are sold separately, see below (fits side to side, 25 per package)

Item #	Number of Bins Included	Bin Dimensions (W x H x D)	UPC
1340	A 28 (Item # 1300)	2 <sup>3</sup> / <sub>16</sub> X 2 <sup>1</sup> / <sub>8</sub> X 10 <sup>9</sup> / <sub>16</sub> "	063636713409
1345	B 20 (Item # 1305)	3 <sup>1</sup> / <sub>8</sub> X 2 <sup>1</sup> / <sub>8</sub> X 10 <sup>9</sup> / <sub>16</sub> "	063636713454
1352	C 9 (Item # 1320)	5 <sup>3</sup> / <sub>16</sub> X 3 X 10 <sup>9</sup> / <sub>16</sub> "	063636713522

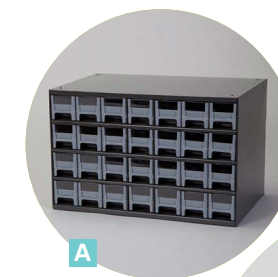

### Additional Bins for Cassettes

- Quick Access - Bins are ideal for patient medications and small supply storage. These bins are replacements for Cassettes (above)
- Protect Labels - Bin window included with each bin. Replacement windows are also available.
- Identify Contents - Bin fronts have label slots for quick supply identification. Cardstock, fan-folded labels sold separately.
- Sort Contents - Dividers are available to divide bins from side-to-side.

Item #	Outside Dimensions (W x H x D)	Bin Qty	Use with Divider # (25 per package)	UPC
1300	D 2 <sup>3</sup> / <sub>16</sub> X 2 <sup>1</sup> / <sub>8</sub> X 10 <sup>9</sup> / <sub>16</sub> "	1	1907	063636130008
1305-01	3 <sup>1</sup> / <sub>8</sub> X 2 <sup>1</sup> / <sub>8</sub> X 10 <sup>9</sup> / <sub>16</sub> "	1	1909	063636013059
1308-01	4 X 2 <sup>1</sup> / <sub>8</sub> X 10 <sup>9</sup> / <sub>16</sub> "	1	1911	063636413019
1315-01	E 3 <sup>3</sup> / <sub>16</sub> X 3 X 10 <sup>9</sup> / <sub>16</sub> "	1	1915	063636013158
1320-01	F 5 <sup>3</sup> / <sub>16</sub> X 3 X 10 <sup>9</sup> / <sub>16</sub> "	1	1917	063636013202
1320	F 5 <sup>3</sup> / <sub>16</sub> X 3 X 10 <sup>9</sup> / <sub>16</sub> "	15	1917	063636013202

### Plastic Floor Stock Cassettes

- Black rugged, high-impact polystyrene frame resists damage in shipping and storage
- Drawers are molded of semi-clear polypropylene
- Front-to-back dividers are included and are molded into cabinet back; simply cut them out of the frame to remove
- Recessed tray tops allow cassettes to stack

Item #	Outside Dimensions (W x H x D)	Drawers per cabinet	UPC
1368	20 X 15 <sup>1</sup> / <sub>2</sub> X 6 <sup>3</sup> / <sub>8</sub> "	12 Large, 32 Small	063636713683
1365	G 10 <sup>1</sup> / <sub>2</sub> X 8 <sup>1</sup> / <sub>2</sub> X 6 <sup>3</sup> / <sub>8</sub> "	16 Small	063636713652

## Divider Boxes

- Stackable - recessed stacking ledges protect contents
- Injection molded of tough and durable polypropylene plastic for strength and uniform wall thickness
- Resistant to most solvents, chemicals, stress cracks and is autoclavable at 121°C for two minutes
- Specify colour when ordering (blue, grey, red, semi-clear, or light-blue)
- Accessories are available separately: lids (below), security seals, or contact us for dividers, and label holders
- Also available with pre-drilled holes for security seals - contact us for details

Item #	Outside Dimensions (L x W x H)	Colour	UPC
1700	A 10 <sup>7</sup> / <sub>8</sub> x 8 <sup>1</sup> / <sub>4</sub> x 5"	●	063636717001
1705	16 <sup>1</sup> / <sub>2</sub> x 10 <sup>7</sup> / <sub>8</sub> x 6"	● ● ●	063636717056
1710	16 <sup>1</sup> / <sub>2</sub> x 10 <sup>7</sup> / <sub>8</sub> x 8"	● ●	063636717100
1715	22 <sup>3</sup> / <sub>8</sub> x 17 <sup>3</sup> / <sub>8</sub> x 8"	● ● ●	063636717155
1723	B 16 <sup>1</sup> / <sub>2</sub> x 10 <sup>7</sup> / <sub>8</sub> x 3 <sup>1</sup> / <sub>2</sub> "	● ● ●	063636717230
1724	C 10 <sup>7</sup> / <sub>8</sub> x 8 <sup>1</sup> / <sub>4</sub> x 2 <sup>1</sup> / <sub>2</sub> "	● ●	063636887247
1725	10 <sup>7</sup> / <sub>8</sub> x 8 <sup>1</sup> / <sub>4</sub> x 3 <sup>1</sup> / <sub>2</sub> "	● ● ●	063636717254
1891	16 <sup>1</sup> / <sub>2</sub> x 10 <sup>7</sup> / <sub>8</sub> x 4"	● ●	063636718916
1892	22 <sup>3</sup> / <sub>8</sub> x 17 <sup>3</sup> / <sub>8</sub> x 10"	● ●	063636718923
1893	22 <sup>3</sup> / <sub>8</sub> x 17 <sup>3</sup> / <sub>8</sub> x 4"	● ● ●	063636718930
1894	22 <sup>3</sup> / <sub>8</sub> x 17 <sup>3</sup> / <sub>8</sub> x 6"	● ● ●	063636718947

## Divider Box Accessories

- Lids include lift-holes providing an area to secure the box with security seals (sold separately)
- Semi-clear snap-on lids fit over the top edges of the box
- Clear deluxe lids fit on inside rim of boxes

Item #	Lid Type	Fits Box #'s	UPC
1732	D Deluxe Lid	1893, 1894, 1715, 1892	063636717322

## Locking Wall Box with Digital Lock

- Clear wall-mount locking storage boxes keep critical medications and loose supplies visible and secure in a consistent location.
- Includes Keyless Entry Digital Lock, which uses a four-digit code and offers immediate access control with three levels of user admittance (no audit trail).
- 1/8" thick acrylic plastic boxes.
- Boxes have pre-drilled mounting holes
- Custom box sizes available. Contact us to learn more!

Item #	Outside Dimensions (W x H x D)	UPC
18557	E 11 x 3 x 2 <sup>3</sup> / <sub>4</sub> "	063636185572



## Tote Boxes

- Tough, versatile plastic totes stack and nest to provide efficient supply storage and transportation efficiency
- Totes will stack with or without lids and can be turned 180° to nest when empty for maximum storage capacity
- Ribs on sides help prevent jamming when nested
- Can withstand temperature ranges from -12°C to 121°C (-10°F to 250°F)
- Optional lids available (sold separately, see options below) and can be secured with security seals (see pages 30-31)
- Clear label holders can be attached to the side of the tote for quick supply identification (item #1683)
- Available in ● blue, ● grey and ● red - please specify box and lid colour when ordering

Item #	Outside Dimensions (L x W x H)	Lid Compatibility (Lid Item #)	UPC
1603	A 18 x 11 x 6"	1624	063636816032
1604	18 x 11 x 9"	1624	063636816049
1607	19 <sup>1</sup> / <sub>2</sub> x 13 <sup>1</sup> / <sub>2</sub> x 8"	1627	063636816070
1605	19 <sup>1</sup> / <sub>2</sub> x 15 <sup>1</sup> / <sub>2</sub> x 10"	1626	063636816056
1606	19 <sup>1</sup> / <sub>2</sub> x 15 <sup>1</sup> / <sub>2</sub> x 13"	1626	063636816063
1614	B 23 <sup>1</sup> / <sub>2</sub> x 15 <sup>1</sup> / <sub>2</sub> x 12"	1629	063636816148
1612	23 <sup>1</sup> / <sub>2</sub> x 19 <sup>1</sup> / <sub>2</sub> x 13"	1628	063636816124
1618	C 29 <sup>1</sup> / <sub>2</sub> x 19 <sup>1</sup> / <sub>2</sub> x 15"	1632	063636816186
1638	D Label Holders - Holds 3 x 5" labels	-	063636816384

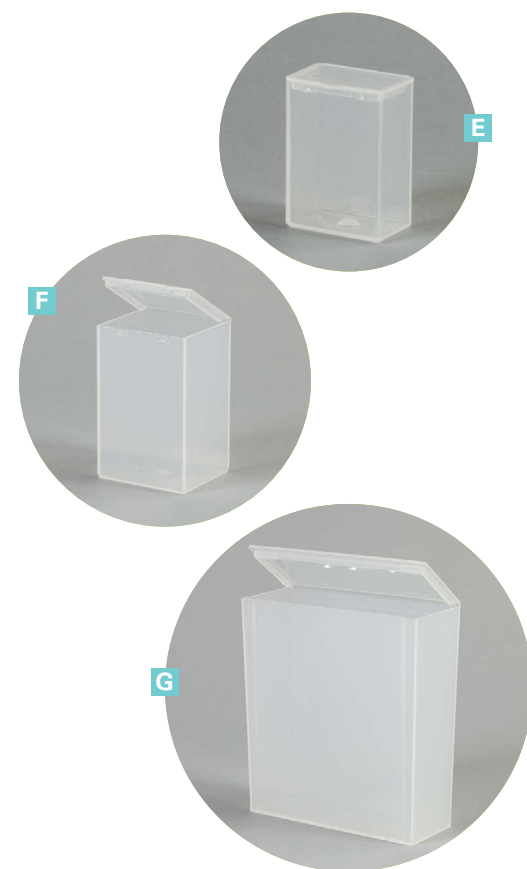

## Flip Top Boxes

- Boxes flip open easily for quick access- no fumbling with awkward closures
- Ideal for packaging and dispensing small quantities of medication
- Made of polypropylene plastic
- Secure with pull-tight seals
- 5 per package

Item #	Colour	Capacity	Outside Dimensions (W x H x D)	UPC
5100	E Clear	4 Dram/15 mL	1 <sup>1</sup> / <sub>8</sub> x 1 <sup>5</sup> / <sub>8</sub> x 1 <sup>11</sup> / <sub>16</sub> "	063636951009
5102	Clear	9 Dram/33 mL	1 <sup>5</sup> / <sub>8</sub> x 2 <sup>1</sup> / <sub>2</sub> x 1 <sup>11</sup> / <sub>16</sub> "	063636751029
5104	F Clear	19 Dram/70 mL	1 <sup>5</sup> / <sub>8</sub> x 2 <sup>1</sup> / <sub>2</sub> x 1 <sup>3</sup> / <sub>8</sub> "	063636751043
5121	Clear	38 Dram/140 mL	3 <sup>3</sup> / <sub>4</sub> x 1 <sup>5</sup> / <sub>8</sub> x 2 <sup>3</sup> / <sub>4</sub> "	063636751210
5106	Clear	42 Dram/155 mL	2 <sup>1</sup> / <sub>8</sub> x 2 <sup>5</sup> / <sub>8</sub> x 2 <sup>3</sup> / <sub>8</sub> "	063636751067
5108	G Clear Tapered	104 Dram/384 mL	4 <sup>1</sup> / <sub>4</sub> x 1 <sup>3</sup> / <sub>4</sub> x 4 <sup>11</sup> / <sub>16</sub> "	063636751081

Removable lids with double latches ensure that lids remain secure & provides a stable, secure stacking surface!



Totes with the same length and width will nest without lids

### Store Totes with Lids

- Combines the ability to stack with the durability and affordability of smart storage and transport totes for supplies
- Features built-in carrying handles for easy lifting and handling
- Reinforced heavy-load bottoms
- Withstand temperature ranges from -40°C to 120°C
- Made of durable polypropylene plastic
- Available in ○ clear or ● grey; specify colour when ordering

Item #	Capacity	Dimensions (L x W x H)	UPC
13200	<b>A</b> 1 Litre	7 <sup>7</sup> / <sub>8</sub> X 6 <sup>11</sup> / <sub>16</sub> X 2"	063636132002
13201	<b>B</b> 2 Litres	7 <sup>7</sup> / <sub>8</sub> X 6 <sup>11</sup> / <sub>16</sub> X 3 <sup>15</sup> / <sub>16</sub> "	063636132019
13202	<b>C</b> 3 Litres	7 <sup>7</sup> / <sub>8</sub> X 6 <sup>11</sup> / <sub>16</sub> X 5 <sup>1</sup> / <sub>2</sub> "	063636132026
13203	8 Litres	13 <sup>3</sup> / <sub>16</sub> X 8 <sup>7</sup> / <sub>8</sub> X 6 <sup>1</sup> / <sub>8</sub> "	063636132033
13204	15 Litres	15 <sup>3</sup> / <sub>4</sub> X 11 <sup>13</sup> / <sub>16</sub> X 7 <sup>1</sup> / <sub>4</sub> "	063636132040
13206	35 Litres	27 <sup>9</sup> / <sub>16</sub> X 15 <sup>9</sup> / <sub>16</sub> X 7 <sup>1</sup> / <sub>8</sub> "	063636132064
13207	50 Litres	19 <sup>11</sup> / <sub>16</sub> X 15 <sup>3</sup> / <sub>8</sub> X 15 <sup>3</sup> / <sub>4</sub> "	063636132071
13208	70 Litres	27 <sup>9</sup> / <sub>16</sub> X 15 <sup>9</sup> / <sub>16</sub> X 15"	063636132088

### Hinged Lid Transfer Boxes

- Attached, hinged lids open and close easily with a tight interlocking fit
- Stack when filled and nest when empty with anti-jamming nesting tabs
- Lids can be sealed with security seals (sold separately)
- Moulded-in handle grips for easy lifting and handling
- Boxes have full length steel hinge pins for durability

Item #	Outside Dimensions (W x H x D)	Colour	UPC
5510	20 <sup>5</sup> / <sub>8</sub> X 13 <sup>1</sup> / <sub>4</sub> X 11 <sup>1</sup> / <sub>2</sub> "	●	063636755102
5515	21 <sup>7</sup> / <sub>8</sub> X 15 <sup>3</sup> / <sub>16</sub> X 9 <sup>1</sup> / <sub>4</sub> "	● ● ●	063636755157
5537	26 <sup>1</sup> / <sub>8</sub> X 12 <sup>3</sup> / <sub>4</sub> X 17"	●	063636755379
5531	11 <sup>3</sup> / <sub>4</sub> X 9 <sup>3</sup> / <sub>4</sub> X 7 <sup>3</sup> / <sub>4</sub> "	● ●	063636755317
5532	<b>D</b> 19 <sup>3</sup> / <sub>4</sub> X 11 <sup>3</sup> / <sub>4</sub> X 7 <sup>1</sup> / <sub>4</sub> "	● ● ●	063636755324
5533	21 <sup>3</sup> / <sub>4</sub> X 12 <sup>7</sup> / <sub>8</sub> X 15 <sup>1</sup> / <sub>16</sub> "	●	063636755331
5534	15 <sup>1</sup> / <sub>8</sub> X 10 <sup>7</sup> / <sub>8</sub> X 9 <sup>3</sup> / <sub>4</sub> "	● ● ●	063636755348
5535	21 <sup>7</sup> / <sub>8</sub> X 15 <sup>3</sup> / <sub>16</sub> X 9 <sup>1</sup> / <sub>4</sub> "	●	063636755355
5536	<b>E</b> 26 <sup>1</sup> / <sub>8</sub> X 12 <sup>3</sup> / <sub>4</sub> X 17"	● ● ●	063636755362
5545	27 <sup>5</sup> / <sub>8</sub> X 20 <sup>5</sup> / <sub>8</sub> X 15 <sup>9</sup> / <sub>16</sub> "	● ● ●	063636755454
5550-01	21 <sup>1</sup> / <sub>2</sub> X 19 X 13"	●	063636755508
5551-01	21 <sup>3</sup> / <sub>4</sub> X 15 <sup>1</sup> / <sub>8</sub> X 13"	● ● ●	063636755515
5552-01	<b>F</b> 21 <sup>1</sup> / <sub>2</sub> X 18 <sup>1</sup> / <sub>2</sub> X 17"	●	063636755522

### Store-Max 8 Inch High Bin

- Oversized: 95% more storage capacity than standard 4"H bins.
- Versatile: Use with 12", 18" and 24"D shelving units.
- Complete Access: Built-in rear notches allow bins to safely tilt out.
- Color Options - Available in Blue and Clear. Specify color when ordering.
- Easy Content ID: Label slot holds Bin Label (7165).
- Sort Contents: Divides bin side-to-side (18945, sold separately) to keep supplies sorted and maximize organization.

Item #	Dimensions (W x H x D)	UPC
18937	6 x 8 x 17"	063636189372



### Stainless Steel Trays

- Heavy-gauge stainless steel tray can be used as a processing tray, medical supply organizing tray or a pass-through tray to the cleanroom
- Ideal for the pharmacy and lab use
- Seamless, non-corrosive metal tray has open corners and easy-grip handles and nests when empty
- View all stainless steel trays on page 32



Item #	Size	Dimensions (W x H x D)	UPC
18779	Small	11 <sup>11</sup> / <sub>16</sub> X 2 <sup>1</sup> / <sub>16</sub> X 6 <sup>3</sup> / <sub>8</sub> "	063636187798
18665	Large	15 X 2 <sup>1</sup> / <sub>4</sub> X 10 <sup>3</sup> / <sub>16</sub> "	063636186654
18783	Shallow	12 X 1 <sup>1</sup> / <sub>2</sub> X 9"	063636187835

### Nest and Stack Totes and Lids

- Totes nest inside each other when empty to save floor and counter space and can be stacked on top of each other when closed with a lid
- Optional dual purpose lids can be used as trays (sold separately)
- Withstand an extreme range in temperature 15°C (60°F) to 121°C (250°F)
- Weight capacity of 500 lbs. (226.8kg)
- Thin wall design and construction give maximum strength while remaining lightweight
- Made of fiberglass-reinforced polyester
- Autoclavable up to 250°C (121°C at 15 lbs./sq. in.)
- Specify colour: ● grey, ● green, ● blue, ● red and ● yellow
- \*Only available in grey

Item #	Outside Dimensions W x D x H	Lid Item #	Bin UPC
5593	9 <sup>7</sup> / <sub>8</sub> X 6 <sup>1</sup> / <sub>4</sub> X 2 <sup>1</sup> / <sub>8</sub> "	5751	063636559311
5594	9 <sup>7</sup> / <sub>8</sub> X 6 <sup>1</sup> / <sub>4</sub> X 4 <sup>1</sup> / <sub>2</sub> "	5751	063636559410
5595*	11 <sup>5</sup> / <sub>16</sub> X 8 <sup>7</sup> / <sub>8</sub> X 4 <sup>1</sup> / <sub>8</sub> "	5752	063636559519
5596*	12 <sup>7</sup> / <sub>16</sub> X 9 <sup>7</sup> / <sub>8</sub> X 2 <sup>1</sup> / <sub>8</sub> "	5753	063636559618



### Mesh Basket

- Compact - Plastic baskets in three sizes provide multiple storage options for organizing vials and other pharmacy supplies. Baskets nest when not in use.
- Smart Design - Mesh construction allows airflow and easy content identification.

Item #	Dimensions (W x H x D)	UPC
19921W <b>A</b>	6 <sup>11</sup> / <sub>16</sub> X 2 <sup>3</sup> / <sub>4</sub> X 9 <sup>13</sup> / <sub>16</sub> "	063636199210



### Tilters® Tilt Front Bins

- Modular bins – stack and customize to fit your storage and organization requirements
- Front opens at a 45 degree angle for easy access
- Clear fronts provide easy visual access to inventory
- Moulded in tough beige or white plastic (specify colour when ordering)

Item #	Overall Dimensions (W x H x D)	Compartment Dimensions (W x H x D)	# of Compartments per unit	UPC
1203A <b>B</b>	23 <sup>5</sup> / <sub>8</sub> X 4 <sup>1</sup> / <sub>2</sub> X 3 <sup>5</sup> / <sub>8</sub> "	3 <sup>1</sup> / <sub>8</sub> X 2 <sup>3</sup> / <sub>4</sub> X 2 <sup>5</sup> / <sub>8</sub> "	6	063636512316
1205E <b>C</b>	23 <sup>5</sup> / <sub>8</sub> X 6 <sup>1</sup> / <sub>2</sub> X 5 <sup>1</sup> / <sub>4</sub> "	4 X 4 <sup>1</sup> / <sub>2</sub> X 3 <sup>3</sup> / <sub>4</sub> "	5	063636120597
1207E <b>D</b>	23 <sup>5</sup> / <sub>8</sub> X 8 <sup>1</sup> / <sub>8</sub> X 6 <sup>5</sup> / <sub>8</sub> "	5 X 5 <sup>1</sup> / <sub>4</sub> X 5"	4	063636012076
1210A <b>E</b>	23 <sup>5</sup> / <sub>8</sub> X 9 <sup>1</sup> / <sub>2</sub> X 7 <sup>3</sup> / <sub>4</sub> "	7 <sup>3</sup> / <sub>4</sub> X 23 <sup>5</sup> / <sub>8</sub> X 9 <sup>1</sup> / <sub>2</sub> "	3	063636512217
1215 <b>F</b>	23 <sup>5</sup> / <sub>8</sub> X 13 <sup>7</sup> / <sub>8</sub> X 11 <sup>3</sup> / <sub>4</sub> "	11 <sup>7</sup> / <sub>8</sub> X 23 <sup>5</sup> / <sub>8</sub> X 13 <sup>7</sup> / <sub>8</sub> "	2	063636012151
1213 <b>G</b>	11 <sup>3</sup> / <sub>16</sub> X 13 <sup>7</sup> / <sub>8</sub> X 11 <sup>3</sup> / <sub>4</sub> "	10 <sup>1</sup> / <sub>2</sub> X 13 <sup>1</sup> / <sub>4</sub> X 8 <sup>1</sup> / <sub>4</sub> "	1	063636012137

### High Alert Insulin Bin

- Includes one "Stop Potential Double Check" label and two "High alert Insulin" labels (additional labels sold separately – contact us for details)
- Distinct appearance differentiates the bin from other supply bins; therefore reducing potential medication errors during storage and dispensing
- Lid and labelling serve as a cue for the healthcare professional to read and verify before using
- Clear lid allows bin contents to remain visible
- Accommodates 10 packs of insulin vials
- Made out of PETG
- Can be cleaned with sterile alcohol 70% spray, Isopropyl Alcohol 99%, and Infection Control Surface Wipes, see page 100-101 for options and details

Item #	Outside Dimensions (W x H x D)	UPC
17261	4 <sup>1</sup> / <sub>8</sub> x 4 x 10 <sup>7</sup> / <sub>8</sub> "	063636172619



### Rx Fill Tray

- Rx fill trays help keep individual prescription components together from arrival at the drug store to the prescription pick up counter
- Trays have easy-grip handles, nest when empty to save space
- Available in blue, clear, green, red, white and yellow - specify colour when ordering

Item #	Outside Dimensions (W x L x H)	UPC
17487	6 <sup>7</sup> / <sub>8</sub> x 10 <sup>1</sup> / <sub>2</sub> x 2 <sup>1</sup> / <sub>2</sub> "	063636717230

### Drawer Organizing Trays

- Organize supplies in carts, cabinets, on counters or use as exchange trays for anesthesia, treatment, medication and crash carts
- Includes dividers (additional dividers sold separately, see items below)
- Made of white high impact polystyrene plastic

Item #	Description	Outside Dimensions (L x W x H)	UPC
12560 <b>A</b>	Tray with Dividers	15 x 10 <sup>3</sup> / <sub>4</sub> x 2"	063636125608
12561 <b>B</b>	Tray with Dividers	15 x 10 <sup>3</sup> / <sub>4</sub> x 3 <sup>1</sup> / <sub>2</sub> "	063636125660
12562	Tray with Dividers	15 x 10 <sup>3</sup> / <sub>4</sub> x 6"	063636125622
12568	Tray Only (no dividers)	15 x 10 <sup>3</sup> / <sub>4</sub> x 2"	063636125684
12569	Tray Only (no dividers)	15 x 10 <sup>3</sup> / <sub>4</sub> x 3 <sup>1</sup> / <sub>2</sub> "	063636125691
12570	Tray Only (no dividers)	15 x 10 <sup>3</sup> / <sub>4</sub> x 6"	063636012571
12564	2" High Dividers, 2 long, 3 short (for #12568)	-	063636125646
12565	3 <sup>1</sup> / <sub>2</sub> " High Dividers, 2 long, 3 short (for #12569)	-	063636125653
12566	6" High Dividers, 2 long, 3 short (for #12570)	-	063636212568





Two deep compartments for organizing supplies when transporting between departments and from floor to floor



Caddy has one pull-out drawer. Drawer contains 12 compartments



Resilient and durable carry caddies have one slide-out drawer. The drawer contains six compartments



This carrier has four large compartments with removable dividers to organize phlebotomy supplies for quick retrieval



Features a set of two economical, disposable, compartmentalized inserts specifically designed for blood collection.

Includes: Sturdy plastic tray comes with its own 16mm test tube rack and two disposable Phlebotomy Tray Inserts

### Carry Caddies

- Use to transport supplies to and from the patient site and provides portable workstations - reduce trips to supply areas
- Resilient and durable carry caddies are made of high density polyethylene plastic
- **Note:** Height measurements below do not include handles

Item #	# of Compartments	Description	Outside Dimensions (W x H x D)	UPC
5228	A 2	Carry Caddy	15 x 4 <sup>7</sup> / <sub>8</sub> x 10 <sup>7</sup> / <sub>8</sub> "	063636752286
5231	B 2	Tote Caddy	18 x 5 <sup>1</sup> / <sub>2</sub> x 14"	063636752316
1828	C 12	Emergency Carry Caddy with Drawer	16 <sup>1</sup> / <sub>2</sub> x 6 <sup>5</sup> / <sub>16</sub> x 10 <sup>1</sup> / <sub>4</sub> "	063636718282
5227	D 6	Carry Caddy with Drawer	15 x 7" x 9 <sup>1</sup> / <sub>4</sub> "	063636752279
10318	E 4	Phlebotomy Supply Carrier with Removable Dividers	16 <sup>1</sup> / <sub>2</sub> x 3 <sup>5</sup> / <sub>16</sub> x 11 <sup>3</sup> / <sub>4</sub> "	063636103187
17465	F 8	Phlebotomy Tray Includes 2 inserts (17746) and 5/8" Tube Rack	16 <sup>7</sup> / <sub>8</sub> x 5 <sup>7</sup> / <sub>8</sub> x 9 <sup>1</sup> / <sub>4</sub> "	063636174651
17466	8	Phlebotomy Tray Inserts for 17465 (8 Compartments)	-	063636174668

Large carrying handle folds flat for stacking

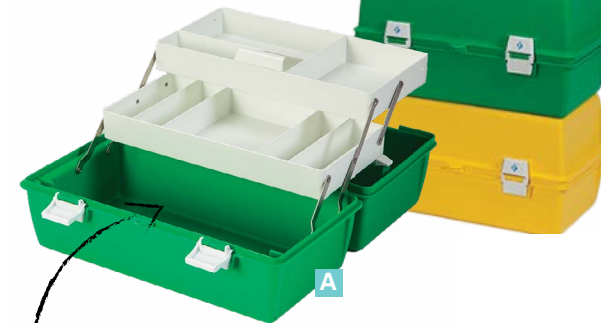

Bottom storage area for storing larger items

Handle folds down flush and box is stackable to save space



A padlock or security seal can be inserted in the security seal eyelets to make them tamper evident



Twin top storage compartments have easy access lids

### Medical Supply Box

- Includes 2 cantilever trays, with 3 compartments on the top, and 5 compartments on the bottom
- Double latch closure ensures lid will stay securely closed while carrying
- Built-in security eyelet accepts security seals and small padlocks to make the box tamper-evident
- Made of durable polypropylene plastic
- Designate a colour for a particular use or department
- Available in blue, green, and yellow - specify colour when ordering

Item #	Dimensions (W x H x D)	UPC
17265	A 17 <sup>5</sup> / <sub>8</sub> x 10 <sup>1</sup> / <sub>4</sub> x 8 <sup>3</sup> / <sub>4</sub> "	063636172657

### Medical Supply Carrying Boxes

- Medical supply box ideal for storage and carrying various medication, patient procedure supplies, medical passes, exchanges, and many other storage uses
- Provides secure stacking on shelves or palettes
- Steel draw latch snaps tightly closed
- Models with built-in security eyelet accepts security seals and small padlocks to make the box tamper-evident (see security seal section for details)
- Made of industrial grade polymers

Item #	Description	Eyelet	Latch	Colour	Outside Dimensions (W x H x D)	UPC
1371	B Medical Box	-	1	● ● ●	12 x 4 x 5 <sup>5</sup> / <sub>8</sub> "	063636713713
1112	Box With Tray	-	2	● ● ●	13 x 6 x 5 <sup>1</sup> / <sub>2</sub> "	063636011123
1113	C Box With Tray	✓	2	● ● ●	13 x 6 x 5 <sup>1</sup> / <sub>2</sub> "	063636011130
1499-01	Box With Lift Out Tray	✓	1	●	14 x 5 <sup>1</sup> / <sub>4</sub> x 6 <sup>1</sup> / <sub>2</sub> "	063636144913
18631	Box With Lift Out Tray	✓	1	●	20 x 9 <sup>3</sup> / <sub>4</sub> x 9 <sup>1</sup> / <sub>4</sub> "	063636186319
18630	D Box With Lift Out Tray	✓	1	●	17 x 8 <sup>1</sup> / <sub>2</sub> x 8 <sup>1</sup> / <sub>2</sub> "	063636186302
18290	E Box With Lift Out Tray	✓	1	●	23 x 10 <sup>1</sup> / <sub>2</sub> x 11 <sup>3</sup> / <sub>8</sub> "	063636182908



Two secure lock latches for added security

## Plastic Utility Boxes

- Ideal for storing and organizing small supplies
- Additional dividers can be purchased (contact us for details)

Item #	Outside Dimensions (W x H x D)	Eyelet	# of Adjustable Dividers	Stationary Compartments	UPC
1600	3 x 1 <sup>1</sup> / <sub>4</sub> x 4 <sup>5</sup> / <sub>8</sub> "	-	-	1	063636716004
1601	<b>A</b> 3 <sup>3</sup> / <sub>4</sub> x 1 <sup>1</sup> / <sub>4</sub> x 7"	-	-	1	063636716011
1602	4 <sup>1</sup> / <sub>8</sub> x 1 <sup>7</sup> / <sub>16</sub> x 7"	-	6	3	063636716028
12555	<b>B</b> 9 x 2 x 7"	-	-	1	063636712556
1582-01	<b>C</b> 10 <sup>7</sup> / <sub>8</sub> x 1 <sup>3</sup> / <sub>4</sub> x 7 <sup>1</sup> / <sub>2</sub> "	✓	12	5	063636158293
1486	11 x 1 <sup>3</sup> / <sub>4</sub> x 6 <sup>3</sup> / <sub>4</sub> "	-	12	6	063636714864
1583-01	<b>D</b> 14 x 1 <sup>7</sup> / <sub>8</sub> x 8 <sup>1</sup> / <sub>2</sub> "	✓	20	4	063636158309
1477	<b>E</b> 14 x 2 x 9"	-	16	4	063636714772
1488	14 x 2 x 9"	-	16	4	063636714888
1599	14 x 3 <sup>3</sup> / <sub>4</sub> x 9 <sup>1</sup> / <sub>8</sub> "	-	11	4	063636715991
1585-01	14 x 3 <sup>3</sup> / <sub>4</sub> x 9 <sup>1</sup> / <sub>8</sub> "	-	-	1	063636158507

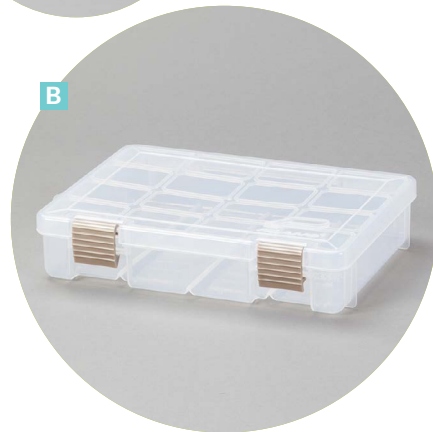
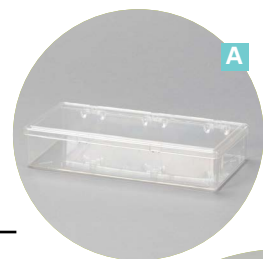

## Emergency Boxes

- Two cantilever trays
- Built-in security eyelet accepts security seals and small padlocks to make the box tamper-evident

Item #	Description	Outside Dimensions (H x W x D)	# of Compartments	UPC
1800	<b>F</b> Emergency Box	8 <sup>3</sup> / <sub>4</sub> x 17 <sup>5</sup> / <sub>8</sub> x 10 <sup>1</sup> / <sub>4</sub> "	3 top/5 bottom	063636718008
1802	Emergency Box	10 <sup>1</sup> / <sub>8</sub> x 19 x 10 <sup>3</sup> / <sub>4</sub> "	5 top/5 bottom	063636718022
2388-01	<b>G</b> Emergency Box Vinyl Label	6 <sup>1</sup> / <sub>8</sub> x 2 <sup>1</sup> / <sub>4</sub> "	-	063636023881

## Customize Your Utility Box!

- Apply custom labels to help identify the contents in your box!
- Custom imprint your company logo, department, inventory details or storage instructions!
- Add drilled holes for security seals & padlocks
- Contact customer service today!

## Self-Adhesive Pockets

- Adheres to almost any material
- Hold identification cards, instructions, dates, patient history, supply usage, etc
- Keep important material protected from dust, dirt, weather and visible for quick identification and access
- No need to have new labels printed each time information changes - simply update insert inside pocket

Item #	Size	Qty	UPC
1265	2 <sup>1</sup> / <sub>8</sub> x 3 <sup>1</sup> / <sub>2</sub> "	6	063636812652
1266	3 <sup>1</sup> / <sub>2</sub> x 5 <sup>1</sup> / <sub>4</sub> "	6	063636812669
1267	8 x 4"	5	063636812676



## Insulated Boxes

- Ideal for use as a disposable, mini lightweight cooler to transport and ship temperature-sensitive supplies!
- White cardboard box features a leak-resistant gusseted liner made from FDA-approved materials
- Liner's adhesive lip tape seals the contents for maximum protection
- Boxes are shipped flat with instructions for assembly on the bottom of each box

Item #	Outside Dimensions (W x H x D)	Qty	UPC
17878	8 x 8 x 8"	5	063636178789

## Tamper-Evident Boxes & Seals

- Maximize Storage - Tamper-evident boxes with lids allow easy viewing of contents for a convenient way to store, organize and access supplies.
- Stackable - Lid design allows boxes to stack. Sliding lid has a back-stop mechanism to prevent the lid from slipping off.
- Easy to Secure - Use with the consecutively numbered Tamper-Evident Box Seals (#18213, sold separately) to secure contents.

Item #	Description	Dimensions (W x H x D)	Qty	UPC
18212	<b>A</b> Tamper Evident Box, Large	5 <sup>7</sup> / <sub>8</sub> x 3 <sup>11</sup> / <sub>16</sub> x 2 <sup>7</sup> / <sub>8</sub> "	1	063636182120
18211	<b>B</b> Tamper Evident Box, Small	3 <sup>7</sup> / <sub>8</sub> x 1 <sup>3</sup> / <sub>4</sub> x 2 <sup>7</sup> / <sub>8</sub> "	1	063636182113
18213	<b>C</b> Tamper-Evident Box Seals	1 <sup>1</sup> / <sub>8</sub> x 7 <sup>7</sup> / <sub>8</sub> "	25	063636182137

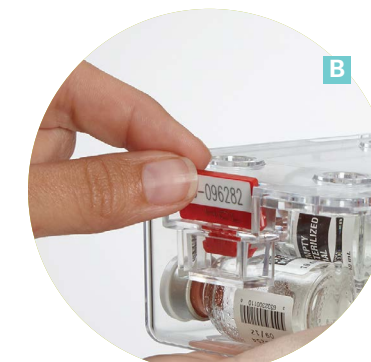
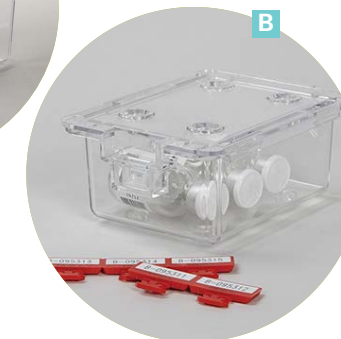
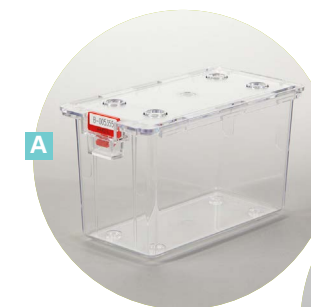



### Briefcase Drug Boxes

- Made of heavy-duty dent-proof plastic that resists common odors and solvents
- See-through lids assure quick identification of contents
- Available with or without security seal eyelets & adjustable dividers
- Security seal eyelets allow boxes to be sealed for documenting control while deterring tampering

Item #	Description	Security Seal Eyelet	Outside Dimensions (W x H x D)	UPC
1822	<b>A</b> Briefcase Drug Box, No Dividers	-	15 x 2 <sup>1</sup> / <sub>2</sub> x 11 <sup>3</sup> / <sub>4</sub> "	063636718220
1820	<b>B</b> Briefcase Drug Box with 15 Removable Dividers Customize 9 To 24 Compartments	-	15 x 2 <sup>1</sup> / <sub>2</sub> x 11 <sup>3</sup> / <sub>4</sub> "	063636718206
1821	Briefcase Drug Box with 15 Removable Dividers Customize 9 To 24 Compartments	✓	15 x 2 <sup>1</sup> / <sub>2</sub> x 11 <sup>3</sup> / <sub>4</sub> "	063636718213
1832	Briefcase Drug Box, No Dividers	✓	15 x 2 <sup>1</sup> / <sub>2</sub> x 11 <sup>3</sup> / <sub>4</sub> "	063636718329
1825	<b>C</b> Large Briefcase Drug Box with 24 Removable Dividers & 7 Permanent Customize With 8 To 32 Compartments	-	18 <sup>1</sup> / <sub>2</sub> x 3 x 13"	063636718251
1831	Large Briefcase Drug Box with 24 Removable Dividers & 7 Permanent Customize With 8 To 32 Compartments	✓	18 <sup>1</sup> / <sub>2</sub> x 3 x 13"	063636718312
1804	<b>D</b> Foam For Briefcase Drug Box, Blue (Fits #1822)	-	-	063636718046

### Security Drug Cases & Drug Storage Cases

- Secure Transport - Plastic cases with high-strength hinges and sliding positive lock latches with security seal eyelets. 1 or both latches can be locked with a security seal or small padlock.
- Seals sold separately. 2 cam locks on the 1453K case keep narcotics and other drug and emergency kits secure.
- Removable Foam - Liner (all except 1584K) protects vials, ampules, syringes and other supplies during transport.

Item #	Description	Dimensions (W x H x D)	UPC (063636)
1452K	<b>E</b> Security Drug Case with Removable Foam Liner	13 <sup>1</sup> / <sub>4</sub> x 3 x 10"	063636714529
1453K	Security Drug Case with 2 Key Locks	13 <sup>9</sup> / <sub>16</sub> x 3 x 10 <sup>1</sup> / <sub>8</sub> "	063636714536
1584K	<b>F</b> Drug Storage Case without Foam	10 <sup>1</sup> / <sub>2</sub> x 3 <sup>1</sup> / <sub>8</sub> x 8"	063636158415
1573K	Drug Storage Case without Foam	14 x 3 <sup>1</sup> / <sub>4</sub> x 11"	063636157319



### Pull Tight Seals

- Self-locking seal for easy application and removal – no tools required for removal
- Printable area – textured side ideal for writing
- Made out of polypropylene plastic, autoclavable up to 163°C
- Seal length: 9", tail length: 7", width: 1/16"
- **Average Breaking Strength: 11-14 lbs.**
- 100 per package

Item #	Description	Colour	UPC
7820	Pull Tight Security Seals, Consecutively Numbered	Red ●	063636778200
7813	Pull Tight Security Seals, Consecutively Numbered	Yellow ●	063636778132
7817	Pull Tight Security Seals, Consecutively Numbered	Green ●	063636778170
7816	Pull Tight Security Seals, Consecutively Numbered	Light Blue ●	063636778163
7814	Pull Tight Security Seals, Consecutively Numbered	White ○	063636778149
7930	Pull Tight Security Seals, Consecutively Numbered	Purple ●	063636793012
7821	Pull Tight Security Seals, Unnumbered	Red ●	063636778217
7823	Pull Tight Security Seals, Unnumbered	Yellow ●	063636778231
7825	Pull Tight Security Seals, Unnumbered	Green ●	063636778255
7827	Pull Tight Security Seals, Unnumbered	Blue ●	063636778279
7828	Pull Tight Security Seals, Unnumbered	White ○	063636778286
7931	Pull Tight Security Seals, Unnumbered	Purple ●	063636117931
7829	Pull Tight Security Seals, Unnumbered	Orange "Biohazard" ●	063636778293



Numbered



Unnumbered

### Pull Tight Baby Seals

- Self-locking seal for easy application and removal – no tools required for removal
- Smaller tail is ideal for securing tighter gaps and spaces
- Printable area – textured side of seal ideal for writing
- Made out of polypropylene plastic, autoclavable up to 163°C
- Seal length: 5", tail length: 4<sup>3</sup>/<sub>8</sub>", width: 1/16"
- **Average Breaking Strength: 10.5 lbs.**
- 100 per package



Numbered

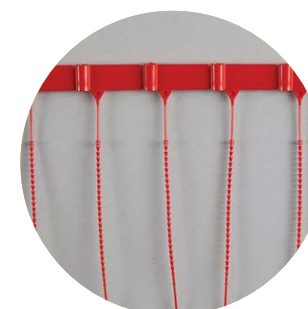

Unnumbered

Item #	Description	Colour	UPC
7923	Small Pull Tight Seals, Consecutively Numbered	Red ●	063636792312
7926	Small Pull Tight Seals, Consecutively Numbered	Yellow ●	063636792619
7917	Small Pull Tight Seals, Consecutively Numbered	Green ●	063636791711
7924	Small Pull Tight Seals, Consecutively Numbered	Blue ●	063636792411
7925	Small Pull Tight Seals, Consecutively Numbered	White ○	063636792510
7928	Small Pull Tight Seals, Consecutively Numbered	Orange ●	063636792817
7904	Small Pull Tight Seals, Unnumbered	Red ●	063636779047
7915	Small Pull Tight Seals, Unnumbered	Yellow ●	063636779153
7902	Small Pull Tight Seals, Unnumbered	Green ●	063636779023
7905	Small Pull Tight Seals, Unnumbered	Blue ●	063636779054
7929	Small Pull Tight Seals, Unnumbered	White ○	063636779290
7927	Small Pull Tight Seals, Unnumbered	Orange ●	063636779276

### Ring Pull Seals

- Unique self-locking ring-shaped seal for easy application and removal
- Allows quick access (no tools required for removal)
- Double-wall locking chamber secures seal, while providing tamper-evidence
- Ring shape ideal for securing boxes and carts
- Printable area – textured side ideal for writing
- Consecutively numbered seals for tracking and inventory control
- Polypropylene plastic, autoclavable up to 163°C
- Seal length: 9 1/4", seal tail length: 8", width: 1/16"
- **Average Breaking Strength: 23 lbs.**
- 100 per package

Item #	Colour	UPC
8120	Red ●	063636781200
8121	Yellow ●	063636781217
8122	Green ●	063636781224
8123	Blue ●	063636781231
8124	Orange ●	063636781248
8125	White ○	063636781255
8126	Grey ●	063636781262
8127	Black ●	063636781279

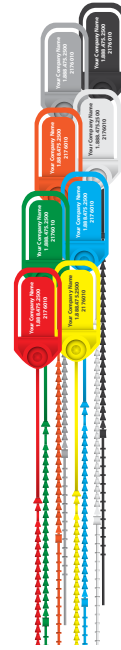

### Pull Tight Padlock Seals

- Combination of "pull tight" easy-adjust seal and the "padlock" style locking mechanism
- Blank seals – can be written on with permanent marker to identify contents, date, time, initials, etc.
- Polypropylene, autoclavable up to 117°C
- Seal length: 7 3/8", seal tail length: 6", width: 1/8"
- **Average Breaking Strength: 12.5 lbs.**
- 100 per package

Item #	Colour	UPC
7800	Black ●	063636778002
7801	Green ●	063636780111
7808	Red ●	063636778088
7809	Blue ●	063636778095
7810	White ○	063636778101
7811	Yellow ●	063636778118

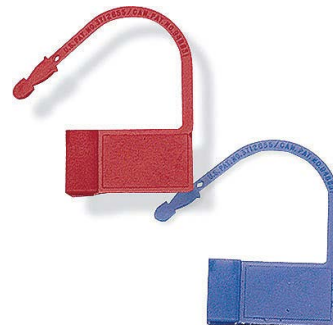

### Safety Control Seals

- Padlock-style locking arrow ideal for narrow slot openings (approximately 0.093" thick)
- One-piece plastic seal is easy to apply and break (simply pull to break)
- Blank 1" base – apply custom labelling
- 100 per package

Item #	Colour	UPC
4108-1	Red ●	063636741082
4108-2	Blue ●	063636841089

### Heavy Duty Pull Tight Seals

- Self-locking seal for easy application
- Heavy-duty seal provides security
- Requires scissors or knife for removal
- Consecutively numbered seals for tracking and inventory control
- Printable area – textured side of seal ideal for writing
- Made out of polypropylene plastic, autoclavable up to 163°C
- Seal Length: 9 1/2"
- Seal Tail Length: 7 1/8"
- Width: Approximately 1/16"
- **Average Breaking Strength: 35 lbs.**
- 100 per package

Item #	Colour	UPC
7843-10	Red ●	063636778330
7845-10	Blue ●	063636778224

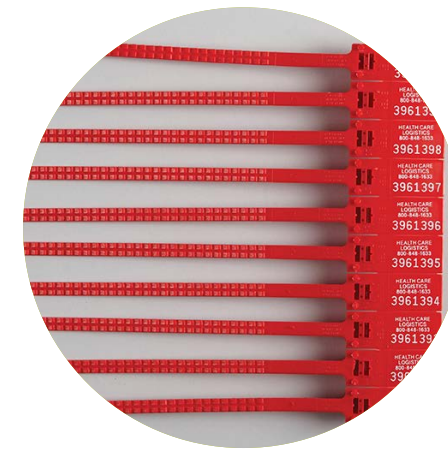

### Extra Heavy Duty Pull Tight Seals

- Self-locking seal for easy application
- Heavy-duty seal provides security
- Requires scissors or knife for removal
- Consecutively numbered seals for tracking and inventory control
- Printable area – textured side of seal ideal for writing
- Made out of polypropylene plastic, autoclavable up to 163°C
- Seal Length: 13 1/2"
- Seal Tail Length: 10 3/4"
- Width: Approximately 1/4"
- **Average Breaking Strength: 110 lbs.**
- 100 per package

Item #	Colour	UPC
7831	Red ●	063636778316
7830	Blue ●	063636778309
8186-10	Green ●	063636781866
8185-10	Yellow ●	063636781859
7853-10	Black ●	063636778538



### Padlock Seals

- Self-locking – no tools required for application or removal
- Spring-lock design will automatically open if not properly closed
- Simply twist to open
- Seals are numbered (not sequentially)
- Made out of polypropylene plastic, autoclavable up to 163°C
- Measures: 1.5" W x 1.875" H, width: 0.0625"
- **Average Breaking Strength: 8 lbs.**
- 100 per package

Item #	Colour	UPC
7901	Red ●	063636779016
7903	Yellow ●	063636779030
7906	Blue ●	063636779061
7910	White ○	063636779108
7912	Green ●	063636779122
7914	Purple ●	063636779146

### Extra Heavy Duty Blank Padlock Seals

- Extra-heavy duty strength provides security – cutting is recommended for removal
- Select from blank seals or consecutively numbered seals
- Polypropylene plastic, autoclavable up to 117°C
- Measures: 7/8" W x 1 3/8" H
- **Average Breaking Strength: 35 lbs.**
- 100 per package

Item #	Colour	UPC
7802	Red ●	063636778026
7803	Green ●	063636778033
7804	Yellow ●	063636778040
7818	<b>A</b> Orange ●	063636778187



### Easy Pull-Tight Seals, Numbered

- Average breaking strength: 11-14 lbs
- Tamper-Evident: One-piece, pull-tight, adjustable seal is designed to enhance safety by showing evidence of tampering
- Available in a variety of colours
- 100 per package
- Dimensions:  
Seal length - 8"  
Tail length - 7 9/16"

Item #	Description	UPC
18319	<b>B</b> Numbered	063636741082
18320	Unnumbered	063636183202

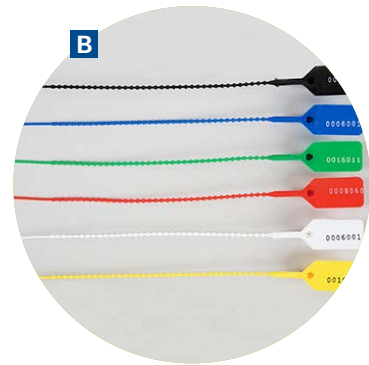

### Twin Tote Seals, 7"

- Security - Totes require two seals to be properly secured, the Twin Tote Seal is always manufactured in sequential "twin" sets with identical numbers.
- Average breaking strength - 45 lb.
- Quantity: 200/pack

Item #	Description	UPC
17472	<b>C</b> Numbered	063636174729

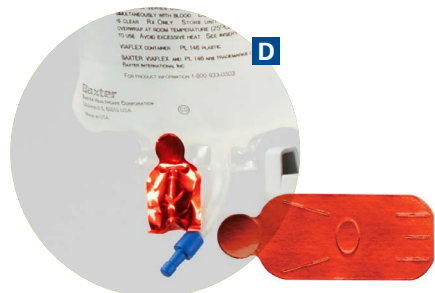

### Bag Port Seals

- Sterile seals protect the point of entry of IV admixtures from contamination and accidental double dosing
- Seals self-destruct upon attempted removal to show evidence of tampering
- Smart choice for USP compliance
- Specify colour when ordering, see details below
- Packaged in a dispensing box, 1000 per package

Item #	Description	UPC
7893	<b>D</b> For Baxter's Viaflex & Mini-Bag Plus Containers Colours: ● blue, ● green, ● red, ● yellow	063636778934
5315	<b>E</b> For Abbott's Large Bags & ADD-Vantage System	063636753153
5316	<b>F</b> For McGaw's Excel Bags & Abbott's Small Bags Colours: ● red, ● blue, ● green Tamper Resistant Add-Port Caps	063636753160



### Steri-Tamp® Sterile Tamper Evident Seals

- The only tamper evident seal that provides a 100% sterile barrier
- Protects against contamination and accidental double dosing
- Alerts staff when a drug has been added
- Patented dual-layer leaves true tamper evidence with "Opened" labelling left behind
- The foil top layer provides evidence of needle puncture
- Allows pharmacy to recycle medication and protects patients from dosing errors
- Maintains adhesion, even when refrigerated or frozen in cold drug storage conditions
- Packaged in easy-to-use dispensers



### Steri-Tamp® Tamper Evident Vial Seals

- Barrier Protection - Protects Against Contamination and Accidental Double Dosing. Identify if a previously opened vial or IV bottle has been tampered with
- Single Use - Gamma sterilized and intended for single use. The target area remains sterile until removed from the liner
- Tamper Evident - Foil outer layer provides visible evidence of a needle puncture. Leaves a printed "OPENED" warning and cannot be reapplied.
- Refrigerator Safe - Seals maintain adhesion when refrigerated or frozen in cold drug storage conditions
- Convenient Packaging - Packaged in a plastic clamshell container with hanging tab for dispensing
- **Note:** For use with vials only

Item #	Size	Colour	Qty	UPC
18297	<b>A</b> 13 mm	Red	1000	063636182977
18298	<b>B</b> 20 mm	Chrome	1000	063636182984
18299	<b>C</b> 28 mm	Blue	1000	063636182991



### Steri-Tamp® IV Bag Belly Button Port Seal

- Sterile Barrier - Maintains a 100% sterile barrier if properly applied. Notches allow seal to lay flat to prevent bacteria from channeling to the port.
- Features a lint-free plastic liner that will not shed particulate – USP 797 compliant

Item #	Size	Colour	Qty	UPC
18502	<b>D</b> 13 mm	Green	1000	063636185022

### Steri-Tamp® IV Bag Port Seals

- Sterile Barrier - Maintains a sterile barrier if properly applied.
- Refrigerator Safe - Seals maintain adhesion when refrigerated or frozen in cold drug storage conditions.
- USP <797> Friendly - Seals feature a lint-free plastic liner and are packaged in a plastic clamshell dispensing container that will not shed particulate.
- Protects the point of entry of IV admixtures from contamination and accidental double dosing
- Yellow seal marked "CHEMO"

Item #	Size	Colour	Qty	UPC
18296R	1 1/4 x 2"	Red	1000	063636182960
18296B	<b>A</b> 1 1/4 x 2"	Blue	1000	063636182960
18695	<b>B</b> 1 1/4 x 2"	Yellow	1000	063636186951

### Tamper Evident Vial Seals

- Offers a reliable moisture, particulate and bacterial barrier when properly applied
- Punctures are highly visible in laminated foil
- Adhesive allows application prior to freezing or refrigeration
- Surface material remains sterile until removed from the paper backing
- Latex free
- Specify colour: ● blue, ● green, ● yellow, or ● red
- Packaged in an easy dispensing box

Item #	For Vial Top Size	For Vials with a capacity of:	Qty	UPC
7866	13 mm	2 mL, 5 mL, 10 mL, 20 mL	1100	063636778668
7867	<b>C</b> 20 mm	30 mL	1000	063636778675
7887	28 mm	30 mL	1000	063636778873
7885	36 mm	30 mL	1000	063636778859

### Tamper Evident Seals with Pre-Printed Messages

- Tamper-Evident - Seals are preprinted with a chemotherapy message to quickly identify contents in bags, syringes, vials and bottles
- Sterile Barrier - When applied properly surface remains sterile until removed from the backing
- Single Use - Needle punctures are highly visible and the seals cannot be reapplied once removed
- Accommodates 28 mm bottle tops
- Packaged in a dispensing box, 1000 per package

Item #	Description	Qty	UPC
7990	<b>D</b> Chemotherapy Bag Port Seal	1000	063636879907



### Tamper Evident Oral Tip Caps

- Three-part plastic cap for Baxa ExactaMed Oral dispensers
- Secure, non-sterile cap requires user to break off outer sleeve in order to dispense medication
- Tamper-indicating red ring remains in place, indicating outer sleeve has been removed
- Cap is made of polypropylene, sleeve of polystyrene plastic
- Latex free

Item #	Qty	UPC
52300	100	063636723002



### Tamper-Evident Luer Lock Tip Caps

- Three-part plastic cap used to indicate tampering on a luer lock syringe
- Sterile and non-pyrogenic in unopened, undamaged package
- Latex free

Item #	Qty	UPC
64010	100 (Trays of 10)	063636840105

### Tamper Indicating Seals

- Silver foil tamper indicating seals
- Ideal for syringes (plungers or caps), prescription bottles, small ointment tubes, screw top vials, etc.
- Latex free
- Measures: 1 3/4" x 3/4"
- Packaged in a dispensing box

Item #	Qty	UPC
30020	1000	063636700201



### Tamper Evident Tape Strips

- Compatible - Pre-printed tape strips adhere to boxes, specimen vials, and other hard to secure items in order to show tampering once ripped
- Tape reads - Integrity Seal, Sealed by and Date.
- Each strip measures 6<sup>5</sup>/<sub>8</sub>" x 1<sup>3</sup>/<sub>8</sub>"

Item #	Qty	UPC
12281	100	063636712280



### Tamper Indicating Seals

- Security Message - Laminated label reveals a prominent VOID/OPEN security message when lifted. Choose Residue (7957) or No Residue (7958).
- Numbered - For traceability
- Quantity - 250 per roll

Item #	Description	Colour	Dimensions (W x H)	UPC
7958R	No residue	Red	2 <sup>3</sup> / <sub>16</sub> x 3 <sup>3</sup> / <sub>4</sub> "	063636079581
7958B	No residue	Blue	2 <sup>3</sup> / <sub>16</sub> x 3 <sup>3</sup> / <sub>4</sub> "	063636079581
7957R	Residue	Red	3 <sup>3</sup> / <sub>8</sub> x 1"	063636079574
7957B	Residue	Blue	3 <sup>3</sup> / <sub>8</sub> x 1"	063636079574

### Tamper Resistant Tape

- Ideal for hard to secure items such as jar tops, bottle caps, syringes, vials, etc.
- Tape molds easily to any item
- Pre-printed in black
- Packaged in an easy-dispensing box

Item #	Width	Length	Qty	Colour	UPC
8005	<b>A</b> 2"	164 Feet	1 roll	Red	063636345631
8000	<b>B</b> 1/2"	108 Feet	2 rolls	Red	063636780005
8002	<b>C</b> 1/2"	108 Feet	2 rolls	Clear	063636800208
8006	<b>D</b> 1"	108 Feet	1 roll	Red	063636800604
8008	<b>E</b> 1/2"	108 Feet	2 rolls	Red	063636080082
19703	<b>F</b> 1/2"	50 Feet	1 roll	Yellow	063636197032
19027	<b>G</b> 1/2"	50 Feet	1 roll	Blue	063636190279



### Steri-Tamp® Syringe Seal

- Non-sterile solution to provide tamper evidence and helps prevent risk of double dosing
- Metalized polyester seal rips apart to show tampering
- Maintains adhesion when refrigerated or frozen in cold drug storage conditions
- Smart choice for USP compliance
- Packaged in a dispensing box

Item #	Colour	Length	Qty	UPC
18853	Red	4 <sup>1</sup> / <sub>4</sub> "	1000	063636188535

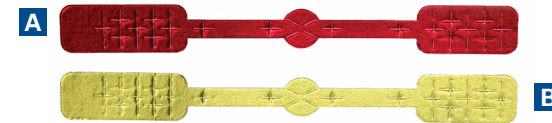

### Syringe Seals

- Multi-Use - Non-sterile seals can be used on all syringes, vials, boxes, otic/ophthalmic containers, etc.
- Molds Easily - Flexible foil seals attach to syringe caps or sheaths. Cannot be reapplied once removed. Non-sterile solution to provide tamper evidence and help prevent risk of double dosing
- Foil material wrinkles or tears upon removal to show tampering
- Smart choice for USP compliance
- Packaged in a dispensing box

Item #	Colour	Length	Qty	UPC
7868Y	<b>A</b> Yellow	4 <sup>1</sup> / <sub>4</sub> "	1000	063636078683
7868R	<b>B</b> Red	4 <sup>1</sup> / <sub>4</sub> "	1000	063636786816



### Tamper Evident Syringe Seals with Pre-Printed Messages

- Pre-printed with "Do Not Use if Seal Is Broken" in red
- Cannot be re-attached once removed
- Packaged in a dispensing box

Item #	Colour	Size	Length	Qty	UPC
7997	<b>C</b> Silver	Short	3 <sup>5</sup> / <sub>8</sub> "	1000	063636879976
7998	<b>D</b> Silver	Long	4 <sup>1</sup> / <sub>4</sub> "	1000	063636879983
8001	<b>E</b> White	Short	3 <sup>1</sup> / <sub>2</sub> "	1000	063636880019



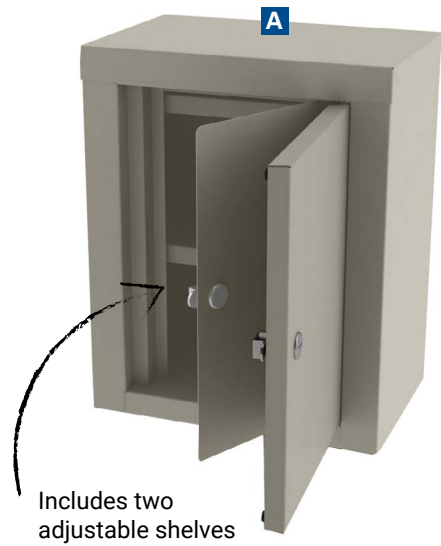

Includes two adjustable shelves



Includes three adjustable shelves



Double walled door



Cabinets are keyed differently with two keys per lock



Includes one fixed shelf & two adjustable shelves



Double-walled outer door and panel inner door, both with separate key locks



Double walled outer door and a panel inner door



Steel cabinet has an enamel finish and acrylic windows



Cabinet with handle is ideal for small spaces



**Narcotic Cabinets**

Item #	Description	Steel	# of Doors	Locks per Door	Total # of Locks	# of Shelves	Dimensions			UPC
							Width	Height	Depth	
3700	<b>A</b> Small Double Door	20 gauge	2	1	2	2 adjustable	12 <sup>1</sup> / <sub>8</sub> "	15"	8 <sup>1</sup> / <sub>8</sub> "	063636737009
3705	<b>B</b> Large Double Door	20 gauge	2	1	2	3 adjustable	18 <sup>1</sup> / <sub>8</sub> "	24"	12 <sup>1</sup> / <sub>8</sub> "	063636737054
3780	<b>C</b> Small Single Door	20 gauge	1	2	2	1 adjustable	14"	12"	8"	063636737801
3772	<b>D</b> Single Door, Single Lock	18 gauge	1	1	1	3 (1 fixed, 2 adjustable)	24"	30"	10"	063636737726
3782	<b>E</b> Single Door, Double Lock	18 gauge	1	2	2	3 (1 fixed, 2 adjustable)	24"	30"	10"	063636737825
3704	<b>F</b> Double Door, Double Lock	20 gauge	2	1	2	1 fixed	12"	15"	8"	063636937041
3886	<b>G</b> Double Door, Double Lock	20 gauge	2	1	2	3 adjustable	18"	30"	8"	063636038861
3708	<b>H</b> Large Locking Cabinet	20 gauge	1	1	1	1 fixed, 1 adjustable	30"	30"	12"	063636937089
3761-01	<b>I</b> Compact Security Cabinet	20 gauge	1	2	2	-	7.25"	8.75"	6"	06363676109
3706-01	<b>J</b> Slim Security Cabinet	20 gauge	1	2	2	2 fixed	8"	12 <sup>1</sup> / <sub>8</sub> "	2 <sup>3</sup> / <sub>8</sub> "	063636737061

**Narcotic Cabinet Features:**

- Piano hinge prevents pin removal
- Predrilled holes for mounting
- Contact our customer service team to find out about additional keying options and making duplicates from your original key!



Four digit code required to access contents



Keyless Entry Digital Lock (first door only; key lock on second door)



Keyless entry digital lock allows staff to secure drugs without needing extra keys. Lock can be programmed with multiple user codes to prevent unauthorized access.

**Keyless Entry Digital Lock Narcotic Cabinets**

Item #	Description	Steel	# of Doors	Keyless entry digital lock	# of Shelves	Dimensions			UPC
						Width	Height	Depth	
17846	<b>A</b> Security Cabinet, KEDL	18 gauge	1	✓	3 (1 fixed, 2 adjustable)	24 <sup>1</sup> / <sub>8</sub> "	30"	10 <sup>1</sup> / <sub>16</sub> "	063636178765
19948	<b>B</b> Security Cabinet, KEDL with Audit Trail	20 gauge	2	✓ and lock	3 adjustable	18"	30"	8"	063636199487
20397	<b>C</b> Slim Security Cabinet, KEDL	20 gauge	1	✓	2 fixed	8"	12 <sup>1</sup> / <sub>8</sub> "	2 <sup>3</sup> / <sub>8</sub> "	063636203979

**Locking Key Storage Boxes**

- Secure Storage - Mount to any flat surface to keep keys locked but accessible using a push-button combination.
- Heavy Duty - Made of rustproof zinc alloy metal.

Item #	Capacity	Dimensions (W x H x D)	UPC
10430	<b>A</b> 2-key	2 <sup>1</sup> / <sub>4</sub> x 3 <sup>7</sup> / <sub>8</sub> x 1 <sup>5</sup> / <sub>8</sub> "	063636104306
10431	<b>B</b> 5-key	2 <sup>1</sup> / <sub>2</sub> x 4 <sup>1</sup> / <sub>8</sub> x 1 <sup>7</sup> / <sub>8</sub> "	063636104313
10432	<b>C</b> Keys & Credit-Card Style Storage	3 <sup>1</sup> / <sub>2</sub> x 4 <sup>3</sup> / <sub>4</sub> x 2 <sup>3</sup> / <sub>4</sub> "	063636104320



**Lockable Storage Cabinet**

- Secure Storage - Lockable steel cabinet keeps sensitive drugs secure. Includes four adjustable shelves and a key lock with two keys
- Organize Supplies - Sort items inside bins or supply drawers (not included) for quick, easy retrieval
- Wall-Mount - Powder-coated storage locker mounts to the wall for convenient access in a consistent location

Item #	Dimensions (W x H x D)	UPC
20150	<b>D</b> 19 <sup>1</sup> / <sub>4</sub> x 38 x 15 <sup>1</sup> / <sub>8</sub> "	063636020156

**Briefcase Drug Boxes**

- Boxes are an excellent way to customize drug and supply kits for exchanges, emergency room and ambulance use.
- Comes with 15 removable dividers. Customize with 9 to 24 compartments.
- Dimensions: 15"W x 2<sup>1</sup>/<sub>2</sub>"H x 11<sup>3</sup>/<sub>4</sub>"D

Item #	Description	UPC
1820	<b>E</b> Briefcase drug box w/ 15 removable dividers	063636718206
1821	Briefcase drug box w/ security seal holes	063636718213
1822	Briefcase drug box, no dividers or security seal holes	063636718220
1832	Briefcase drug box w/ security seal holes, no dividers	063636718329

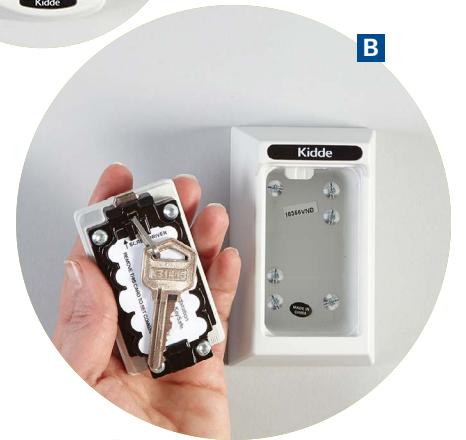

View all Briefcase Drug Boxes on page 50.

### Custom Sizes & Printing Available!

Customize the following:

- Size: Most of the blank bags offered can be custom imprinted
- Quantity: 500 bag minimum
- Imprint Area: Select from 1 3/4 x 3 1/2", 3 1/2 x 3 1/2" & 4 x 4"
- Imprint Colour: Select from black, blue, green, orange, pink, purple, red, yellow or white text
- Message: Add text or symbols

Contact us for details or to place your order!

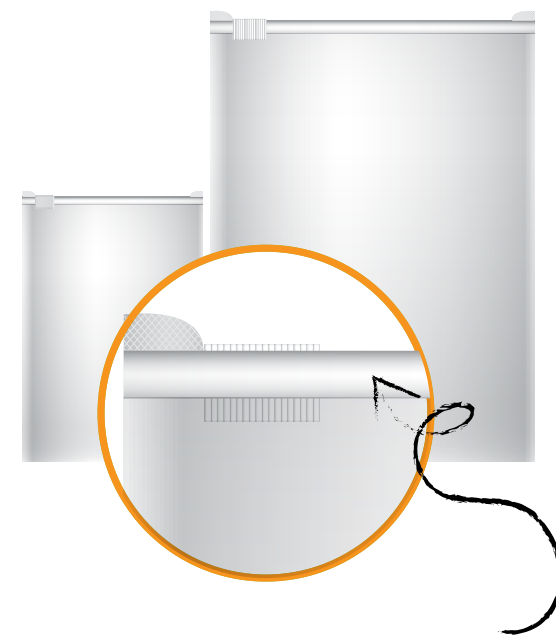

Double track zippers provide added strength and durability

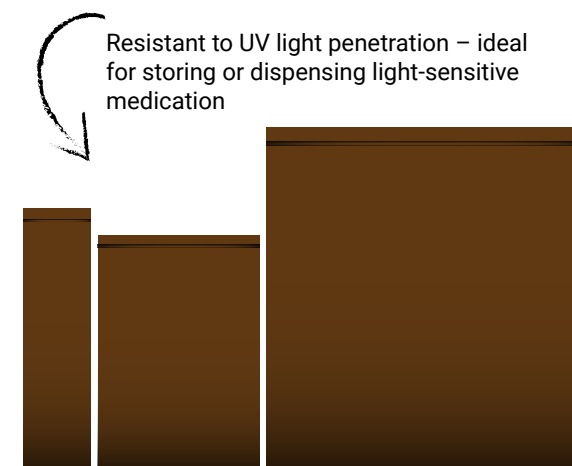

Resistant to UV light penetration – ideal for storing or dispensing light-sensitive medication

### Clear Zip It Bags, Regular Strength

- Resealable poly bags with a single track zipper closure
- Latex free
- 2 mil thick

Item #	Size	Qty	UPC (063636)
MG2X2	2 x 2"	1000	063636237226
MG2X3	2 x 3"	1000	063636137236
MG2X8	2 x 8"	1000	063636137281
MG3X3	3 x 3"	1000	063636137335
MG3X4	3 x 4"	1000	063636137342
MG3X5	3 x 5"	1000	063636137359
7521	3 x 12"	100	063636775216
MG3X12	3 x 12"	1000	063636133122
MG4X4	4 x 4"	1000	063636137441
MG4X6	4 x 6"	1000	063636137465
MG4X8	4 x 8"	1000	063636137489
MG5X7	5 x 7"	1000	063636137571
MG6X4	6 x 4"	1000	137649063636
MG6X6	6 x 6"	1000	661007063636
MG6X8	6 x 8"	1000	137687063636
MG6X9	6 x 9"	1000	137694063636
MG6X10	6 x 10"	1000	137618063636
MG8X8	8 x 8"	1000	137885063636
MG8X10	8 x 10"	1000	137816063636
MG10X10	10 x 10"	1000	121013063636
MG9X12	9 x 12"	1000	137922063636
MG10X12	10 x 12"	1000	137021063636
MG10X13	10 x 13"	1000	137038063636
MG12X12	12 x 12"	1000	137212063636
MG12X15	12 x 15"	1000	137250063636
MG13X15	13 x 15"	1000	137137063636
MG13X18	13 x 18"	1000	137380063636



Can be used to package, dispense or store almost any item

### Resealable Bags

- Latex free

Item #	Description	Zipper	UV Resistant	Size	Thickness	Qty	UPC
M4G3X4	Clear Zip It Bags, Resealable	Single	-	3 x 4"	4 mil	1000	063636138349
M4G3X5	Clear Zip It Bags, Resealable	Single	-	3 x 5"	4 mil	1000	063636138356
M4G4X4	Clear Zip It Bags, Resealable	Single	-	4 x 4"	4 mil	1000	063636138448
M4G4X6	Clear Zip It Bags, Resealable	Single	-	4 x 6"	4 mil	1000	063636138462
M4G5X8	Clear Zip It Bags, Resealable	Single	-	5 x 8"	4 mil	1000	063636138585
M4G6X6	Clear Zip It Bags, Resealable	Single	-	6 x 6"	4 mil	1000	063636138660
M4G6X9	Clear Zip It Bags, Resealable	Single	-	6 x 9"	4 mil	1000	063636138691
M4G8X10	Clear Zip It Bags, Resealable	Single	-	8 x 10"	4 mil	1000	063636138806
M4G9X12	Clear Zip It Bags, Resealable	Single	-	9 x 12"	4 mil	1000	063636138929
M4G10X10	Clear Zip It Bags, Resealable	Single	-	10 x 10"	4 mil	1000	063636138004
M4G10X13	Clear Zip It Bags, Resealable	Single	-	10 x 13"	4 mil	1000	063636138134
M4G12X12	Clear Zip It Bags, Resealable	Single	-	12 x 12"	4 mil	1000	063636138226
M4G12X15	Clear Zip It Bags, Resealable	Single	-	12 x 15"	4 mil	1000	063636138257
M4G13X18	Clear Zip It Bags, Resealable	Single	-	13 x 18"	4 mil	1000	063636138387
7567M	Amber Zip It Bags, Resealable	Single	✓	2.5 x 9"	3 mil	1000	063636775674
7570M	Amber Zip It Bags, Resealable	Single	✓	3 x 5"	3 mil	1000	063636775704
7573M	Amber Zip It Bags, Resealable	Single	✓	4 x 6"	3 mil	1000	063636775735
7575M	Amber Zip It Bags, Resealable	Single	✓	6 x 8"	3 mil	1000	063636775759
7576M	Amber Zip It Bags, Resealable	Single	✓	8 x 8"	3 mil	1000	063636775766
7588M	Amber Zip It Bags, Resealable	Single	✓	8 x 14"	3 mil	1000	063636775889
7578M	Amber Zip It Bags, Resealable	Single	✓	12 x 12"	3 mil	1000	063636775780
10811	Clear Slider Bags, Resealable	Double	-	7 x 9"	2 mil	100	063636980115
10812	Clear Slider Bags, Resealable	Double	-	8 X 10"	2 mil	100	063636139810
10813	Clear Slider Bags, Resealable	Double	-	9 X 12"	2 mil	100	063636139919
10814	Clear Slider Bags, Resealable	Double	-	10 x 12"	2 mil	100	063636180140
10815	Clear Slider Bags, Resealable	Double	-	12 x 15"	2 mil	100	063636108151

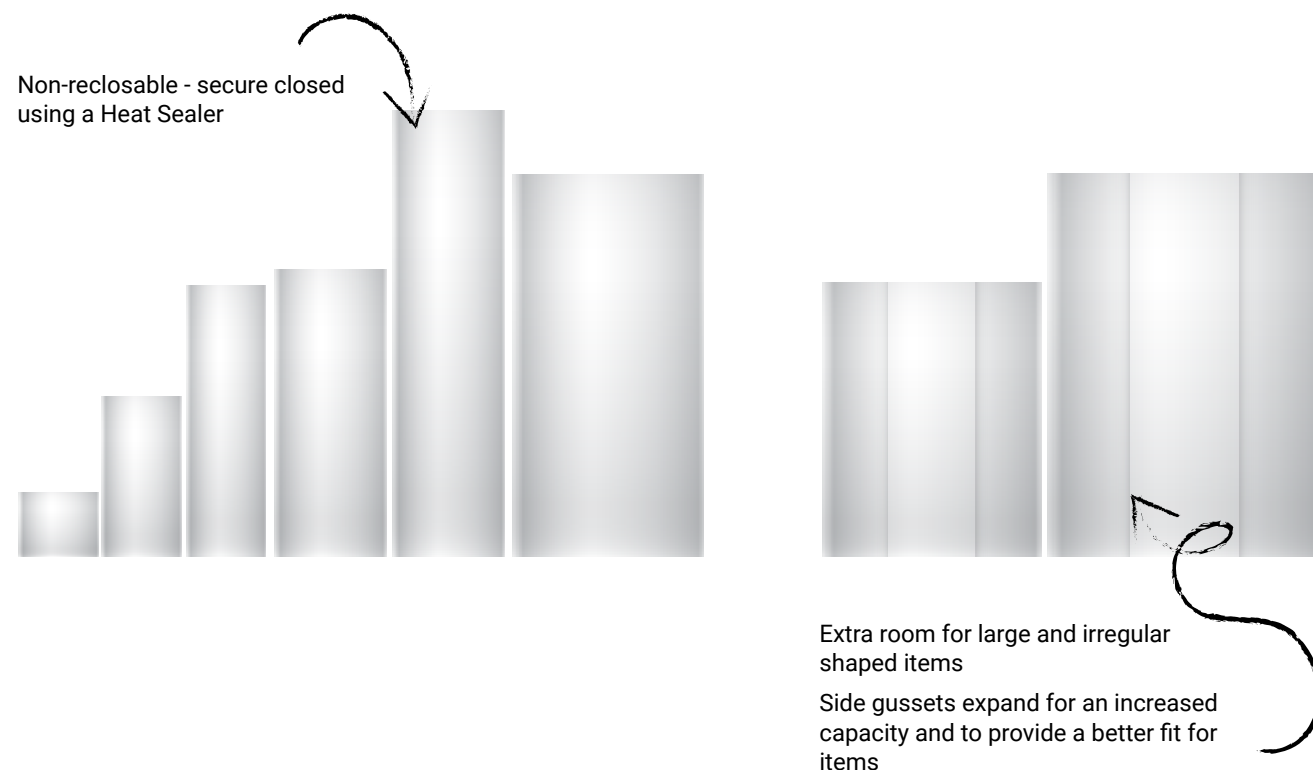

### Non-Reclosable Bags

Item #	Description	Size	Qty	UPC
MP-410-22	Poly Bags for Tablets, Non-Reclosable	2 1/2 x 2"	1000	063636710224
MP-410-25	Poly Bags for Large Ampules, Non-Reclosable	2 1/2 x 5"	1000	063636810252
MP-410-28	Poly Bags for Syringes, Non-Reclosable	2 1/2 x 8.5"	1000	063636710286
BPB3X9	Block Poly Bags for Syringes, Non-Reclosable	3 1/2 x 9"	1000	063636139391
BPB314	Blocked Poly Bags, Non-Reclosable	3 1/2 x 14"	1000	063636773144
PB6X12	Poly Bags, Non-Reclosable	6 x 12"	1000	063636139629
7652	Poly Bags, Non-Reclosable	3 x 5"	100	063636775162
7654	Poly Bags, Non-Reclosable	4 x 6"	100	063636775308
7656	Poly Bags, Non-Reclosable	6 x 9"	100	063636775315
GB141022	Gusseted Bags, Non-Reclosable	14 x 10 x 22"	1000	063636810221
GB10824	Gusseted Bags, Non-Reclosable	10 x 8 x 24"	1000	063636708245
GB4212	Gusseted Bags, Non-Reclosable	4 x 2 x 12"	2000	063636842123
GB6315	Gusseted Bags, Non-Reclosable	6 x 3 x 15"	1000	063636763152
GB1218	Gusseted Bags, Non-Reclosable	12 x 18"	1000	063636712181

### Heat Sealers

- Heat sealer for plastic to ensure water-tight and air-tight seal
- Effective for autoclaving and heat sealing procedures
- Ideal for use with poly bags - can be customized to the desired length
- Ideal for packaging
- Can be used with most plastic materials (up to 0.2mm or 6 mil thick); including: polyethylene, polyurethane, polyvinylchloride, polypropylene, pliofilm, kel-f, polyflex, mylar, P.V.A., tivac, saran, and nylon
- Requires 110V outlet

- 3 prong grounded plugs
- Front of each sealer has a control knob that allows easy temperature adjustment and an indicator light to show when the sealer is ready to use
- Package includes: 1 heat sealer, 1 heating wire, 1 upper cloth
- Replacement parts available separately (select from full kit, or purchase parts individually, see below)

Item #	Size	UPC
HS200	8" Heat Sealer	063636772000
HS300	12" Heat Sealer	063636773007

Heat Sealer	Description	For use	UPC
MP-200	HS200 Replacement Kit Includes: Glass Tape, Pressure Pad Cover & Flat Wire	HS200	063636300111
MP-300	HS300 Replacement Kit Includes: Glass Tape, Pressure Pad Cover & Flat Wire	HS300	063636300128
MP-21011-12	Glass Tape (.5"W)	HS300	063636711122
MP-21042-8	Pressure Pad Cover	HS200	063636704285
MP-21042-12	Pressure Pad Cover	HS300	063636742126
MP-21039-8	Element Wire (Flat)	HS200	063636703981
MP-21039-12	Element Wire (Flat)	HS300	063636739126
MP-21039A-8	Element wire (Round)	HS200	063636739287
MP-21039A-12	Element wire (Round)	HS300	063636792121
MP-2106-8	Teflon Cover (1 1/2"W)	HS200	063636710682
MP-2106-12	Teflon Cover (1 1/2"W)	HS300	063636706128



### Tablet Crusher & Pouches

- Clear plastic pouches safely contains pills during crushing process, eliminating cross contamination and unnecessary clean up
- Latex-free
- 7 mil thick polyethylene

Item #	Description	Qty	UPC
7414-31	Pouches, 2" x 4 3/4"	1000	063636714314
7414-10	Pouches, 2" x 4 3/4"	100	063636714109
7424-01	Silent Knight® 10 1/2 x 3 x 4 1/2"	1	063636074241



#### Silent Knight®

- Quiet and powerful pill crusher - silently crushes tablets without disturbing patients
- Ideal for use during night or early morning shifts
- Features OxiTitan™ antimicrobial coating to help fight infections
- Can be cleaned with any disinfecting cleaner
- Crushes pills and tablets into fine powder- reduces risk of clogging feeding tubes
- Requires minimum force to crush tablets, reducing risk of wrist or arm injuries
- Storage compartment provides easy access to pouches

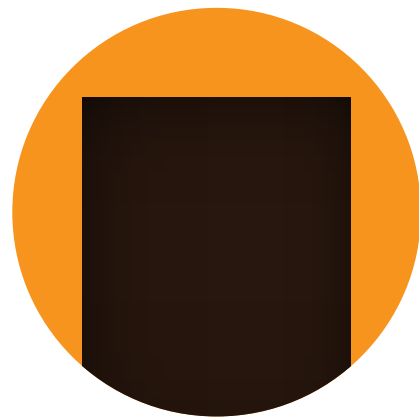

## UV Bags

- Ideal for light-sensitive medication and IV's
- Amber bags absorb 92% to 98% of light in the UV range
- Labels can be read through amber bags, eliminating the need for double labelling
- Latex free
- 2 mil thick

Item #	Description	Size (L x H)	Qty	UPC
ST-320-57	Slit-Top UV Bags For Piggyback IVs (250 mL)	5 x 8.5"	500	063636820572
ST-320-60	Slit-Top UV Bags For 1/2-Liter IV Bags (500 mL)	6 x 10"	1000	063636820602
ST-320-64	Slit-Top UV Bags For 1-Liter IV Bags (1000 mL)	6 x 14"	1000	063636820640
ST-320-84D	Slit-Top UV Bags For 1-Liter IV Bottles (1000 mL)	8 x 14"	500	063636320843
ST-320-84M	Slit-Top UV Bags For 1-Liter IV Bottles (1000 mL)	8 x 14"	1000	063636420840
ST-320-108	Slit-Top UV Bags For 3-Liter IV Bags (3000 mL)	10 x 18"	250	063636801083
ST-320-128	Slit-Top UV Bags For 4-Liter IV Bags (4000 mL)	12 x 18"	250	063636801281
MP-320-22	Regular UV Bags For Tablets	2.5 x 2"	1000	063636720223
MP-320-25	Regular UV Bags For Large Ampules	2.5 x 5"	1000	063636820251
MP-320-28	Regular UV Bags For Syringes	2.5 x 8.5"	1000	063636720285
MP-320-314	Regular UV Bags For Large Syringes	3 x 14"	1000	063636703141
MP-320-57	Regular UV Bags For Piggyback IVs (250 mL)	5 x 8.5"	500	063636720575
MP-320-60	Regular UV Bags For 1/2-Liter IV Bags (500 mL)	6 x 10"	1000	063636720605
MP-320-64	Regular UV Bags For 1-Liter IV Bags (1000 mL)	6 x 14"	1000	063636720643
MP-320-84D	Regular UV Bags For 1-Liter IV Bottles (1000 mL)	8 x 14"	500	063636720841
MP-320-84M	Regular UV Bags For 1-Liter IV Bottles (1000 mL)	8 x 14"	1000	063636820848
MP-320-108	Regular UV Bags For 3-Liter IV Bags (3000 mL)	10 x 18"	250	063636701086
MP-320-128	Regular UV Bags For 4-Liter IV Bags (4000 mL)	12 x 18"	250	063636701284
AUZ35	UV-Zip Reclosable Zipper Bags	3 x 5"	1000	063636800352
AUZ39	UV-Zip Reclosable Zipper Bags	3 x 9"	1000	063636800390
AUZ46	UV-Zip Reclosable Zipper Bags	4 x 6"	1000	063636800468
AUZ58	UV-Zip Reclosable Zipper Bags	5 x 8"	1000	063636800581
AUZ69	UV-Zip Reclosable Zipper Bags	6 x 9"	1000	063636800697
AUZ814	UV-Zip Reclosable Zipper Bags	8 x 14"	1000	063636808143
AUZ912	UV-Zip Reclosable Zipper Bags	9 x 12"	1000	063636809126

IV tubing Covers extends the effectiveness of UVLI bags by protecting or binding the drug all the way to the patient!



## Opacity Chart

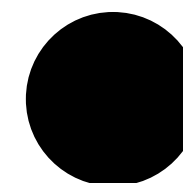

Dark

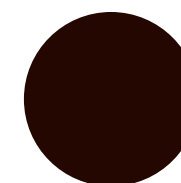

Medium

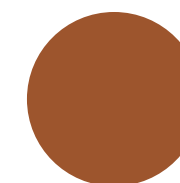

Light

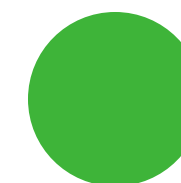

Green

## IV Covers & Bags

- Ideal for dispensing and covering IV admixtures that contain light sensitive medication
- Amber protects IV tubing from exposure to light

Item #	Description	Tint	Size	Qty	UPC
7589	<b>A</b> IV Cover, slit at sealed end	Light	8 x 14"	100	063636875893
7587	IV Cover, slit at sealed end	Amber	6 x 10"	100	063636775872
7587D	<b>B</b> IV Cover	Dark	6 x 10"	100	063636875879
7589D	IV Cover, slit at sealed end	Dark	8 x 14"	100	063636775896
7590D	IV Cover	Dark	8 x 14"	100	063636775902
19643	IV Cover	Amber	12 x 18"	100	063636196431
7583	<b>C</b> IV Cover, slit at sealed end	Green	8 x 14"	100	063636775834
7584	IV Cover, slit at sealed end	Green	6 x 10"	100	063636775841
7590L	IV Cover	Amber	8 x 14"	100	063636075903
7579	IV Cover, slit at sealed end	Green	5 x 8.5"	100	063636775797
7617	IV Tubing Cover	Amber	2 1/2 x 72"	10 strips	063636776176
590-UT300	IV Tubing Cover	Amber	2 1/2 x 300'	1 Roll	063636590307
590-UT1000	IV Tubing Cover	Amber	2 1/2 x 1000'	1 Roll	063636590109
590-UT	IV Tubing Cover	Amber	2 1/2 x 2500'	1 Roll	063636590116

### Easy Write Zip It Bags

- Write-on Area - Designed with a white write-on block for writing text
- Small Package Quantities - Allows bags to be ordered without buying a year's supply
- Versatile - Can be used to package, dispense or store almost any item
- Closure - Reclosable zipper

Item #	Size	Thickness	Qty	UPC
7538M	2 x 3"	2 mil	1000	063636775384
7540M	3 x 4"	2 mil	1000	063636775407
7543M	3 x 5"	2 mil	1000	063636775438
7546M	4 X 6"	2 mil	1000	063636775469
7547M	<b>A</b> 5 x 8"	2 mil	1000	063636775476
7548M	6 x 9"	2 mil	1000	063636775483
7555M	8 x 10"	2 mil	1000	063636775551
7557M	9 X 12"	2 mil	1000	063636775575

### Patient Bags

- Reclosable with a single track zipper
- Pre-printed form with blue ink
- For neat, professional labelling
- 2 mil thick

Item #	Size	Thickness	Qty	UPC
7550	<b>B</b> 3 x 4"	2 mil	100	063636775506
7550M	3 x 4"	2 mil	1000	063636775513

### Clear Bag with Pouch

- Clear zip it bag with self-sealing and inside-fold specimen pouch

Item #	Size	Qty	UPC
MGP6X9	<b>C</b> 6 x 9"	1000	063636139698



### Error Prevention Bags

- Safety Step - Serves as a safety step for workers! If medication is in a bag the worker has to read and open to retrieve medication.
- Preprinted Message - Alert users to take precautions when handling contents.
- Closure - Reclosable zipper

Item #	Description	Size	Thickness	Qty	UPC
9527	High Alert	4 x 6"	2 mil	100	063636895273
9534	High Alert	6 x 8"	2 mil	100	063636895341
9535	High Alert	8 x 11"	2 mil	100	063636895358
9538	High Alert	3 x 12"	2 mil	100	063636795382
9537	For Intrathecal Use	6 x 9"	2 mil	100	063636779535



### Colour-Coded Message Bags

- Colour-coded instruction/safety precaution for easy identification
- Eliminates need for colour-coded or identification labels
- Efficient - Drop it in, zip it up, done! Save time-no labels to apply, no messages to write.
- Closure - Single-track reclosable zipper for details

Item #	Description	Size	Colour	Thickness	Qty	UPC
9520	Stat	4 x 6"	● Red	2 mil	100	063636895204
9521	Refrigerate	4 x 6"	● Blue	2 mil	100	063636895211
9522	PRN	4 x 6"	● Orange	2 mil	100	063636895228

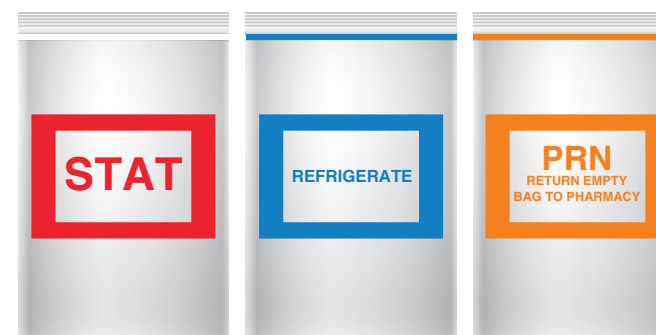



AMBER BAGS ARE IDEAL FOR LIGHT-SENSITIVE MEDICATION

Important information?  
Document it on these SELF-SEALING Bags. Tear off the receipt and then seal them up!

**Self-Sealing Bags with Tear-Off Receipt**

- Write-On Area - Eliminates the need to handwrite messages or apply labels to the bag.
- Perforated Tear-Off Receipt - For documentation
- Closure - Self-Sealing

Item #	Size	Colour	Thickness	Qty	UPC
7514	A 4 x 5.5"	○ Clear	1 1/2 mil	100	063636775148
7526*	B 6.5 x 7.75"	○ Clear	1 1/2 mil	100	063636775261
7520*	C 4 x 9.5"	○ Clear	1 1/2 mil	100	063636875206
7524	6.5 x 10"	○ Clear	1 1/2 mil	100	063636775247
7518*	D 3.75 x 12.75"	○ Clear	1 1/2 mil	100	063636775186
17499*	E 10.5 x 2.5"	○ Clear	1 1/2 mil	100	063636775223
17859	F 3.75 x 6.35"	● Amber	1 1/2 mil	100	063636178598
17860	6.5 X 10"	● Amber	1 1/2 mil	100	063636178604
17861*	G 15 x 3"	● Amber	1 1/2 mil	100	063636178611

\*Ideal size for syringes



**Self-Sealing Crash Cart Bags**

- Self-sealing, tamper evident – simply remove paper strip at top to access adhesive; fold over to seal bag
- Bags can be easily opened by tearing the highlighted perforations - ideal for quick access or code situations
- A tear in the bag indicates prior emergency or tampering
- 2 mil thick
- 20 per package



Item #	Description	Perforation	Dimensions (W x H)	Colours	UPC
1714	Security Bags for Deep Metro® Lifeline™ & Waterloo® CCB	1 center	31 x 21 1/2"	Clear	063636717148
19840	Amber Security Bags for Deep Metro® Lifeline™ & Waterloo® CCB	1 center	31 x 21 1/2"	Amber	063636198404
7512	Security Bags for Full-Size CCB	1 center	29 x 20"	Clear	063636775124
20501	A Amber Security Bags for Full-Size CCB	"H"	29 x 30"	Amber	063636205010
7505	Security Bags for Full-Size CCB	"H"	29 x 20"	Clear	063636775056
7515	Security Bags for Full-Size CCB	1 center, 1 end	29 x 20"	Clear	063636775155
7509	Security Bags for Full-Size CCB w/ Blue Border	1 center, 1 end	29 x 20"	Clear/Blue	063636775094
7510	Security Bags for Full-Size CCB w/ Red Border	1 center, 1 end	29 x 20"	Clear/Red	063636775100
7568B	Security Bags for Full-Size CCB Blue or Red	1 center, 1 end	29 x 20"	Blue	063636075682
7568R	Security Bags for Full-Size CCB Blue or Red	1 center, 1 end	29 x 20"	Red	063636756888
7506	Amber Security Bags for Full-Size CCB	1 center, 1 end	29 x 20"	Amber	063636775063
7534	Attn: Pediatrics Only Amber Security Bags for Full-Size CCB	1 center, 1 end	29 x 20"	Amber	063636075347
7535	Attn: Adult Only Amber Security Bags for Full-Size CCB	1 center, 1 end	29 x 20"	Amber	063636075354
7517	B Security Bags for Half-Size CCB	1 center	22 x 14"	Clear	063636775179
7502	Amber Security Bags for Half-Size CCB	1 center, 1 end	22 x 14"	Amber	063636775025
7500	Security Bags for Blue Bell CCB	1 center	18 1/2 x 15 1/2"	Clear	063636775001
7503	Security Bags for Top Compartment Metro® Lifeline™ CCB	1 center	21 1/2 x 20"	Clear	063636775032

Cart Box Item #	Security Bag Item #															
	1714	19840	7512	20501	7505	7515	7509	7510	7568	7506	7534	7535	7517	7502	7500	7503
Shallow CC Box 1870-01, 3215			✓		✓	✓	✓	✓	✓	✓	✓	✓				
Deep CC Box 1875-01, 3219	✓	✓														
Full-Size CC Box 1814 & 1867			✓	✓	✓	✓	✓	✓	✓	✓	✓	✓				
Third-Size CC Box 3150													✓	✓	✓	
Half-Size CC Box 3020, 3013, 3131													✓	✓	✓	
Metro Top Compartment CC Box 3057 & 3211																✓

### Hanging Prescription Bags

- Simplify prescription organization and retrieval
- Made of tough, clear 4 mil plastic for extreme durability
- Fits on any rod with a diameter of 1 cm or smaller

Item #	Size (W x H)	Qty	UPC
17540 <b>A</b>	10 1/2 x 7 1/2"	10	063636175405
17541	12 x 9"	10	063636175412
17542	14 x 12 1/2"	10	063636175429

### Wall Rack for Prescription Bags

- Simple solution to prescription organization
- Saves time, improves accuracy and enhances customer satisfaction
- Aluminum frame is 3 ft. wide and holds five 1 cm thick rods
- Each rod holds approximately 8-10 bags per foot or as many as 150 bags per rack
- Easy assembly, all hardware included
- Measures: 36" W x 57 1/2" H x 7 1/2" D
- Use with hanging bags and ID tags (sold separately)

Item #	Description	Qty	UPC
17543	Wall Rack for Prescription Bags	1 frame, 5 rods	063636175436
17544 <b>A</b>	Green ID Tags	25	063636175443



### Blue Refrigerate Zippit Bag

- Preprinted Message - Alert users to temperature sensitive contents
- Closure - Reclosable zipper

Item #	Size (W x H)	Thickness	Qty	UPC
7629-10 <b>C</b>	5 x 8"	2.5 mil	100	063636876296
18239	3 x 5"	2.5 mil	100	063636182397

### Chemo Waste Bags

- Safe Disposal - Use chemo waste bags to safely and economically dispose of chemo waste
- Closure - Use security seals
- Measures: 23 x 41 1/2" (opens to 31")

Item #	Capacity	Size	Thickness	Qty	UPC
18824	12-16 Gallon	25 x 34"	4 mil	50	063636188245
9617-10 <b>A</b>	20 gallon	23 x 41 1/2"	4 mil	100	063636896171
20199	20 Gallon	23 x 41 1/2"	4 mil	25	063636201999
20200	30 Gallon	31 x 41"	4 mil	25	063636202002



### Biohazard Waste Bags

- Stick on biohazard bags (Item # 9938) includes an adhesive strip to provide a secure closure, or use to stick onto cabinets, carts, walls, or other locations
- Small & extra large bags (Item # 7446 and 7445) have double-seam pleated sides that can carry heavy loads

Item #	Description	Size	Thickness	Qty	UPC
9938 <b>A</b>	Stick-on bag, 4" fold over flap	12 x 14"	2 mil	100	063636779382
7446	Small Biohazard Bag	11 1/4 x 14 1/2"	1 1/2 mil	50	063636774462
7445 <b>B</b>	Extra-large Bag, 33 gallons	20 x 39"	4 mil	25	063636774455

### Chemotherapy Transport & Batch Bags

- Heavy-duty clear reclosable bags provide a secure closure
- "Caution Chemotherapy Drug" yellow labelling

Item #	Size	Thickness	Qty	UPC
CT6X9	6 x 9"	4 mil	100	063636140694
CT6X9M	6 x 9"	4 mil	1000	063636146900
CT12X15	12 x 15"	4 mil	100	063636140250
CT12X15M	12 x 15"	4 mil	1000	063636112158



### Chemo Wipe Bags™

- Absorbent - Chemo Bag and Wipe is an absorbent wipe and heavy-duty hazardous waste disposal bag in one. Easily clean chemotherapy and cytotoxic chemical spills and safely dispose of hazardous waste without using large amounts of disposable towels that can spread germs. An adhesive seal ensures total containment and reduces the risk for cross-contamination when used with protective gloves in hospitals and healthcare settings.
- Ambidextrous - Yellow wiping bag has an ambidextrous built-in mitt to provide superior maneuverability and infection control. Just insert gloved hand, wipe up spill, turn inside out and seal! Sealed bag is ready to be disposed of in an approved waste container.
- Capacity - approximately 1 gallon
- Closure - adhesive seal

Item #	Size	Thickness	Qty	UPC
20192	11 1/2 x 12"	2 mil	20	063636201920

### Chemobloc™ Safelock Drug Transport Bags

- Provides safe storage and transport of cytotoxic medications
- Reclosable with a single track zipper closure
- Write on area for patient information

Item #	Description	Thickness	Qty	UPC
9490	<b>A</b> 6 x 9"	4 mil	100	063636794903
9491	<b>B</b> 12 x 15"	4 mil	250	063636794910



### Chemotherapy Disposal Bags

- Versatile - Use to transport, store and dispose of items used in chemotherapy prep or administration.
- Closure - Reclosable zipper

Item #	Size	Thickness	Qty	UPC
9516	9 x 12"	4 mil	100	063636795160
9516M	9 x 12"	4 mil	1000	063636779511
9517	12 x 15"	4 mil	100	063636795177
9517M	12 x 15"	4 mil	1000	063636799571

### Biohazard Zip It Bags

- Reclosable zip bag with pouch

Item #	Size	Qty	UPC
BHZ6X9	<b>A</b> 6 x 9"	1000	063636141691



### Biohazard Specimen Bags

- Easy Access - Bags can be torn open in the tearzone® for safe and easy access. There are no perforations to compromise the integrity of the bag.
- Closure - Reclosable zipper

Item #	Description	Size	Thickness	Qty	UPC
9514	<b>B</b> Biohazard Specimen	8 x 10"	2 mil	100	063636795146
9515	<b>C</b> Biohazard "STAT"	6 x 9"	2 mil	100	063636795153
9513	<b>D</b> Biohazard Specimen	6 x 9"	2 mil	100	063636795269

### Hazardous Drug Bags

- Closure - Single-track reclosable zipper
- Safe Transport - Clear bags with preprinted warnings keep contents visible during transport and raise awareness for hazardous drug contents. Thickness adds another layer of protection
- Quantity: 100

Item #	Description	Size	Thickness	UPC
20414	<b>A</b> Hazardous Drug Transport Bags	4 x 6"	4 mil	063636204143
20415	Hazardous Drug Transport Bags	12 x 15"	4 mil	063636204150
18488	<b>B</b> Caution Hazardous Drug (RCRA) Bags	4 x 6"	2 mil	063636184889
20868	Caution Hazardous Drug (RCRA) Bags, Black	6 x 9"	2 mil	063636208684



### Insulin Pen Bag, 8 x 2

- Pre-Printed Message: Bag reads "Insulin Pen" and provides space to write the patient's name.
- Insulin Pen Storage: Patient-specific insulin pens can be easily identified and safely stored in this preprinted reclosable bag.
- Thickness: 2-mil
- Closure: Single-track reclosable zipper
- Quantity: 100 per pack
- Dimensions: 8"W x 2"H

Item #	UPC
18503	<b>C</b> 063636185039

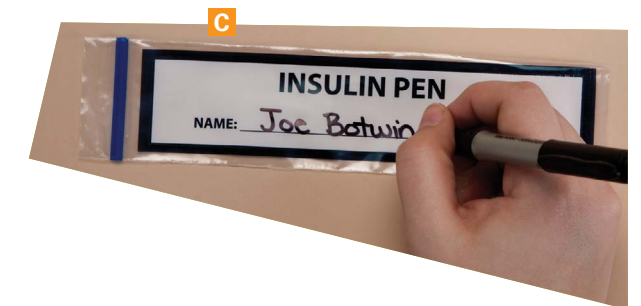

### Leakproof Chemo Bags

- 18487, 18220 Caution Hazardous Drug Bags
- 20289, 20290 hazardous Drug Leakproof Bags
- Prevent Leakage: Patented liquid-tight closure prevents leaks and the risk for contamination
- Seal & Reveal: Press and Close system seals bag; ES open TearZone replaces hard-to-open scores and perforations that can leak
- Document Ready: Disposable bags include a pocket for important paperwork

Item #	Description	Size	Thickness	Qty	UPC
18487	<b>D</b> Caution Hazardous Drug Bags	4 x 6"	2 mil	100	063636184872
18220	Caution Hazardous Drug Bags	9 x 12"	2 mil	100	063636182205
20289	<b>E</b> Hazardous Drug Leakproof Bags	6 x 9"	2 mil	100	063636202897
20290	Hazardous Drug Leakproof Bags	12 x 15"	2 mil	100	063636202903

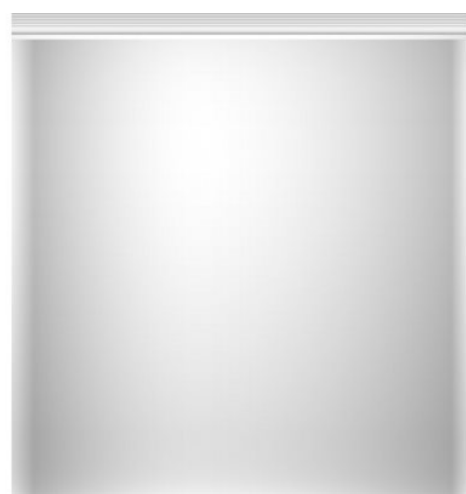

Anti UV Ziplock Bags



Anti UV Bag with Perm Tape



Anti-UV IV Bag, Non-Reclosable

**Clear Anti-UV Bags**

- Thickness: 2 mil
- Reusable
- Used for medication delivery: Clearly see contents inside the bag

Item #	Description	Size (Inch)	Zipper	Perforated	Qty	UPC
CL4X4ZIP	LDPE Clear Anti-UV Ziplock Bag	4 x 4	✓	-	1000	063636345679
CL2X2ZIP	LDPE Clear Anti-UV Ziplock Bag	2 x 2	✓	-	1000	063636784300
CL3X4ZIP	LDPE Clear Anti-UV Ziplock Bag	3 x 4	✓	-	1000	063636907891
CL4X6ZIP	LDPE Clear Anti-UV Ziplock Bag	4 x 6	✓	-	1000	063636578909
CL4X8ZIP	LDPE Clear Anti-UV Ziplock Bag	4 x 8	✓	-	1000	063636457860
CL5X8ZIP	LDPE Clear Anti-UV Ziplock Bag	5 x 8	✓	-	1000	063636457877
CL6X6ZIP	LDPE Clear Anti-UV Ziplock Bag	6 x 6	✓	-	1000	063636902346
CL6X8ZIP	LDPE Clear Anti-UV Ziplock Bag	6 x 8	✓	-	1000	063636789015
CL6X9ZIP	LDPE Clear Anti-UV Ziplock Bag	6 x 9	✓	-	1000	063636785642
CL8X8ZIP	LDPE Clear Anti-UV Ziplock Bag	8 x 8	✓	-	1000	063636456719
CL9X12ZIP	LDPE Clear Anti-UV Ziplock Bag	9 x 12	✓	-	1000	063636789350
CL10X12ZIP	LDPE Clear Anti-UV Ziplock Bag	10 x 12	✓	-	1000	063636789060
CL10X13ZIP	LDPE Clear Anti-UV Ziplock Bag	10 x 13	✓	-	1000	063636451097
CL12X12ZIP	LDPE Clear Anti-UV Ziplock Bag	12 x 12	✓	-	1000	063636452308
CL13X15ZIP	LDPE Clear Anti-UV Ziplock Bag	13 x 15	✓	-	1000	063636764562
CL2X3UVIV	LDPE Clear Anti-UV IV Bag, Non-Reclosable	2 x 3	-	-	1000	063636485436
CL3X14UVIV	LDPE Clear Anti-UV IV Bag, Non-Reclosable	3 x 14	-	-	1000	063636789213
CL5X8.5UVIV	LDPE Clear Anti-UV IV Bag, Non-Reclosable	5 x 8 1/2	-	-	1000	063636234515
CL6X10UVIV	LDPE Clear Anti-UV IV Bag, Non-Reclosable	6 x 10	-	-	1000	063636452384
CL8X14UVIV	LDPE Clear Anti-UV IV Bag, Non-Reclosable	8 x 14	-	-	1000	057800067610
CL10X18UVIV	LDPE Clear Anti-UV IV Bag, Non-Reclosable	10 x 18	-	-	1000	063636078911
CL2.5X8.5UV	Anti UV Bag, Clear With Perm Tape	2 1/2 x 8 1/2	-	-	1000	063636459871
CL5X4UV	Anti UV Bag, Clear With Perm Tape	5 x 4	-	✓	1000	063636091231
CL5X6UV	Anti UV Bag, Clear With Perm Tape	5 x 6	-	✓	1000	063636907839
CL6X8.5UV	Anti UV Bag, Clear With Perm Tape	6 x 8 1/2	-	✓	1000	063636658717
CL8X10UV	Anti UV Bag, Clear With Perm Tape	8 x 10	-	✓	1000	063636457853
CL12X12UV	Anti UV Bag, Clear With Perm Tape	12 x 12	-	✓	1000	063636548919



A



B



C

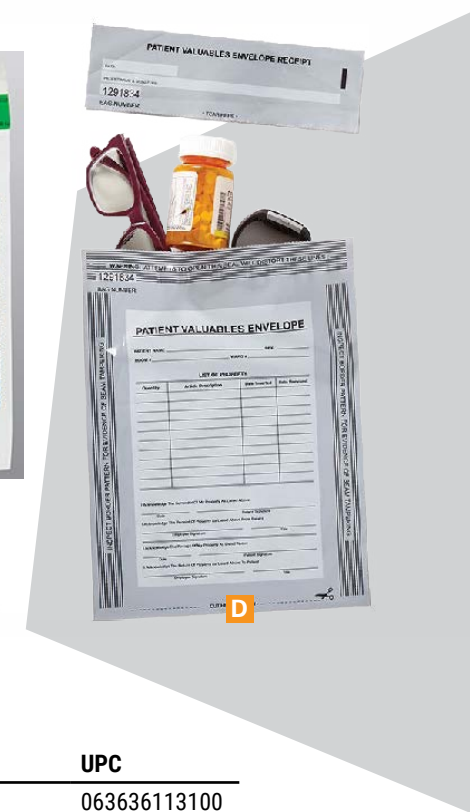

D

**Tamper Evident Bags**

- Thickness: 2 3/4 mil
- Special Features:
  - Dual serial numbers and a tear-off receipt provide traceability
  - Permanent pressure-sensitive adhesive. Flap reads 'Void' if opened after sealed.

Item #	Description	W x H	Colour	Qty	UPC
11310	<b>A</b> Personal Property Bags	8 x 10"	Clear	25/pkg	063636113100
11311	Personal Property Bags	8 x 10"	Clear	250/roll	063636113193
11312	Personal Property Bags	9 x 12"	Clear	25/pkg	063636113124
11313	Personal Property Bags	9 x 12"	Clear	250/roll	063636313135
11308	<b>B</b> Evidence/Chain of Custody Bags	9 x 12"	Clear	25/pkg	063636113087
11309	Evidence/Chain of Custody Bags	9 x 12"	Clear	250/roll	063636113094
10456	Patient's Medicine Inventory Bags	6 x 9"	Clear	25/pkg	063636104566
10446	Patient's Medicine Inventory Bags	6 x 9"	Clear	250/roll	063636104467
10457	Patient's Medicine Inventory Bags	9 x 12"	Clear	25/pkg	063636104573
10447	Patient's Medicine Inventory Bags	9 x 12"	Clear	250/roll	063636104474
19749	Patient's Medicine Inventory Bags	12 x 14"	White	25/pkg	063636197490
19749-31	Patient's Medicine Inventory Bags	12 x 14"	White	250/roll	063636197483
19750	Patient's Medicine Inventory Bags	12 x 14"	Clear	25/pkg	063636197506
19750-31	Patient's Medicine Inventory Bags	12 x 14"	Clear	250/roll	063636197513
10458	Patient's Medicine Inventory Bags	9 x 12"	White	25/pkg	063636104580
10448	<b>C</b> Patient's Medicine Inventory Bags	9 x 12"	White	250/roll	063636104481
20231	<b>D</b> Patient Valuables Bags	9 x 12"	Grey/White	100/pkg	06363697520
10472	Alert Void Security Bags	8 x 10"	Clear	25/pkg	063636104726
10440	Alert Void Security Bags	8 x 10"	Clear	250/roll	063636104405
10473	Alert Void Security Bags	8 x 10"	White	25/pkg	063636104733
10441	Alert Void Security Bags	8 x 10"	White	250/roll	063636104412
10475	Alert Void Security Bags	9 x 12"	White	25/pkg	063636104757
10443	Alert Void Security Bags	9 x 12"	White	250/roll	063636104436
10474	Alert Void Security Bags	9 x 12"	Clear	25/pkg	063636104740
10442	Alert Void Security Bags	9 x 12"	Clear	250/roll	063636104429
10477	Alert Void Security Bags	10 x 14"	White	25/pkg	063636104771
10445	Alert Void Security Bags	10 x 14"	White	250/roll	063636104450
10476	Alert Void Security Bags	10 x 14"	Clear	25/pkg	063636104764
10444	Alert Void Security Bags	10 x 14"	Clear	250/roll	063636104443
10478	Standard Security Bags	8 x 10"	White	25/pkg	063636104788
10479	Standard Security Bags	8 x 10"	White	500/roll	063636104795

### ExactaMed™ Oral Dispensers

- Self-righting caps included (will not fit luer needle)
- Safe for neonatal, pediatric and adult use
- Unique tip design prevents wrong-route administration
- Chemically inert to provide stability for drug storage and transport
- Enlarged numbers for quick and accurate volume identification
- Includes distinct bilingual labeling “For Oral Use Only”
- Amber dispensers for light-sensitive drug applications



#### Clear Oral Dispensers

Item #	Capacity	Increments	Colour	Qty	UPC (063636)
10200	0.5 mL	0.01 mL	Clear	100	102005
200	0.5 mL	0.01 mL	Clear	500	502003
10201	1 mL	0.01 mL	Clear	100	102012
201	1 mL	0.01 mL	Clear	500	502010
801	1 mL	0.01 mL	Clear	2000	208011
901	1 mL	0.01 mL	Clear	3000	090135
10203	3 mL	0.01 mL	Clear	100	102036
203	3 mL	0.01 mL	Clear	500	502034
803	3 mL	0.01 mL	Clear	2000	208035
10205	5 mL	0.2 mL	Clear	100	102050
205	5 mL	0.2 mL	Clear	500	502058
805	5 mL	0.2 mL	Clear	2000	208059
10210	10 mL	0.2 mL	Clear	100	102135
210	10 mL	0.2 mL	Clear	500	702106
710	10 mL	0.2 mL	Clear	1800	117191
810	10 mL	0.2 mL	Clear	2000	208103
10220	20 mL	1 mL	Clear	100	102203
1221	60 mL	1 mL	Clear	75	712211

#### Amber Oral Dispensers

Item #	Capacity	Increments	Colour	Qty	UPC (063636)
11200	0.5 mL	0.01 mL	Amber	100	112004
1200	0.5 mL	0.01 mL	Amber	500	512002
11201	1 mL	0.01 mL	Amber	100	112011
1201	1 mL	0.01 mL	Amber	500	512019
1801	1 mL	0.01 mL	Amber	2000	218010
1901	1 mL	0.01 mL	Amber	3000	190125
11203	3 mL	0.01 mL	Amber	100	112035
1203	3 mL	0.01 mL	Amber	500	512033
1803	3 mL	0.01 mL	Amber	2000	218034
1903	3 mL	0.01 mL	Amber	2500	190309
11205	5 mL	0.2 mL	Amber	100	112059
1205	5 mL	0.2 mL	Amber	500	512057
11605	5 mL	0.2 mL	Amber	1500	116156
1805	5 mL	0.2 mL	Amber	2000	218058
11210	10 mL	0.2 mL	Amber	100	112103
1210	10 mL	0.2 mL	Amber	500	512101
11710	10 mL	0.2 mL	Amber	1800	117191
1810	10 mL	0.2 mL	Amber	2000	218102
11220	20 mL	1 mL	Amber	100	112202
1222	60 mL	1 mL	Amber	25	712228

### ExactaMed™ Oral Dispensers Bedside Packs

- Self-righting tip caps sold separately
- Packaged in bags of 10

Item #	Capacity	Increments	Qty	UPC
301	1 mL	0.01 mL	500	063636503017
303	3 mL	0.01 mL	500	063636503031
305	5 mL	0.2 mL	500	063636503055
310	10 mL	0.2 mL	500	063636503109
320	20 mL	1 mL	100	063636103200



### Oral Dispensing Syringe w / Tip Cap

- Clear graduation markings for accurate medication delivery
- Not made with natural rubber latex
- Special tip design will not accept Luer connectors, preventing medication errors and the accidental intravenous injections of oral liquids
- Includes protective tip cap for transportation with no spillage
- User-friendly gradation in millimeters

Item #	Capacity	Increments	Qty	Colour	UPC
S10205	5 ml	1 ml	100	Clear	063636234676
S205	5 ml	1 ml	500	Clear	063636923433
S10210	10 ml	1 ml	100	Clear	063636321017
S210	10 ml	1 ml	500	Clear	063636321000
S11210	10 ml	1 ml	100	Amber	063636789879
S1210	10 ml	1 ml	500	Amber	063636784638



### Tip Caps, Self-Righting

- Fits all Exacta-med oral dispensers
- Made out of high-density polyethylene
- Latex-free

Item #	Qty	UPC
50300	100	063636702045



### Tamper Evident Syringe Seals with Pre-Printed Messages

- Pre-printed with “Do Not Use if Seal Is Broken” in red
- Cannot be re-attached once removed
- Packaged in a dispensing box
- See more tamper evident solutions on pages 61



Item #	Colour	Size	Length	Qty	UPC
7997	<b>A</b> Silver	Short	3 <sup>5</sup> / <sub>8</sub> ”	1000	063636879976
7998	<b>B</b> Silver	Long	4 <sup>1</sup> / <sub>4</sub> ”	1000	063636879983
8001	<b>C</b> White	Short	3 <sup>1</sup> / <sub>2</sub> ”	1000	063636880019

### Press-In Bottle Adapters

- Converts a standard bottle into a dispensing device
- Plastic adaptors fit into bottle openings and allow syringes to be easily inserted and filled without a mess
- Bottle caps can still be secured with the adaptor in place
- Non-sterile

Item #	For Bottle Neck	Qty	UPC
17282	<b>A</b> 20 mm	20	063636172824
17282-10	20 mm	100	063636272821
17283	<b>B</b> 24 mm	20	063636172831
17283-10	24 mm	100	063636272838
17284	28 mm	20	063636172848
17284-10	28 mm	100	063636272845
17285	33 mm	20	063636172855
17285-10	33 mm	100	063636272852
19392	22 mm	50	063636193928
19393	24 mm	50	063636193935
19394	28 mm	50	063636193942



### SealSafe™ Self-Sealing Pierced Bottle Adapters

- Prevent Contamination - Reseal quickly to provide a safe, clean and consistent seal. Helps prevent evaporation, spills and contamination
- Easy Conversion - Non-sterile adapters quickly and easily convert standard prescription bottles into filling devices Compatible with most brands of oral dispensers
- Pierced Closure - Recommended for use with liquids slightly below, at or above the consistency of water
- Material - Thermoplastic elastomer and a proprietary blend of polypropylene

Item #	For Bottle Neck	Qty	UPC
20227	<b>C</b> 20 mm	20	063636202279
20227-31	20 mm	200	063636202274
20228	20 mm	20	063636202286
20228-31	20 mm	200	063636202280
20229	24 mm	20	063636202293
20229-31	24 mm	200	063636202996
20230	28 mm	20	063636202309
20230-31	28 mm	200	063636202330



### StaySafe™ Self-Sealing Bottle Closure

- Converts a standard bottle into a dispensing device
- Self-sealing closure maximizes safety and accuracy when dosing liquid medications
- Helps prevent evaporation, spills and contamination
- Closure is easily penetrated by oral dispenser and reseals when syringe is removed
- Prevents waste - allows access to the last drop
- Bottle caps and standard child resistant caps can still be secured with the adaptor in place
- Non-sterile

Item #	For Bottle Neck	Qty	UPC
17727	<b>D</b> 24 mm	20	063636177270
18761	28 mm	20	063636187606

### Tamper Evident Oral Tip Caps

- Three-part plastic cap for Baxa Exacta-Med® and Comar® oral dispensers
- Secure, non-sterile cap requires user to break off outer sleeve in order to dispense medication
- Tamper-indicating red ring remains in place, indicating outer sleeve has been removed
- Cap is made of polypropylene, sleeve of polystyrene plastic
- Latex free

Item #	Dispenser Compatibility	Qty	UPC
52300	Baxa Exacta-Med®	100	063636723002



### Tamper-Evident Luer Lock Tip Caps

- Three-part plastic cap used to indicate tampering on a luer lock syringe
- Sterile and non-pyrogenic in unopened, undamaged package
- Latex free
- Packaged in trays of 10

Item #	Qty	Colour	UPC
64010	100	Red	063636840105
17360B	100	Blue	063636173609

### Luer Lock Tip Caps

- Tamper evident syringe cap improves medication security by clearly showing that the syringe is intact
- Red luer lock cap for standard luer lock syringes
- Made out of polypropylene
- Sterile
- Convenient - unique blister pack of 10 protects the sterility of unopened caps

Item #	Qty	UPC
65001	100/case, packaged individually	063636850012



### Sterile Female-Female Luer Lock Connector

- Easy Fill Solution - Sterile-packaged, Female-Female Luer Lock Connector connects to male luer, syringe, tube sets, repeating syringes, IV bag ports, etc., to create the perfect solution to fill dispensers from a luer connection.
- Sterile - Individual blister packaging protects the sterility of unopened connectors.

Item #	Qty	UPC
19158	100/case	063636191580

### Guarded Syringe Connector

- Female to female syringe connector
- Estimated 0.07 mL of fluid loss during transfer
- High quality adapter
- Individually packaged

Item #	Qty	UPC
52400	50	063636524005

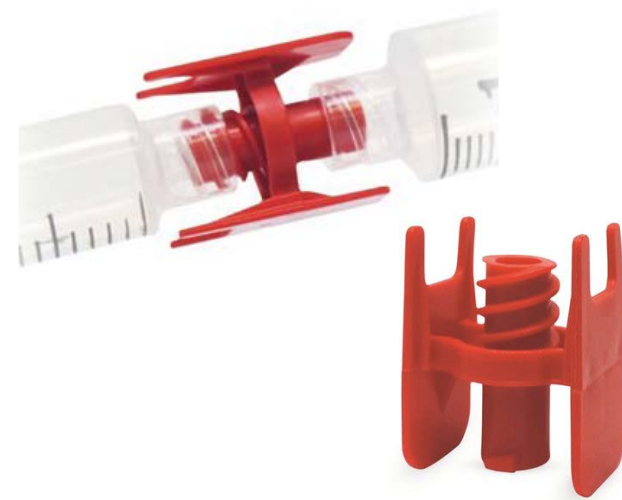

### Sterile Male-Male Luer Slip Adapter

- Packaged Sterile
- Pyrogen Free
- Individual Blister Packs

Item #	Qty	UPC (063636)
19156	50	063636191566



### Sterile Luer-Lock Syringe Caps

- Improve Productivity - Ideal for volume capping of syringes during compounding. Sterile packaging tray provides immediate access to 10 sterile caps and allows users to open 2 caps at a time without compromising the remaining caps.
- Compatibility - Fits all mL syringes.
- Color Options - Red & White. Specify colour when ordering.

Item #	Qty	UPC
19159	100/case	063636191597



### Dissolve-A-Dose, 15 mL

- Dissolve cut tablets or powder quicker and easier than the powder paper technique
- Adaptable cap allows medication to be drawn up into oral syringe for immediate administration or to add diluents

Item #	Size	Qty	UPC
5294	15 mL	50	063636505295

### Mark-A-Dose

- Clear pressure-sensitive adhesive label to mark on oral syringes or other graduated containers for a dosage regiment
- Made out of polyester film
- Latex free
- 1000 per package

Item #	Size	UPC
42900	A 2 x 1/2"	063636829001

### Universal Bottle Adapter

- Graduated plug with orifice and tethered closure that fits bottles with neck openings of 13 to 22 mm
- Use to fill oral syringes and medication dispensers
- Snap top plug fits orifice for storage
- Made out of thermoplastic elastomer
- 100 per package

Item #	UPC
12000	B 063636120009

### Locking Tip Cap

- Self-threading, securely locks onto a cathay syringe or catheter tip adapter
- Made of ABS plastic, latex free
- Sterile and non-pyrogenic when unopened
- 25 per package

Item #	UPC
67031	C 063636670313

### Adapta-Cap

- Converts a standard prescription bottle into a filling device
- Low-density polyethylene with tethered, reclosable cap for easy and mess-free syringe filling
- Available sizes fit most oral medication bottles, and fits all PharmaSystems® oral dispensers
- 28 mm are compatible with amber plastic and glass medicine bottles, see page 15, section B and D
- Provides air free filling by inversion of bottle assembly
- Latex-free, non-sterile, non-DEHP
- Available 25 or 100 per package, see options below

Bottleneck Size	Item # (25/pkg)	UPC	Item # (100/pkg)	UPC
A-18mm	D 51001-T	063636710019	51001	063636810016
B-20mm	51002-T	063636710026	51002	063636810023
D-24mm (for glass bottles)	51004-T	063636710040	51004	063636810047
E-28mm (short neck)	51005-T	063636710057	51005	063636810054
F-28mm (long neck)	51006-T	063636710064	51006	063636810061
M-24mm (for plastic bottles)	51013-T	063636710132	51013	063636810139

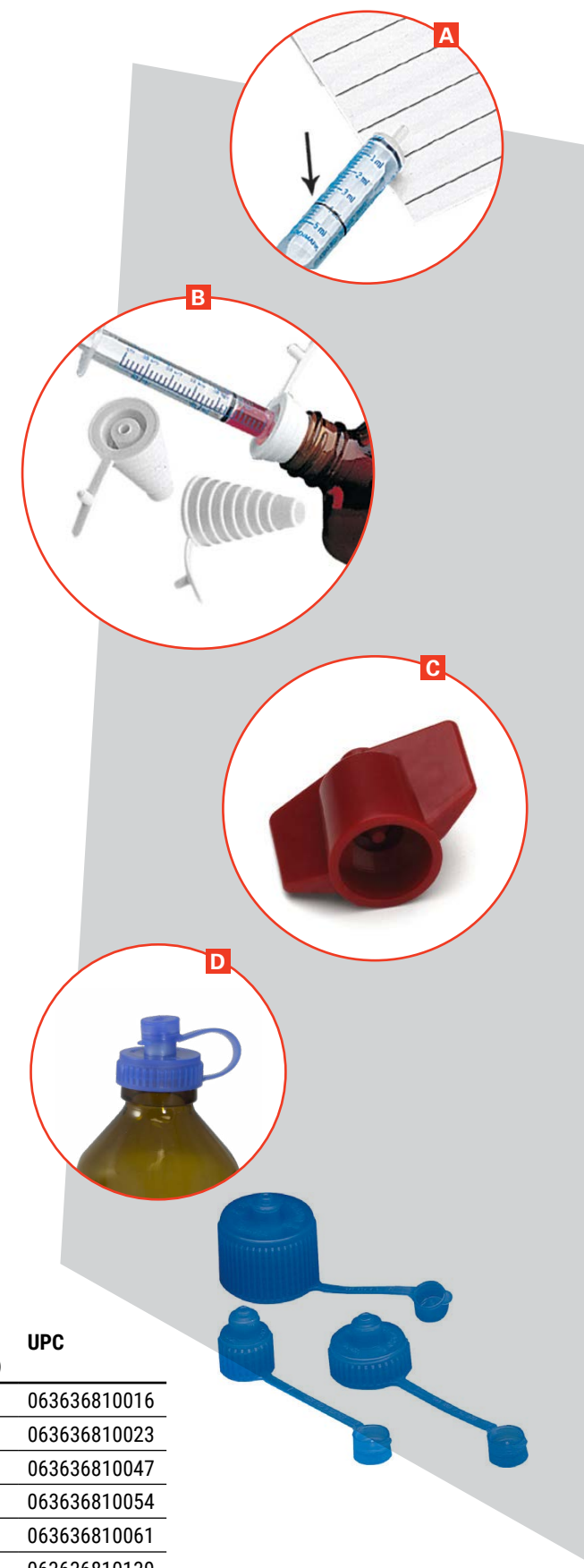

### Sterile Rapid Fill Connectors

- Luer lock-to-oral slip connection
- Connects to male luer or syringes, tube sets, repeating syringes, bag ports, etc.
- Flange facilitates contamination-free handling
- Made out of natural polypropylene
- 50 per package, packaged individually

Item #	Description	Colour	UPC
12703	Luer Lock-to-Oral Slip	○ Natural	063636127039
13701 <b>A</b>	Luer Lock-to-Luer Slip	● Blue	063636737016
13901	Luer-Lock-to-Luer Lock	● Red	063636739010
13915	Luer Lock-to-Luer Lock with Cap	● Red	063636739157

### Luer Lock-to-Oral Slip Connector

- Connect oral dispensers to luer filling devices such as syringes, from a pharmacy pump tube set, repeating syringe, or a large source
- Made out of clear polypropylene, latex-free
- Non-sterile
- 50 per package, packaged individually

Item #	UPC
12701 <b>B</b>	063636127015

### Sterile Luer Lock Universal Spike

- Sterile spike with a female luer lock connector
- Ideal for additions and withdrawals from IV bags or bottles
- Spike is made of ABS; vent is made out of hydrophobic filter, and sheath is made out of polyethylene, latex-free
- Sterile and non-pyrogenic in unopened package
- 20 per package

Item #	UPC
29 <b>C</b>	063636700294

### Luer Lock-to-Catheter Tip Adapter

- Sterile, polypropylene adapters with a female luer lock connector on one end and a male catheter tip on the other end
- Ideal to adapt luer lock connections for catheter and urethra tips
- Safely transport cytotoxic drugs in a securely capped standard luer lock syringe, then convert the syringe to a catheter tip for administration
- Sterile and non-pyrogenic in unopened package
- Latex-free

Item #	Qty	UPC
13601 <b>D</b>	50	063636736019

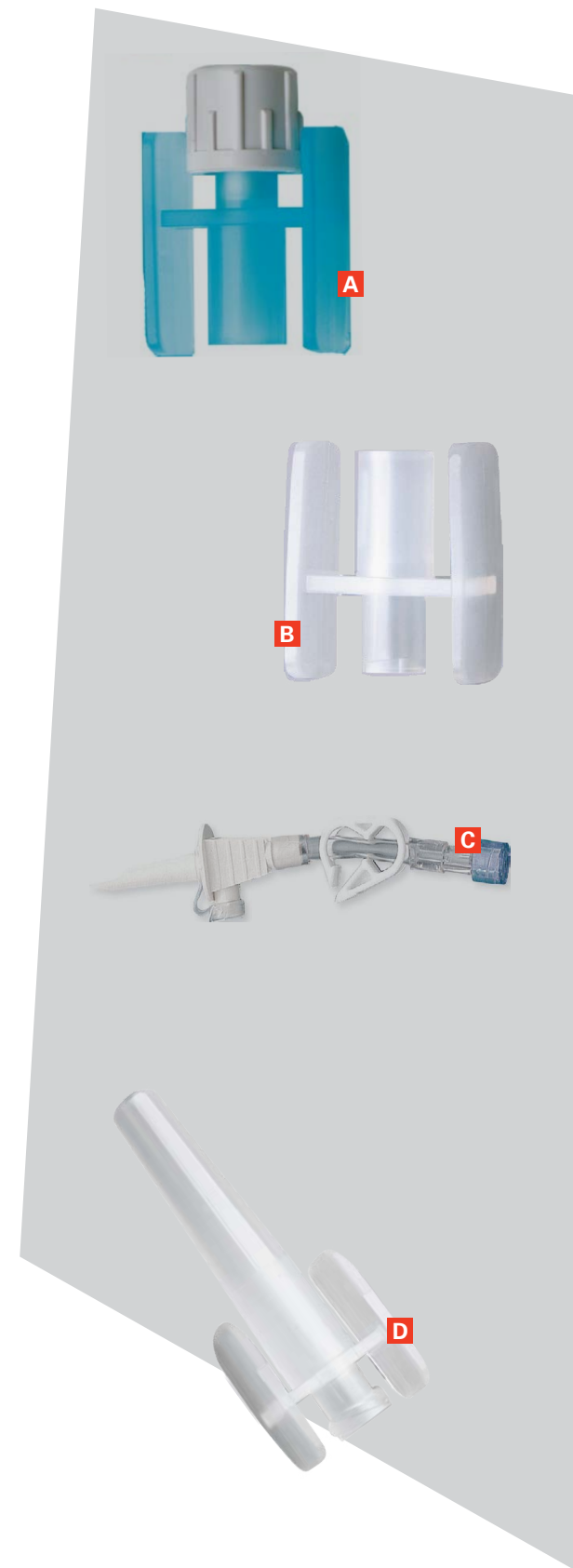

### CytoSafe Dispensing Pin

- Use for reconstitution or withdrawal of multidose vials
- Ideal for easy preparation and withdrawal of medicine
- Molded plastic spike with a 0.2 micron filtered vent, sheathed and tethered cap
- Silicone applied to spike for easier insertion and extraction
- Housing is made out of glass fiber-reinforced ABS, vent cap is made out of high-density polyethylene, filter material is made of Verspor-200R 0.2 micron - hydrophobic; and sheath is made out of polyethylene; latex free
- Sterile and non-pyrogenic in unopened package

Item #	Qty	UPC
49	50	063636700492

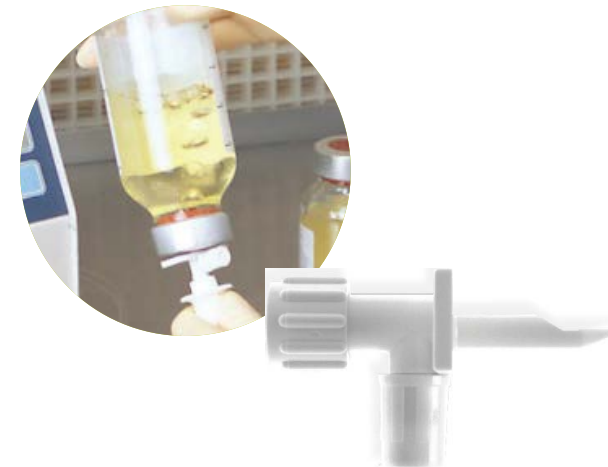

### Venting Needle, 20 gauge

- Sterile filtered venting needle designed for use by pharmacists and other specialists to evacuate drug containers during medication preparation and delivery
- Can be used with any vial or bottle
- 0.2 micron hydrophobic filter yellow transfer needle is compact and easy-to-handle
- 20 gauge x 1-1/2" stainless steel non-coring needle easily penetrates all stoppers with minimum risk of damage

Item #	Qty	UPC
18955	25	063636189556



### ExactaMed Dispensing Pin

- Ideal for vented additions and/or withdrawals of fluid from multidose vials
- Eliminate risk of air being drawn into solution - prevents air bubbles from being aspirated back into the syringe; with offset air inlet, it lets air in above the fluid
- Molded plastic spike with filtered vent, sheath and dust cap
- Pin housing and screw caps are made of ABS; sheath is made out of polyvinyl chloride; vent assembly housing is made out of polypropylene with a 3 micron acrylic copolymer membrane - hydrophobic and oleophobic vent; latex free
- Sterile and non-pyrogenic in unopened package
- 50 per package, packaged individually

Item #	Qty	UPC
47	50	063636700478



### 16G Two-Fer Needles, Sterile

- Thin-walled stainless steel needle glued into a vented luer-lock hub using UV-cured adhesive
- Functions as both a high-efficiency, non-curing needle and as an easy-to-use venting device
- Hubs are colour coded for identification
- Dual purpose needle - transfer liquids into closed vials without over pressurization of vial, transfers high-volume liquids using pumps and repeating syringes and withdraws solution from vials without creating negative pressure

Item #	Length	Qty	Colour	UPC
19003 <b>A</b>	1"	100/pack	Green	063636790035
16004 <b>B</b>	1/2"	100/pack	Purple	063636760045

### Aspirating Needle

- The sharp cannula is used to draw fluid for reconstruction or to pre-fill syringes prior to administration.
- Packaged Sterile
- Pyrogen Free
- Individual Blister Packs

Item #	Description	Qty	UPC
17046	19 guage x 3"	100	063636170462
17047	19 guage x 5"	100	063636170479
17056	16 guage x 3.5"	100	063636170561



### Spiked Plastic Fill Needle

- Pointed tip penetrates rubber stoppers for easy filling - attaches to a luer tip
- Vented to allow air to escape while filling
- Disposable
- Sterile

Item #	Qty	UPC
7723	100	063636777234



### Tamper Resistant Add-Port Cap

- Restricts access to the additive port on bags
- Positive lock seals once and cannot be reopened
- Non-sterile
- Body: Polypropylene

Item #	Qty	Colour	UPC
4858	100	Red	063636048587
4073	25	Blue	063636040734



### Chemo-Vent® Filtered Venting Needle

- Filtered venting needle designed for use when reconstituting and withdrawing cytotoxic anti-neoplastic agents
- The non-coring needle easily penetrates all stoppers with minimum risk of damage, while the hydrophobic filter maintains asepsis and prevents toxic, aerosolized materials from leaving the container during filling
- Red color coding to safely identify use with cytotoxic agents
- 0.2 micron hydrophobic filter
- 20 gauge x 1.5" non-coring, stainless steel needle (non-reactive to agents such as cis-platin)

Item #	Qty	UPC
18723	25	063636187231
18723-10	100	063636018726

### Syringe Filters, Sterile

- Designed for quality control during sterile drug preparation
- Ideal for preparing injectable drug products requiring rapid filtration and throughput with low protein binding and broad drug compatibility
- Features female and male luer lock connector
- Hydrophilic patented polyethersulfone membrane offers high fluid flow rates, lower extractables and durable strength
- Housing is made out of modified acrylic and membrane is made out of supor polyethersulfone; latex free
- Materials pass USP Class VI - 121 Plastic tests
- Fluid path is sterile and non-pyrogenic in unopened package
- 50 per package, packaged individually

Item #	Description	Qty	UPC
21050	25 mm 5 micron	50	063636710507
24642	32 mm 0.2 micron	50	063636246242
21002	25 mm 0.2 micron	50	063636210021



### Ampule Opener

- Small cutting blade inside scores the ampule stem to help ensure a clean break
- Will work with most sizes of ampules
- Reduces the chance of finger cuts and injuries
- Reusable, can be sterilized
- Measures 2 1/2" L x 3/4" D

Item #	Qty	UPC
7371	1	063636873714

### Ampule Crackers

- Non-breakable plastic fracture and safety collar, specifically designed to aid in the opening of pre-scored glass ampules
- Simply slip over the top of the pre-scored portion of the ampule, snap it, and discard both the ampule top and safety collar to prevent cross contamination
- Disposable - eliminates need for sterilization

Item #	Size	Qty	UPC
7372	1-4 mL Ampules	100	063636773724
7374	5-10 mL Ampules	100	063636773748



### Disposable Ampule Breaker

- Ampules can be safely opened by snapping the top of the ampule breaker to the side; thus breaking the top of the ampule off at the neck of the bottle - top of the ampule can then be discarded along with the ampule breaker
- Reduces the chance of finger cuts and cross contamination
- Disposable - eliminates need for sterilization
- Made out of polypropylene plastic
- Measures 2 x 1 1/4"

Item #	Qty	UPC
10262	100	063636102623

### Fluid Transfer Tube Set with Vented Spike

- Vented inlet spike and luer lock outlet for filling sterile oral dispensers, luer syringes, vials, elastomeric infusers, minibags and cassettes from IV bags or bottles of solution
- Use in conjunction with rapidfill connectors, dispensing pins or 16 gauge TwoFer Needles
- Tubing made of PVC; connectors made of ABS and clamp made of homopolymer



Item #	Qty	UPC
11	10	063636000110



### Fluid Transfer Tube Set

- Male luer lock connections allow needle, luer lock spike or dispensing pin to be used at the inlet and outlet
- Tubing made of PVC, connectors made of ABS and clamp made of homopolymer
- Individually packaged, 10 per case

Item #	Pack Qty	Case Qty	UPC
21	1	10	063636001216

### Kwik-Vial™

- Amber, light-resistant plastic vials with durable heat-sealed foil lids, ideal for unit dose packaging, delivery and administration of oral liquid medications
- Factory sealed, foil laminate with peel-back top (non-sterile)
- Plastic tray keeps vials clean, separated and in ideal fill position
- Latex-free, made of high-density polyethylene; sealing plug is made out of polypropylene; laminated foil lid is 3.9 mil thick
- Labels are not included. Compatible labels are item #20475

Item #	Size	Qty	UPC
30015	15 mL	300 (50/tray)	063636300159
30030	30 mL	300 (50/tray)	063636300302



### Kwik-Vial™ Plug Dispenser

- Allows for rapid, clean placement of Kwik-Vial™ Plug
- Dispenser holds enough plugs to fill a complete tray of 50 vials

Item #	UPC
30009	063636300098



### Kwik-Vial™ Filling Extension

- Attaches to any male luer fitting to facilitate vial filling
- Extends into filling hole of Kwik-Vial™ to help guide fluid path
- Made out of polyvinyl chloride; latex-free
- Non-sterile

Item #	Qty	UPC
30008	50	063636300081

### Repeater Pump

- Designed to transfer fluids at volumes from 0.2 ml to 9.999 ml at flow rates up to 13.5 ml per second with a 16-gauge needle
- Drawback feature to relieve line pressure and prevent fluid drippage between fills
- Interval mode to avoid pressing start/stop repeatedly
- Powerful motor with 27 speed combinations (including reverse mode), enabling it to pump viscous fluids and fill elastomeric infusers
- 20-cell memory storage for commonly used pump settings to standardise repeated applications

Item #	Description	UPC
99	Repeater Pump	063636990008
30	Repeater Pump Stand	063636011307
32	Repeater Pump Bag Pole	063636011321
99-PED	Repeater Pump Foot Pedal	063636000998



### ENFit® Syringes

- **Prevent Misconnections:** ENFit® tip requires a twisting motion to connect. This new design only fits enteral devices to help prevent misconnections.
- **Easy to read:** Syringes feature 1 ml graduated markings to help improve dosing accuracy.
- **Packaging:** Syringes include tip caps. 60 ml syringes are packaged in a reclosable IV pole bag.



Item #	Description.	Size.	Colour	Qty	UPC
19798-31	Low Dose ENFit Syringe	1 ml	Clear	50	063636197988
19798-500	Low Dose ENFit Syringe	1 ml	Clear	500	063636197995
19799-31	Low Dose ENFit Syringe	3 ml	Clear	50	063636197919
19799-500	Low Dose ENFit Syringe	3 ml	Clear	500	063636197391
19801-31	ENFit Syringe	10 ml	Clear	50	063636198015
19801-500	ENFit Syringe	10 ml	Clear	500	063636098018
20306-50	Low Dose ENFit Syringe	1 ml	Amber	50	063636203061
20306-500	Low Dose ENFit Syringe	1 ml	Amber	500	063636203009
20307-50	Low Dose ENFit Syringe	3 ml	Amber	50	063636203078
20307-500	Low Dose ENFit Syringe	3 ml	Amber	500	063636203771
20308-50	ENFit Syringe	5 ml	Amber	50	063636203085
20308-500	ENFit Syringe	5 ml	Amber	500	063636203887
20309-50	ENFit Syringe	10 ml	Amber	50	063636203092
20309-500	ENFit Syringe	10 ml	Amber	500	063636203993
20310-50	ENFit Syringe	20 ml	Amber	50	063636203108
20310-500	ENFit Syringe	20 ml	Amber	200	063636203122
20311	ENFit Syringe	3 ml	Amber	50	063636203115
20311-500	ENFit Syringe	35 ml	Amber	500	063636203313
20318	ENFit Syringe	60 ml	Amber	50	063636203184
20318-500	ENFit Syringe	60 ml	Amber	500	063636203894
19960	Tamper Evident Tip Caps for ENFit Syringes			100	063636199609
19960-10	Tamper Evident Tip Caps for ENFit Syringes			1000	063636019969

### Enteral Syringe with ENFit® Connector, Non-Sterile

- Supports enteral-route medication administration
- The clear barrel, dark print, and ENFit® design allows for easy drawing of medication and accurate dose delivery. For use with standard liquids or viscous fluids
- ISO 80369-3 compliant; designed to prevent misconnections
- Connector design provides secure connection to tube set
- Low Dose Tip (LDT) reduces the dead space, ensuring delivery accuracy for small doses (available in 6 mL and smaller)
- Colour: Clear with an orange plunger



Item #	Description	Size	Qty	UPC
99005	<b>A</b> Enteral Syringe with ENFit Connector, Low Dose	0.5 ml	500	063636990053
99101	Enteral Syringe with ENFit Connector, Low Dose	1 ml	500	063636991012
99103	<b>B</b> Enteral Syringe with ENFit Connector, Low Dose	3 ml	500	063636991036
99106	Enteral Syringe with ENFit Connector, Low Dose	6 ml	500	063636991067
99112	<b>C</b> Enteral Syringe with ENFit Connector	12 ml	500	063636991128
99120	Enteral Syringe with ENFit Connector	20 ml	500	063636099121
99160	<b>D</b> Enteral Syringe with ENFit Connector	60 ml	500	063636991609

### ENFit® Bottle Adapter with Connector

- Improve Patient Safety - Prevent accidental misconnections by using items compatible with ISO standard 80369-3.
- Easy to Use - Accessories make it easy to draw medication from bottles or med cups. Adapters are non-sterile.
- Versatile - Adapters with male ENFit connection are available in five sizes to accommodate a variety of bottle neck sizes. Bottle caps can be used with adapters in place.



Item #	Size	Qty	UPC
20312-10	<b>E</b> 12-15 ml	100	063636020316
20313-10	14-16.5 ml	100	063636203139
20314-10	17-20.5 ml	100	063636203146
20315-10	19-23 ml	100	063636203153
20316-10	24-26 ml	100	063636203160

### ENFit® Milk Bottle Transfer Lid

- Enables clean and accurate extraction of milk from a bottle, using an ENFit syringe
- Tethered cap for safe storage
- Can be used in conjunction with Tamper Evident labels for additional security
- A closed system to efficiently draw out the contents of the bottle using an ENFit syringe
- Air circulation feature, to avoid leakage of precious contents



Item #	Qty	UPC
10180	<b>F</b> 50	063636101800

### ENFit® Oral Stepped Bottle Adaptor

- Versatile: Offers a solution for both oral and ENFit syringes
- Size: Stepped adaptor fits bottle opening 16-28 mm

Item #	Qty	UPC
21052	50	063636210526



### ENFit® Transition Connectors

- Use Immediately - Transition connector or "Christmas Tree" adapter bridges the gap until your facility is prepared to switch to the ENFit system as recommended by the new ISO 80369-3 standard. Connects to an ENFit syringe and allows it to connect to old-style feeding tube sets.

Item #	Qty	UPC
19771	100	063636197711

### Rx Crush™ ENFit® Pouches, Threaded

- Avoid Clogged Tubes - Designed for use with the 19846 RxCrush ENFit Tablet Crusher and works with any ENFit syringe. Threaded attachment provides a secure syringe grip. Zip closure keeps crushed medicine contained. Dissolved medication is easily delivered through ENFit feeding tubes.
- Reduce Waste - Residual medication waste is reduced by crushing and dissolving med in the pouch. No med cups or medication straws needed.
- Easy to Use - Place tablet inside ENFit pouch. Attach syringe (sold separately) to pouch before crushing. Place pouch under platform and press down on tablet to crack it before crushing. With pouch under the large roller, rotate roller to achieve desired consistency.

Item #	Size	Qty	UPC
20322	3"W x 5 1/4"H	50	063636203221



### ENFit® Dissolve-A-Dose, 15 ml

- Dissolve cut tablets or powder quicker and easier than the powder paper technique
- ENFit® Adaptable cap allows medication to be drawn up into oral syringe for immediate administration or to add diluents
- 15 ml capacity

Item #	Quantity	UPC
6294	50	063636857684

### Pharmacy Bottle Cap, ENFit® Syringe Compatible

- Facilitate easier and more efficient filling of syringes from a medication bottle

Item #	Size	Qty	UPC
61002	Size B - 20 mm	25	063636610029
61003	Size C - 22 mm	25	063636610036
61004	Size D - 24 mm	25	063636610043
61005	Size E - 28 mm	25	063636610050
61009	Size I - 38 mm	25	063636610098



## What label should I use with my blister?

When choosing a blister & label combination, it is critical that the proper components are aligned with respect to class to provide the stated level of protection.

### Class A

Size	Class A Blister Item Number/Description	Colour	Compatible Laser Labels	Compatible Laser Flag Labels	Compatible Thermal Labels	Compatible Tray
Small	7016 Class A Small Aclar®	Amber	6121	6025	18500	6472
	7074 Class A Small PVdC	Amber	6121	6025	18500	6472
Medium	7014 Class A Medium Aclar®	Amber	6121	6025	18500	6472
	7075 Class A Medium PVdC	Amber	6121	6025	18500	6472
Large	7015 Class A Large Aclar®	Amber	6121	6025	18500	6472
	7076 Class A Large PVdC	Amber	6121	6025	18500	6472
Shallow Round	7021 Class A Round 3/8" Depth PVdC	Amber	6125	N/A	N/A	6461
	7022 Class A Round 3/8" Depth PVdC	Green	6125	N/A	N/A	6461
	7023 Class A Round 3/8" Depth PVdC	Blue	6125	N/A	N/A	6461
Deep Round	7024 Class A Round 1" Depth PVdC	Amber	6125	N/A	N/A	6464
	7025 Class A Round 1" Depth PVdC	Green	6125	N/A	N/A	6464
	7026 Class A Round 1" Depth PVdC	Blue	6125	N/A	N/A	6464
Condensed	7019 Class A Condensed Aclar®	Amber	6123	N/A	N/A	6462
	7079 Class A Condensed PVdC	Amber	6123	N/A	N/A	6462
Micro	7017 Class A Micro Aclar®	Amber	6027	N/A	N/A	6468
Medium	7004 Class A Blister Block Aclar®	Amber	6126	N/A	N/A	6460

### Class B

Size	Class B Blister Item Number/Description	Colour	Compatible Laser Labels	Compatible Laser Flag Labels	Compatible Thermal Labels	Compatible Tray
Small	7013 Class B Small PVC	Amber	6118	N/A	N/A	6470
Medium	7012 Class B Medium PVC	Amber	6118	N/A	N/A	6470
Large	7011 Class B Large PVC	Amber	6118	N/A	N/A	6470
Extra Large	7010 Class B X-Large PVC	Amber	6122	N/A	N/A	6469
Condensed	7007 Class B Condensed PVC	Amber	6123	N/A	N/A	6462
Keyhole	7006 Class B Keyhole PVC	Amber	6118	N/A	N/A	N/A

Unit dose packaging systems are important to healthcare for many reasons, such as their ability to:

- Protect medicine from contamination
- Show damaged packages
- Contain barcodes for individual doses
- Accommodate payment for only the amount of medication needed
- Improve patient services
- Work with electronic documentation

### Unit Dose Solutions

- PharmaSystems® is proud to offer a large selection of unit-dose packaging solutions – blisters and lidding to meet your custom site-specific packaging decision criteria. This system is fast, efficient and economical for small volume packaging – requires less downtime, and no chance of mechanical failure!
- Ideal for small packaging runs, allergy risk medications, high-risk medications, chemo drugs and solid unit dose packaging

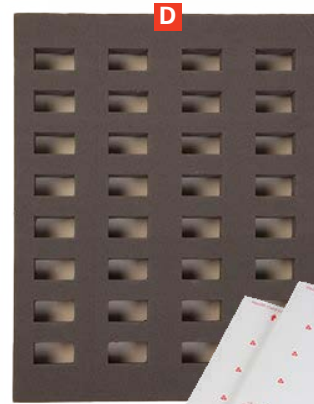

Item #	Description	Dimensions W x H	Setup	UPC
6121*	<b>A</b> Class A Laser Labels for Class A S, M & L Blisters	1 <sup>11</sup> / <sub>16</sub> X 1 <sup>3</sup> / <sub>16</sub> "	4 across and 8 down	063636061210
6025*	<b>B</b> Class A Laser Flag Labels for Class A S, M & L Blisters	3 <sup>3</sup> / <sub>4</sub> X 1 <sup>3</sup> / <sub>16</sub> "	2 across and 8 down	063636060251
18500	<b>C</b> Class A Thermal Transfer Strip Labels for Class A S, M & L Blisters	1 <sup>1</sup> / <sub>8</sub> X 1 <sup>5</sup> / <sub>8</sub> "	1 across	063636185008
6472	<b>D</b> Foam Sealing Tray for Class A S, M & L Blisters	8 <sup>1</sup> / <sub>2</sub> X 11"	4 across and 8 down	063636647209
6126*	<b>E</b> Class A Laser Labels for Blister Blocks	1 <sup>11</sup> / <sub>16</sub> X 1 <sup>3</sup> / <sub>16</sub> "	4 across and 8 down	063636861261
6460	Foam Sealing Tray for Blister Blocks	7 x 10"	-	063636864606

\*Laser labels should be stored at 70° - 80°F and 50% relative humidity (±5%) away from heat sources and not exposed to direct sunlight. Labels should be stored in the room in which they will be printed at least 48 hours prior to printing. Not for use with thermal printers.

### Class A Aclar & PVdC Amber Blisters

- Proper Use:** Blister/label combo meets the USP Class A package requirements
- Packaged:** 16 blisters per strip; 100 strips per package; 16,000 blisters total

### Blister Blocks

- Efficient Design:** This medium-cavity, 16-blisters block allows an entire grid of labels (6126) to be applied simultaneously
- Packaged:** 16 blisters per sheet; 100 sheets per package; 1,600 blisters total

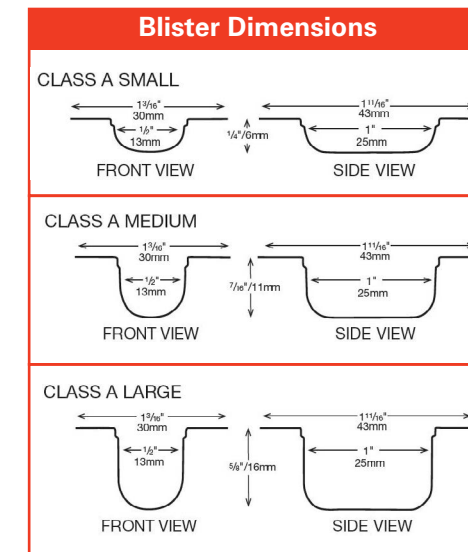

Item #	Description	Setup	UPC
7074	<b>A</b> Class A Amber Blisters, Small, PVdC	2 across and 8 down	063636770747
7016	<b>B</b> Class A Amber Blisters, Small, Aclar	2 across and 8 down	063636770167
7075	<b>C</b> Class A Amber Blisters, Medium, PVdC	2 across and 8 down	063636770754
7014	<b>D</b> Class A Amber Blisters, Medium, Aclar	2 across and 8 down	063636770143
7076	<b>E</b> Class A Amber Blisters, Large, PVdC	2 across and 8 down	063636770761
7015	<b>F</b> Class A Amber Blisters, Large, Aclar	2 across and 8 down	063636770150
7004	<b>G</b> Class A Amber Blister Block, Medium, Aclar	4 across and 4 down	063636870041



### Class A Labels for Blisters

- **Proper Use:** Use with Class A Blisters to meet USP Class A package requirements
- **Neat Application:** Foil labels are paper-topped. No adhesive is applied over the medication cavity or lift open tabs



### Class A Laser Labels for Condensed & Micro Blisters

- Packaged:**  
**6123:** 40 labels per sheet; 100 sheets per box; 4,000 labels total  
**6027:** 35 labels per sheet; 100 sheets per box; 3,500 labels total

Item #	Description	Dimensions W x H	Setup	UPC
6123*	<b>A</b> Class A Laser Labels for Condensed Blisters	1 1/2 X 13/16"	4 across; 10 down	063636761233
6027*	<b>B</b> Class A Laser Labels for Micro Blisters	13/16 X 13/16"	5 across; 7 down	063636060275
6462	Foam Sealing Tray fo Condensed Blisters	8 1/2 x 11"	-	063636064624
6468	<b>C</b> Foam Sealing Tray fo Micro Blisters	8 1/2 x 11"	-	063636064686
7088	4" Roller for Sealing Labels	4"	-	063636770884
7089	8" Roller for Sealing Labels	8"	-	063636770891

\*Laser labels should be stored at 70° - 80°F and 50% relative humidity (±5%) away from heat sources and not exposed to direct sunlight. Labels should be stored in the room in which they will be printed at least 48 hours prior to printing. Not for use with thermal printers.

### Class A Condensed Blisters & Micro Blisters

#### Condensed Blisters

- **Smaller Footprint:** Allows blisters to fit and dispense trouble free from medications cassettes used in automated med dispensers
- **Packaged:** 10 blisters per strip; 60 strips per pacakge; 1,600 blisters total

#### Micro Blisters

- **Small Cavity:** Blister is designed to protect the smallest tablets
- **Packaged:** 7 blisters per strip; 150 strips per pacakge; 1,050 blisters total

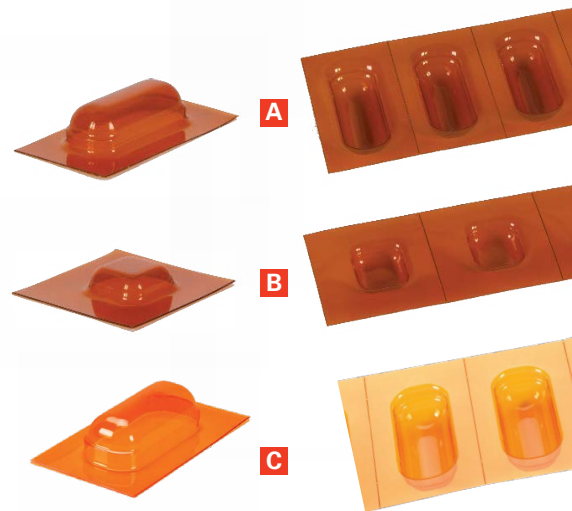
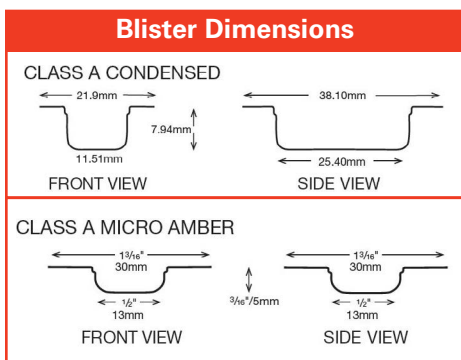

Item #	Description	Setup	UPC
7019	<b>A</b> Class A Amber Blisters, Condensed, Aclar	1 across; 10 down	063636770198
7017	<b>B</b> Class A Amber Blisters, Micro, Aclar	1 across; 7 down	063636770174
7079	<b>C</b> Class A Amber Blisters, Condensed, PVdc	1 across; 10 down	063636770792

### Class A Laser Lables for Round Blisters

- **Neat Application:** Foil labels are paper-topped. No adhesive is applied over the medication cavity or lift open tabs
- **Packaged:** 24 labels per grid; 2 grids per sheet; 100 sheets per box; 4,800 labels total



Item #	Description	Dimensions W x H	Setup	UPC
6125*	<b>A</b> Class A Laser Labels for Round Blisters	13/16 X 13/16"	6 across; 4 down	063636761257

\*Laser labels should be stored at 70° - 80°F and 50% relative humidity (±5%) away from heat sources and not exposed to direct sunlight. Labels should be stored in the room in which they will be printed at least 48 hours prior to printing. Not for use with thermal printers.

### Foam Sealing Trays & Rollers for Round Blisters

- **Expedite Filling & Sealing:** Holds Class A round Blisters in place

Item #	Description	UPC (063636)
6464	<b>A</b> Foam Sealing Tray for Deep Round Blisters	064648
6461	Foam Sealing Tray for Shallow Round Blisters	764616
7088	4"W Roller for Sealing Labels	770884
7089	<b>B</b> 8"W Roller for Sealing Labels	770891

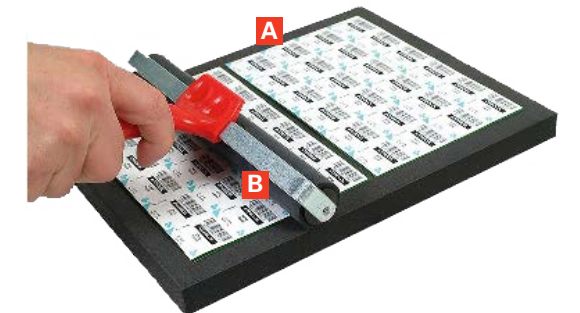

### Class A Round Blisters

- **Construction:** PVdc
- **Colour Options:** Blisters are available in Amber, Green & Blue
- **Special Features:** Amber & Green blisters meet USP requirements for protection of UV light-sensitive medication. Blue Blisters do not provide UV light protection
- **Packaged:** 24 Blisters per sheet' 100 sheets per package' 2,400 blisters total

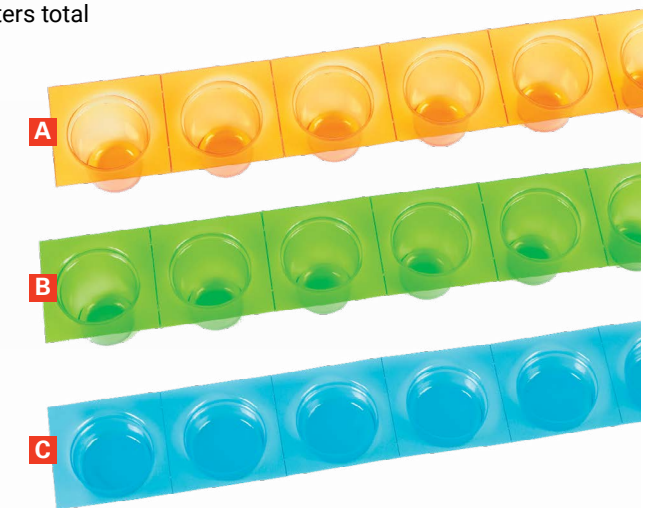
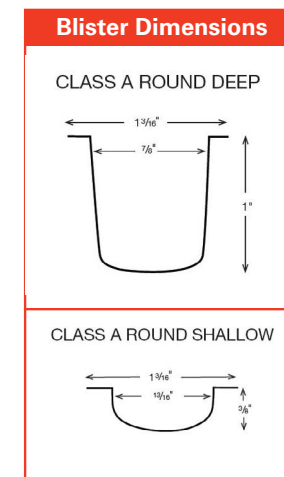

Item #	Description	Setup	Colour	UPC
7024	<b>A</b> Class A Round Deep Blisters	6 across; 4 down	Amber	063636070243
7025	<b>B</b> Class A Round Deep Blisters	6 across; 4 down	Green	063636070250
7026	Class A Round Deep Blisters	6 across; 4 down	Blue	063636070267
7021	Class A Round Shallow Blisters	6 across; 4 down	Amber	063636770211
7022	Class A Round Shallow Blisters	6 across; 4 down	Green	063636770228
7023	<b>C</b> Class A Round Shallow Blisters	6 across; 4 down	Blue	063636770235

### Class B Labels for Blisters

- **Proper Use:** Use with Class B Blisters to meet USP Class B package requirements.
- **Neat Application:** Foil labels are paper topped. No adhesive is applied over the medication cavity or lift open tabs.
- **Color Options:** 6118 Laser Labels are available in White and Yellow.

**Packaged:**

**6123 and 6118:** 40 labels per sheet; 100 sheets per box; 4,000 labels total

**6122:** 28 labels per sheet; 100 sheets per box; 2,800 labels total

**17295:** 1,600 labels per roll total



Item #	Description	Dimensions W x H	Setup	Qty	UPC
6123	<b>A</b> Class B Laser Labels for Condensed Blisters	1 1/2 x 13/16	4 across; 10 down	4,000	063636761233
6118	<b>B</b> Class B Laser Labels for Keyhole S, M, L Blisters	1 3/4 x 1	4 across; 10 down	4,000	063636761189
6122	<b>C</b> Class B Laser Labels for X-Large Blisters	1 3/4 x 1 1/2	4 across; 7 down	2,800	063636761226
6462	Foam Sealing Tray for Condensed Blisters	8 1/2 x 11		1	063636064624
6470	Foam Sealing Tray for S, M, L Blisters	8 1/2 x 11		1	063636064709
6469	<b>D</b> Foam Sealing Tray for X-Large Blisters	8 1/2 x 11		1	063636064693
7088	<b>E</b> 4"W Roller for Sealing Labels	-		1	063636770884
7089	8"W Roller for Sealing Labels	-		1	063636770891

### Class B Amber PVC Blisters

- **Proper Use -** The combination of Class B Blisters and Labels meets USP Class B package requirements.

**Packaged:**

7006, 7013, 7012, 7011: 20 blisters per strip; 125 strips per package; 2,500 blisters total

7007: 10 blisters per strip; 250 strips per package; 2,500 blisters total

7010: 14 blisters per strip; 180 strips per package; 2,500 blisters total

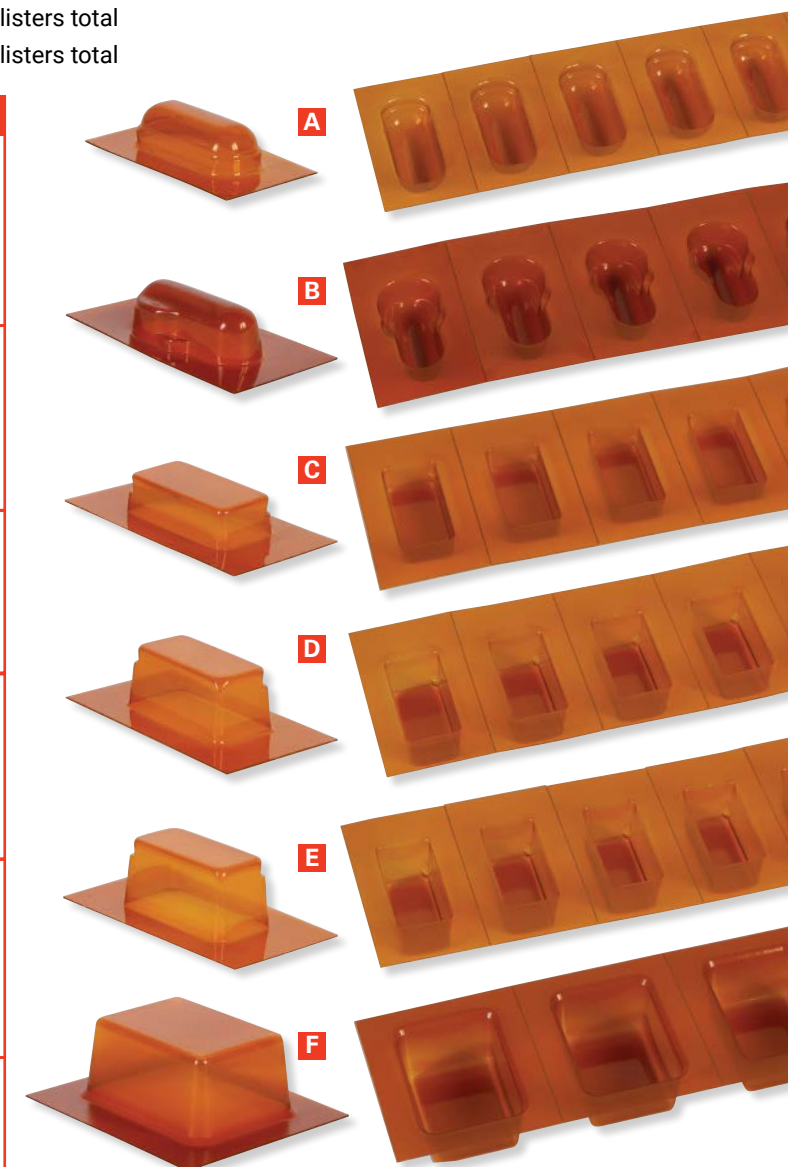
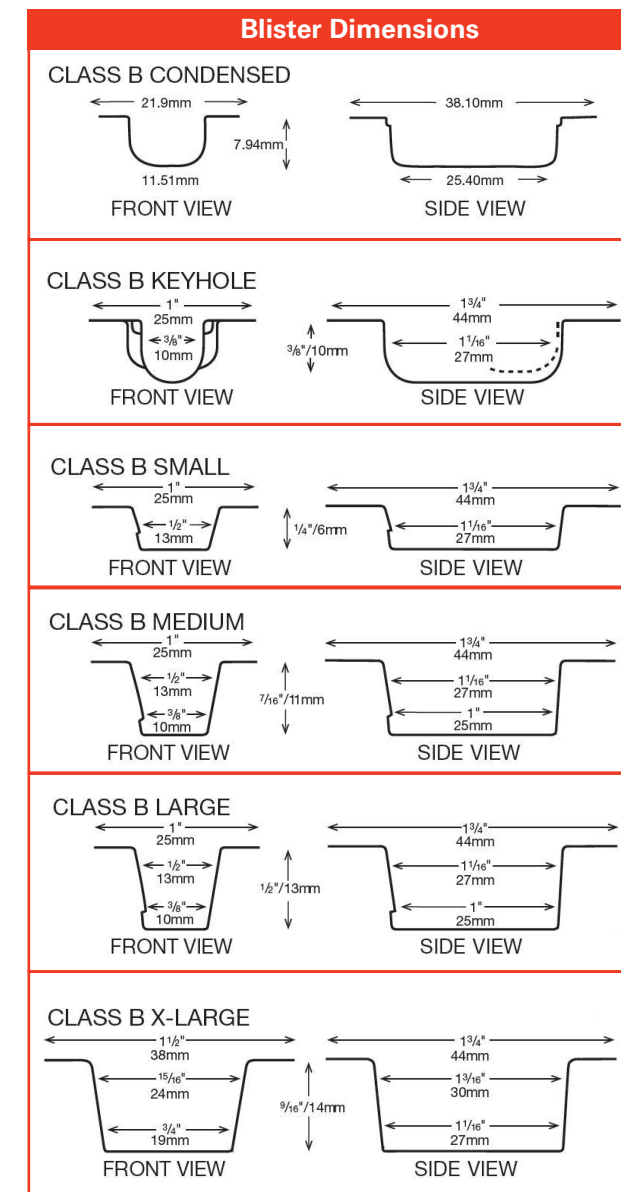

Item #	Description	Setup	Qty	UPC (063636)
7007	<b>A</b> Class B Amber Blisters, Condensed, PVC	1 across; 10 down	2,500	063636770075
7006	<b>B</b> Class B Amber Blisters, Keyhole, PVC	2 across; 10 down	2,500	063636770068
7013	<b>C</b> Class B Amber Blisters, Small, PVC	2 across; 10 down	2,500	063636770136
7012	<b>D</b> Class B Amber Blisters, Medium, PVC	2 across; 10 down	2,500	063636770129
7011	<b>E</b> Class B Amber Blisters, Large, PVC	2 across; 10 down	2,500	063636770112
7010	<b>F</b> Class B Amber Blisters, X-Large, PVC	2 across; 7 down	2,500	063636770105

### Ointment Blisters, Labels & Sealing Trays

- **Convenient:** Package and dispense small volumes of ointments in easy-to-use unit dose blisters. Small Ointment Blisters hold approximately 1.2mL; Large Ointment Blisters hold approximately 1.8mL.
- **Easy-to-Fill:** Ointment Blister Filler/Sealing Tray is a two-piece system that uses an acrylic base to hold ointment blisters and an overlay to prevent ointment from spilling onto blister edges. Color overlay provides an easy visual cue for mess-free filling.

**Ointment Blisters:** 12 per sheet; 100 sheets per package; 1,200 blisters total; 4 across, 3 down

**Laser Labels for Small Ointment Blisters:** 12 labels per grid; 2 grids per sheet; 100 sheets per box; 2,400 labels total

**Laser Labels for Large Ointment Blisters:** 12 labels per sheet; 100 sheets per box; 1,200 labels total

**Foam Sealing Tray:** Holds blisters in place during filling and label application.

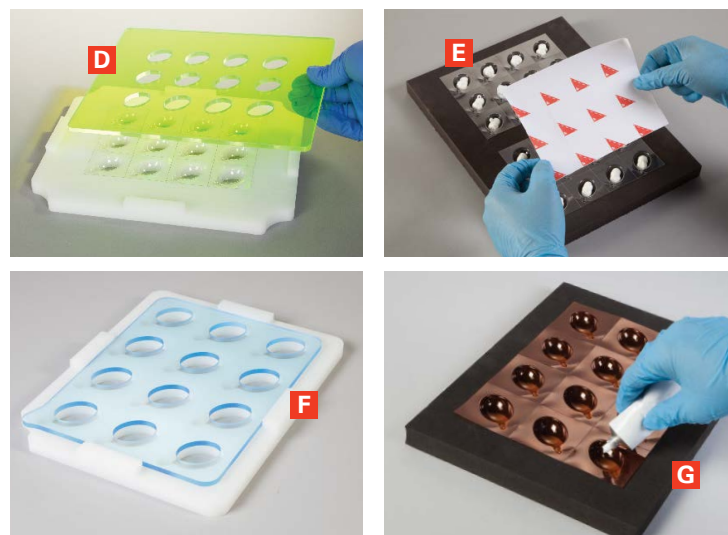
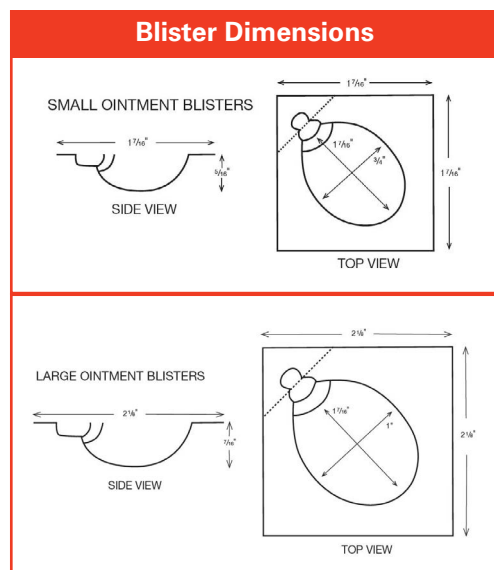
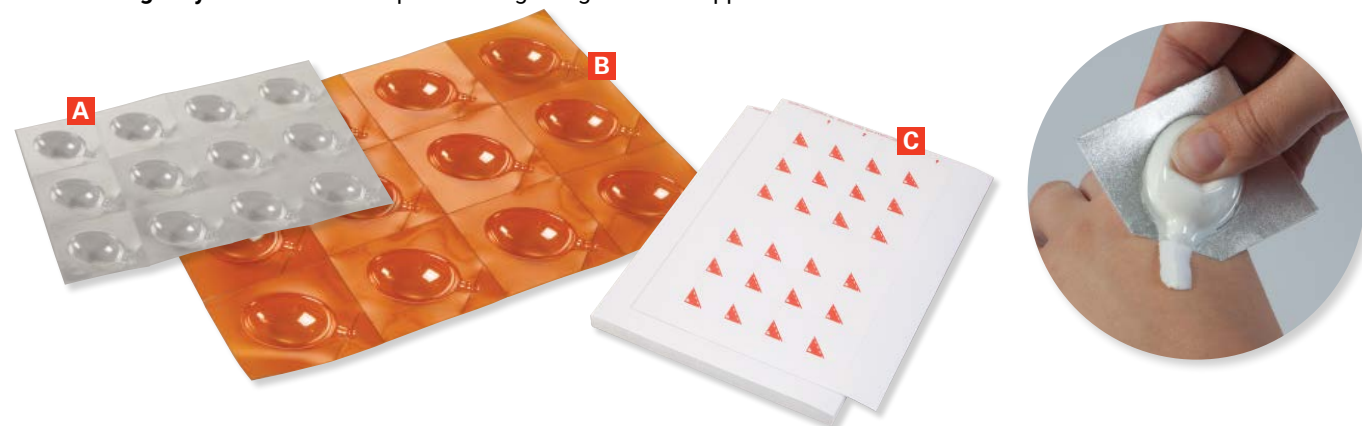

Item #	Description	Qty	UPC (063636)
19339	<b>A</b> Ointment Blisters, Small, Clear	1,200	063636193393
19610	Ointment Blisters, Small, Amber	1,200	063636196103
19611	Ointment Blisters, Large, Clear	1,200	063636196110
19612	<b>B</b> Ointment Blisters, Large, Amber	1,200	063636196127
19470	<b>C</b> Laser Labels for Small Ointment Blisters	2,400	063636164706
19559	<b>D</b> Ointment Blister Filler/Sealing Tray, Small	1	063636195595
19556	<b>E</b> Foam Sealing Tray for Small Ointment Blisters	1	063636195564
19613	Laser Labels for Large Ointment Blisters	1,200	063636196134
19615	<b>F</b> Ointment Blisters Filler/Sealing Tray, Large	1	063636196158
19614	<b>G</b> Foam Sealing Tray for Large Ointment Blisters	1	063636196141

### Anti-Fatigue Mats

- Cushioned anti-fatigue mats reduces the risk of fatigue or static posture often caused by standing for long periods of time
- PharmaSystems® is proud to offer the following selection of anti-fatigue matting for use in dry environments
- Anti-fatigue mats are made to order. Additional lengths available with no shipping delays - contact our customer service team for options and pricing

#### How to select your anti-fatigue mats:

- Select by compound and thickness
- **Tabor Abrasion** – how well the surface withstands wear; the less weight lost the more durable the product (based on Federal Standard 191/1000g, CS-17 wheel; percentage lost refers to amount lost at 1000 cycles)
- **Coefficient of Friction** – degree of traction provided (OSHA recommends .5 in dry areas), based on ASTM F1677
- **Compression Deflection** - the softness or comfort leve (ideal range is considered .20-.50); measured by percentage or inches @ 35 psi (Ψ)



### Ribbed Anti-Fatigue Mats

- Economic comfort for light industrial applications
- Safety round edges
- Made-to-order lengths available, contact our customer service team
- Thickness: 3/8" (9 mm)
- Material: PVC Sponge
- Temperature Range: -17 - 43° C (0-110° F)
- Tabor Abrasion: 2% Lost
- Coefficient of Friction: Dry = .94 / Wet = .72
- Compression Deflection: ASTM D575/ .205 @ 35 Ψ

Item #	Size	Depth	Colour	Weight	UPC
5270	2 x 3'	3/8"	● Grey	4.45 lbs.	063636752705
5272	3 x 5'	3/8"	● Grey	10.1 lbs.	063636752729
5274	3 x 12'	3/8"	● Grey	26.14 lbs.	063636752743

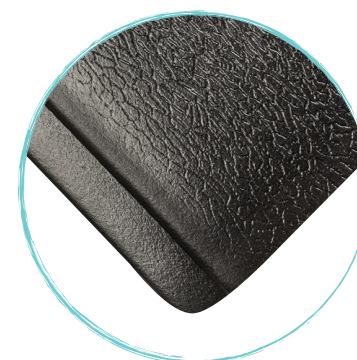
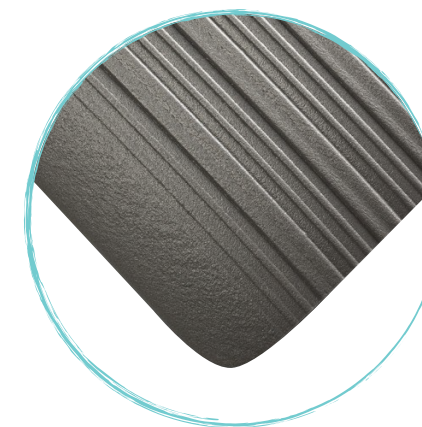

#### Custom Mat Options!

Anti-fatigue mats to your specifications & imprinting options available! Contact our customer service team to place your custom order today!

### Endurable Mats

- Economic comfort for medium traffic areas
- Dual-layer construction outlasts lower quality blown sponges
- Safety beveled edges
- Made-to-order lengths available, contact our customer service team
- Thickness: 1/2" (13 mm)
- Material: Dual Density PVC Sponge
- Tabor Abrasion: 2% Lost
- Coefficient of Friction: Dry = .91
- Compression Deflection: ASTM D575/ .23 inches @ 35 Ψ

Item #	Size	Depth	Colour	Weight	UPC
45935	3 x 5'	1/2"	● Black	14.1 lbs.	063636745394
459312	3 x 12'	1/2"	● Black	40.1 lbs.	063636745936
45934	3 x 4'	1/2"	● Black	-	063636745967
459310	3 x 10'	1/2"	● Black	-	063636745905

### Autoclavable Anti-Fatigue Mats

- Autoclavable - Mat provides comfort in any environment where the equipment and flooring must be sterilized.
- Material - Solid, non-porous rubber with textured surface
- Cleaning - Autoclavable up to 175°F (135°C)
- Quantity - Sold individually

Item #	Size	Depth	Colour	Weight	UPC
17712	2 x 3'	1/2"	● Grey	11 1/2 lbs.	063636177126



### Anti-Microbial Tile Top Mats

- Ideal for labs, pharmacies, and pharmaceutical manufacturing
- Combats fatigue with top to bottom anti-microbial protection
- Absorbs repeated compression and bounces back better than PVC sponge matting
- Safety beveled edges
- Made-to-order sizes and shapes available, contact our customer service team
- Thickness: 1/2" (13 mm)
- Material: PVC Surface with Anti-Microbial Nitrile Infused Sponge
- Temperature Range: -17 - 43° C (0-110° F)
- Tabor Abrasion: Federal Standard 191
- Coefficient of Friction: Dry = .78

Item #	Size	Depth	Colour	Weight	UPC
5290	2 x 3'	1/2"	● Grey	7.1 lbs.	063636752903
5288	3 x 5'	1/2"	● Grey	18.1 lbs.	063636752880



### Deluxe Anti-Microbial Tile Top Mats

- Combats fatigue with top to bottom anti-microbial protection
- Absorbs repeated compression and bounces back better than PVC sponges
- Safety beveled edges
- Made-to-order sizes and shapes available, contact our customer service team
- Thickness: 7/8" (22 mm)
- Material: PVC Surface with Anti-Microbial Nitrile Infused Sponge
- Temperature Range: -17 - 43° C (0-110° F)
- Tabor Abrasion: Federal Standard 191
- Coefficient of Friction: Dry = .78
- Compression Deflection: ASTM D395-98/ 20%

Item #	Size	Depth	Colour	Weight	UPC
5754	2 x 3'	7/8"	● Black	8.1 lbs.	063636575403
5756	2 x 3'	7/8"	● Grey	8.1 lbs.	063636757564
5758	3 x 5'	7/8"	● Black	19.1 lbs.	063636757588
5760	3 x 5'	7/8"	● Grey	19.1 lbs.	063636757694



### Tacky Mats

- Economic and effective solution for dirt control - adhesive surface covers full area of the mat to pull dirt and dust off shoes
- Ideal for rooms requiring protection against dust and bacteria pollution, helps maintain sanitary conditions of cleanrooms
- Suitable for use in pharmacies, laboratories, and operating rooms
- Made of polyethylene, USP compliant
- Disposable – simply remove the top layer once contaminated

### Peel Away Dirt & Dust Control Mats

- Construction - Designed with multiple sheets. When top sheet is contaminated, pull it off and discard.
- Prevent Contamination - Tacky surface pulls dirt and dust off shoes before they can contaminate a cleanroom.
- Quantity: 30 sheets per mat; 4 mats per package; 120 sheets total

Item #	Size	UPC
17736	36 x 18"	063636177362
7384	45 x 18"	063636773847
17738	36 x 24"	063636177386
17737	45 x 24"	063636177379
17739	45 x 36"	063636177393



### Tacky Mats

- Construction: 2-mil thick sheets have adhesive coating with antimicrobial germicide that covers the full area of the mat
- Ready to use: mats remove dirt, dust and lint on contact from shoes
- Quantity: 30 sheets per mat; 4 mats per package; 120 sheets total
- Tab system helps remove top layer

Item #	Size	UPC
5601-01	34 x 18"	063636756017
5602-01	45 1/2 x 18"	063636756024
5603-01	24 x 34"	063636756031
5605-01	46 x 36"	063636756055
5606-01	60 x 36"	063636756062



### Hog Heaven Marble Mat

- Hog Heaven Marble mats feature the same excellent anti-fatigue qualities of a standard Hog Heaven mat, but with a smooth surface that allows workers to pivot freely
- Comfortable - High-density, closed-cell nitrile-blended cushion helps eliminate pressure to the lower back and legs, providing superior comfort; smooth top allows workers to pivot freely
- Safe - Certified high-traction by the National Floor Safety Institute (NFSI); sloped edges provide a safe transition from floor to mat
- Durable - Surface is molded, not glued, to the nitrile-blended cushion so it will not separate
- Easy to Clean - Smooth diamond-patterned vinyl surface is easy to clean
- Colour - Black, Grey and Blue

Item #	Size	UPC
MA4482X3K	24 x 36"	063636048235

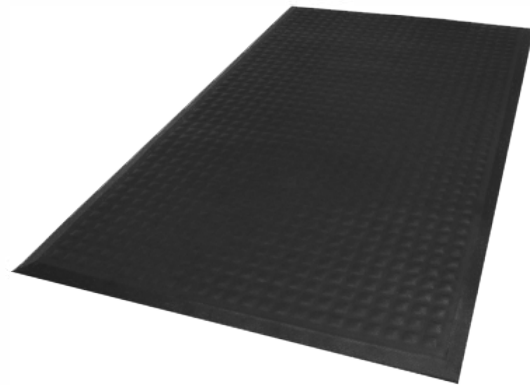

### Complete Comfort Mat

- Complete Comfort II mats are anti-microbial anti-fatigue mats that can be autoclave sterilized and commercially laundered

Item #	Size	UPC
MA5942X3K	24 x 36"	063636094232
MA5943X5K	36 x 60"	063636094355



### Heavy-Duty Stepstools

- Use to reduce risk of static posture; shift weight off one foot by resting it on stepstool
- 350 lb. capacity
- Wheels for easy relocation
- Dimensions: 16 x 13 inches (40.6 x 33 cm)

Item #	Colour	UPC
5202E	Beige	063636031645
5202K	Black	063636009323

### Kango® Polyurethane Chairs

- Ergonomically designed seats and backrests provide lumbar support to reduce worker fatigue
- Seat and backrest covered with ½" thick polyurethane to inhibit punctures, tears and moisture absorption
- Center columns are pneumatic for almost effortless seat adjustment - simply pull up or push down on the lever to adjust
- Seats swivel 360°



### Kango® High Polyurethane Chair

- Fully customize footrest and tilting back rest
- Sturdy aluminum foot rest, with chrome-plated base

### Kango® Low Polyurethane Chair with Casters

- Lower chair height adjustment ideal for use at shorter workstations and tables
- Stable, 5-leg, chrome-plated base with casters



### The Kango® Stand-Up Seat

- Ergonomic design reduces risk of fatigue from static posture
- Provides comfort and relief when performing jobs that require long periods of standing
- Ideal for pharmacy and hospital use
- Work standing up with legs stretched out and 2/3 of body weight resting on the seat, leaving only 1/3 of body weight to be absorbed by feet
- Keeps the back straight and ergonomically positioned, preventing shoulders from rounding
- Compact and easily transportable – includes carrying handle that allows the seat to be carried to another workstation or department



Item #	Description	Seat Height	Seat Width	Base	UPC
8421	<b>A</b> Kango® High Polyurethane Chair with Tilt & Footrest	22 - 31½"	15½"	22½"	063636784218
8424	<b>B</b> Kango® Low Polyurethane Chair without Tilt with Casters	17¾ - 22¾"	15½"	22½"	063636784249
8420	<b>C</b> Kango® Stand-Up Seat	28 - 37"	15½"	19"	063636784201

## Prescription Bags

- Convenient - Printed white paper bags in three sizes provide a convenient, cost-effective method of med packaging at the pharmacy and upon patient discharge. Largest size bag has a flat bottom for convenient filling.
- No Additional Fees - No order minimums and no set-up fees.
- Package - 100 per package

Item #	Dimensions (W x H x D)	UPC
19927	A 3 1/2 x 9 3/4 x 1 1/2"	063636199272
19928	B 5 x 10 x 2"	063636199289
19929	5 1/4 x 10 15/16 x 3 7/8"	-



## Fretwell's Triangle

- Count regular shaped tablets with absolute accuracy and speed
- Tablets glide easily on the stainless steel triangle
- Easy to clean

Item #	UPC
FT1	C 063636886202

## Tablet Counters

- Plastic pill counting tray with clear lip handle and two corner spouts
- Effective way to keep organized with pill counting
- Includes plastic spatula (0.6 x 5 1/2") to aid counting and transferring pills
- Recommended for right-handed users
- Measures: 8 1/4 x 6 x 1"

Item #	Colour	UPC
D-50	D Clear/Blue	063636050306

## Ergonomic Tablet Counters

- Includes spatula with ergonomic grip for easy handling and docking slot
- Designed to provide stability while counting tablets
- Deep blue colour allows pills and powder traces to contrast with tray
- Measures: 7 3/4 x 6.15 x 0.4"

Item #	Description	UPC
7147	Right-Handed	063636771478
7148	E Left-Handed	063636771485

## Ambidextrous Tablet Counter

- Polyethylene pill counting tray for left or right handed users
- Spatula included
- Chute has a hinged cover for easy filling
- Measures: 7 3/4 x 6 1/4 x 1 1/2"

Item #	Description	UPC
12261	F Left or Right Handed	063636122614

## Stainless Steel Trays

- Heavy-gauge stainless steel tray can be used as a processing tray, medical supply organizing tray or a pass-through tray to the cleanroom
- Ideal for the pharmacy and lab use
- Seamless, non-corrosive metal tray has open corners and easy-grip handles and nests when empty
- View all stainless steel trays on page 32

Item #	Size	Dimensions (W x H x D)	UPC
18779	Small	11 11/16 x 2 1/16 x 6 3/8"	063636187798
18665	Large	15 x 2 1/4 x 10 3/16"	063636186654
18783	Shallow	12 x 1/2 x 9"	063636187835



## Rx Fill Tray

- Rx fill trays help keep individual prescription components together from arrival at the drug store to the prescription pick up counter
- Trays have easy-grip handles, nest when empty to save space
- Available in ● blue, ○ clear, ● green, ● red, ○ white and ● yellow - specify colour when ordering

Item #	Outside Dimensions (W x L x H)	UPC
17487	6 7/8 x 10 1/2 x 2 1/2"	063636717230

## Disposable Ampule Breaker

- Ampules can be safely opened by snapping the top of the ampule breaker to the side; thus breaking the top of the ampule off at the neck of the bottle - top of the ampule can then be discarded along with the ampule breaker
- Reduces the chance of finger cuts and cross contamination
- Disposable - eliminates need for sterilization
- Made out of polypropylene plastic
- Measures 2 x 1 1/4"

Item #	Quantity	UPC
10262	100	063636102623



### Hanging Prescription Bags

- Simplify prescription organization and retrieval
- Made of tough, clear 4 mil plastic for extreme durability
- Fits on any rod with a diameter of 1 cm or smaller

Item #	Size (W x H)	Qty	UPC
17540 <b>A</b>	10 1/2 x 7 1/2"	10	063636175405
17541	12 x 9"	10	063636175412
17542	14 x 12 1/2"	10	063636175429



### Wall Rack for Prescription Bags

- Simple solution to prescription organization
- Saves time, improves accuracy and enhances customer satisfaction
- Aluminum frame is 3 ft. wide and holds five 1 cm thick rods
- Each rod holds approximately 8-10 bags per foot or as many as 150 bags per rack
- Easy assembly, all hardware included
- Measures: 36" W x 57 1/2" H x 7 1/2" D
- Use with hanging bags and ID tags (sold separately)

Item #	Description	Qty	UPC
17543	Wall Rack for Prescription Bags	1 frame, 5 rods	063636175436
17544 <b>B</b>	Green ID Tags	25	063636175443



### Multi-Cut Utility Shears

- Stainless steel blade, ideal for cutting bandages, dressing, fabric, or other tough material
- Colours available: ● black, ● blue, ● orange, ● pink, ● purple, ● red and ● yellow -specify when ordering

Item #	UPC
95-105 <b>C</b>	063636941956



### Handle Universal Scissors

- Stainless steel blade

Item #	Size	UPC
S3115 <b>D</b>	5 1/2"	063636831158



### Forceps

- Made of stainless steel

Item #	Description	Size	UPC
F4111	Dressing Forceps	4 1/2"	063636841119
3039	Dressing Forceps	5 1/2"	063636730390
F0111 <b>E</b>	Super Fine Straight Splinter Forceps	4 1/2"	063636701116

### Stock Prescription Receipt Pads

- Three popular sizes and designs
- Padded in 100's, sold in 1000's

Item #	Description	Qty	UPC
PRP-3 <b>A</b>	4 1/4 x 7"	10 pads of 100 sheets	063636300005
PRP-6 <b>B</b>	3 1/4 x 7"	10 pads of 100 sheets	063636660000
PP-8 <b>C</b>	4 1/4 x 6" (Hole Punched)	10 pads of 100 sheets	063636800000



### Rx Tape

- 3 sizes are individually packaged for convenient storage
- Two core sizes to fit different tape dispensers

Item #	Width	Length	Core Size	UPC
T1-1	1"	33 yards	1"	063636024338
T1-3	1"	72 yards	3"	063636024666
T1-5	1 1/2"	72 yards	3"	063636036669
T1-7	2"	55 yards	3"	063636048501

### Tape Dispensers

#### Single Roll Tape Dispenser

- Accepts tape up to 1" wide
- Core adapter accommodates 1" and 3" cores

#### Double Roll Tape Dispenser

- Accepts tape up to 2" wide
- Core adapter accommodates 3" cores

#### Triple Roll Tape Dispenser

- Accepts tape up to 3" wide
- Can run 3 rolls of 1" wide tape or two rolls of 1 1/2" tape individually, 3" core

Item #	Description	UPC
TD1 <b>D</b>	Single Roll Tape Dispenser	063636010003
GF2306 <b>E</b>	Double Roll Tape Dispenser	063636230661
GF2336 <b>F</b>	Triple Roll Tape Dispenser	063636233662



### Prescription Boxes

- Storage - Use for storing archives or keep it on the counter for organizing incoming prescriptions
- Shipping - The paperboard box is shipped flat and is easy to assemble.

Item #	Size	L x W x H	Qty	UPC
11194	A	Small	13 x 6 1/4 x 4 1/2"	1 063636711948
10196	B	Large	16 1/8 x 5 3/4 x 7 1/2"	1 063636701963



### Prescription File Folders

- Keeps prescription slips organized for quick reference and storage
- Double fold file folders hold approximately 100 prescription sheets
- When folded, the spine is 1/2" deep and can be used to label or identify contents
- Measures: 5 1/2 x 13"
- Accommodates: 5 1/2 x 4" prescription slips

Item #	Qty	UPC
1976	C 100	063636819767
19464	D 100	063636194642

### Tongue Depressors

- Sterile
- Individually wrapped tongue depressors
- Sterilized and wrapped in peel open envelope
- 100 per pack

Item #	Qty	UPC
T1100	100	063636110000



### Automated Pill Crusher

- Crush multiple pills at once!
- Simple to use: Just put your pills in the cups, place the cups in the machine and push one button to start the crush cycle. And you can use the cups to mix in apple sauce or other food stuff as desired.
- Improved medication dosing: Crush, mix & serve from same cup
- Finer powder: Easier swallowing, avoid swallowing chunks
- Includes 10 cups

Item #	Description	UPC (063636)
7300	Automated Pill Crusher, Generation 2	063636173005
7310B	Cups for Pill Crusher (7300) (1000 per pack, 500 Top design and 500 Bottom design)	063636273101



### Powder Crush Automated Medication Crusher

- Saves time, eliminates the problem of cross contamination & crushes medications to a super-fine powder
- Battery operated: Powered by 2 long-lasting rechargeable batteries (charger included)
- Easy to Use: Reduces the chance of repetitive strain injuries for nurses and other users
- Dimensions: 3 1/4" W x 11" L x 3 3/4" H

Item #	Description	Quantity	UPC
PC300	Automated Medication Crusher	1	063636030001
39-1000	Powder Crushing Bags	1000	063636391003
39-8000	Powder Crushing Bags	8000	063636398002

### Silent Knight® Tablet Crusher & Pouches

- Clear plastic pouches safely contains pills during crushing process, eliminating cross contamination and unnecessary clean up
- Latex-free
- 7 mil thick polyethylene

Item #	Description	Qty	UPC
7414-31	Pouches, 2" x 4 3/4"	1000	063636714314
7414-10	Pouches, 2" x 4 3/4"	100	063636714109
7424-01	Silent Knight® 10 1/2 x 3 x 4 1/2"	1	063636074241



### Silent Knight®

- Quiet and powerful pill crusher - silently crushes tablets without disturbing patients
- Ideal for use during night or early morning shifts
- Features OxiTitan™ antimicrobial coating to help fight infections
- Can be cleaned with any disinfecting cleaner
- Crushes pills and tablets into fine powder- reduces risk of clogging feeding tubes
- Requires minimum force to crush tablets, reducing risk of wrist or arm injuries
- Storage compartment provides easy access to pouches

### Stainless Steel Tablet Crusher

- Durable: Stainless steel crusher is designed for repetitive crushing. Crusher includes 48 cups.
- Two-Cup Crushing - Use one ½ oz. Paper Souffle Cup (7368) to hold tablets and another to cover. (Do not crush enteric coated tablets).
- Includes 48 crush cups

Item #	Dimensions L x W x H	UPC
7349-01	9 x 2 1/2 x 2 3/4"	063636773496



### White Powder Coated Tablet Crusher

- One Tough Crusher - Constructed using heavy-duty, white powder coated, die cast components and stainless steel fittings.
- Mountable - Metal Mounting Bracket (7356, sold separately) affixes the crusher to a counter or cart top.
- Two-Cup Crushing - Use one ½ oz. Paper Souffle Cup (7368) to hold tablets and another to cover. (Do not crush enteric coated tablets).

Item #	Description	UPC
7355	Metal Tablet Crusher 8 1/2" L x 3 1/2" W x 3" H	063636773557
7356	Metal Mounting Bracket	063636073565



### Stainless Steel Tablet Pulverizer

- Powerful Crushing - Tablets are reduced to a fine powder that passes easily through various types of feeding tubes without clogging. Do not crush enteric coated tablets.
- Stays Put - 3" square base unit has a rubberized non-slip pad and features two drilled holes so the pulverizer can be permanently mounted.
- Note - This item is not a registered medical device.
- Cup Dimensions - 1 3/4"H x 1 1/2" D

Item #	Description	UPC
7340	Tablet Pulverizer with Handle Separate	063636773403
7344	Tablet Pulverizer with Handle Attached	063636773441



### Quiet Crusher

- Quiet: Crusher uses a rolling action which is quiet and crushes medication to a fine powder without all the noise (do not crush enteric coated tablets)
- Smart Construction: Reinforced metal-filled polycarbonate construction is designed to make the crusher lightweight, strong and durable
- Built-in Bag Storage: Dispensing box can be stored in the built-in holder on the back of the crusher to keep bags readily available
- Less Waste: 7 mil bags have curved bottoms to prevent powder from sticking in corners
- Dimensions: 12"W x 3 5/8"H x 3 3/4"D
- Includes 100 bags (Item #7414-10)

Item #	Description	UPC
12655	Quiet Crusher	063636126551



### The Ultimate Pill Crusher

- Easy Crushing: Ergonomic design lets users crush tablets with a gentle push of the handle. Spring design absorbs shock and vibration for quiet crushing
- No-Slip Design - Skid tape holds the unit steady.
- Two-Cup Crushing: Use one ½ oz. Paper Souffle Cup (7368) to hold tablets and another to cover. (Do not crush enteric coated tablets)
- Durable: Lightweight crusher is made of anodized, non-corrosive aluminum

Item #	Dimensions (W x H x D)	UPC
17120	A 9 13/16 x 5 1/2 x 3 15/16"	063636773557



### Easy Empty Crusher Bag

- Reduce Risk: Durable polyethylene bags hold multiple tablets in place during crushing and help prevent cross contamination.
- Easy to Use: Conveniently packaged in a dispensing box.
- Quick Delivery: Tear and remove the 8-mil bag's perforated strip to easily empty from the bottom! Shorter traveling distance for medication allows for quicker and complete delivery.
- Less Waste: Funnel shaped bag guides crushed medication out of the bag to prevent powder from sticking in corners.
- Convenient Access: Dispensing box can be stored in the holder on the back of the Quiet Crusher.
- Thickness: 8-mil

Item #	Dimensions (W x H)	Qty	UPC
12679	B 1 13/16" x 4 11/16"	100	063636126797



### Pill Crusher

- For easy and effective tablet crushing
- Includes 2 storage compartments
- Latex & BPA free

Item #	Dimensions (W x L x H)	UPC
PS7346	C 2 x 2 x 3"	063636423827



### Pill & Tablet Splitters

- Built-in storage compartment
- Can be custom imprinted
- Latex & BPA free

Item #	Description	UPC
PS7345	D Pill & Tablet Splitter	063636073459
PS7325	E Deluxe Pill & Tablet Splitter with non-slip grip surface	063636073251
PS7305	F Safety Pill & Tablet Splitter with Blade Guard	063636073053



**Paper Cups**

- Paper: This cup is cost efficient & disposable
- Tightly wound rims and recessed base helps prevent tipping or spilling on counter tops
- Quantity: 250 cups per sleeve; 4 sleeves/package, 1,000 cups total Box pleat design for durability

Item #	Capacity	Qty	UPC
7368	1/2 oz.	1000	063636873684
7369	<b>A</b> 1 oz.	1000	063636873691



**Graduated Medication Cups**

- ISMP recommended: mL only Medication Cups eliminate confusion between mL and teaspoon markings and reduce the risk for dosing errors. Clear cups with FDA -compliant food-grade ink improve visibility, accuracy and patient safety initiatives as well as medication compliance
- Easy to Use: Cup features a wide mouth that allows for easier drinking and filling of liquid medication, and can accommodate multiple and large tablets/capsules
- Efficient: Lids protect medication from contamination and spilling

Item #	Description	Size	Qty	UPC
5149-01C	<b>B</b> Wide Graduated Cups	30 mL	2,000	063636514914
5148-01	Lids for Wide Cups	-	2,000	063636514815
5165	<b>C</b> Narrow Graduated Cups	30 mL	400	063636751654
5160	Lids for Narrow Cups		400	063636751609



**Plastic Cups**

- Item # 7360 is recommended for methadone dispensing

Item #	Description	Size	Qty	UPC
7364	<b>D</b> Graduated	1 oz.	1000	063636873646
7362	Graduated	2 oz.	1000	063636127626
7360	Not Graduated	3 1/2 oz.	100	063636126612
7361	Not Graduated	5 oz.	100	063636127619

**Wax Paper Cups**

- Disposable cups
- Wax-treated paper to help increase durability and prevent leaks

Item #	Size oz.	Qty	UPC
7363	<b>E</b> 3 oz.	2400	063636873653
7366	<b>F</b> 5 oz	1200	063636773663



**Medication Cup Transport Tray**

- Transport tray keeps multiple medication cups and syringes organized on one tray for easy transport during medication passes
- Made of white impact resistant plastic
- Impact-Resistant: Plastic tray holds 20 cups
- Measures: 13 1/4"W x 1 1/2"H x 14 5/8"D

Item #	UPC
5145	063636751456

**Medication Crushing/Cutting Cups**

- Two in One - Combines the convenience of cutting and crushing tablets in one tool
- Easy Cutting - Cut by placing a tablet in the triangular-shaped area of the cutter and pushing down on the top cup to split the tablet
- Easy Crushing - Cups are designed for use in pairs with a grinding area located between the cup surfaces. Top cup snaps onto bottom for mixing
- Durable - Cups are constructed of thick, heavy-duty, plastic designed to withstand heavy grinding pressure
- Note - This item is single-use
- Dimensions: 2"W across top and 1"W across the bottom x 1 3/4"H

Item #	Qty	UPC
7337-01	1 Set	063636733704
7337-10	20 Sets	063636773717



### Metro® Utility Cart

- 3 shelves – middle shelf can adjust in 1" increments
- Ergonomic handle designed for easy use
- Smooth surfaces are designed to resist staining and can be easily wiped clean
- All-polymer shelf will resist corrosion
- Features a 13 mm raised ship's edge design to contain products or spills

Item #	Dimensions (L x W x H)	Capacity per shelf	Colour	UPC
5267E	36 <sup>3</sup> / <sub>4</sub> x 25 x 36"	150 lbs.	● Grey	063636752675



### Rubbermaid® Utility Cart

- 3 shelves
- Handles on both ends
- 4 swivel casters
- Middle and bottom shelves have inverted lips to contain products and prevent items from falling off
- Made of plastic and aluminum
- Available in grey, off-white and black

Item #	Dimensions (L x W x H)	Capacity per shelf	Colour	UPC
5400-01	40 <sup>1</sup> / <sub>2</sub> x 20 x 37 <sup>3</sup> / <sub>4</sub> "	100 lbs.	○ White	063636754006

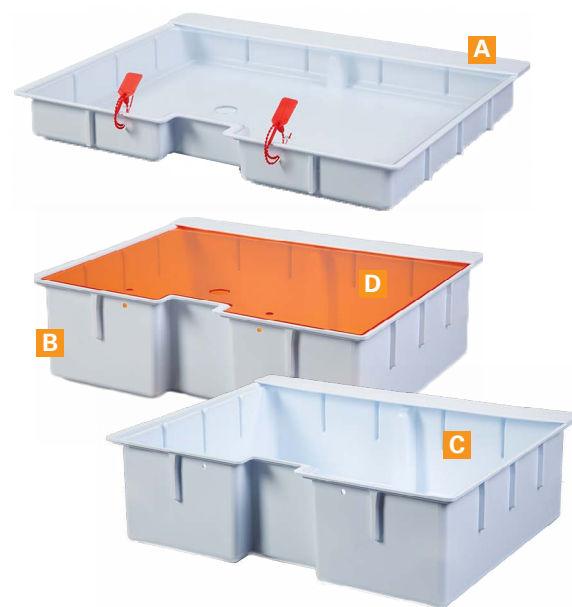

### Metro Lifeline Crash Cart Boxes

- Designed to fit Metro Lifeline Crash Cart drawers
- Ideal for organizing medications and supplies in the drawer
- Designed for easy removal and access during a "code" situation as well as ensuring the replenishing of stock
- Compatible with security seals for added security (sold separately)
- Dividers and foam are available for customization (sold separately)
- Shallow box measures: 19" W x 2<sup>1</sup>/<sub>2</sub>" H x 15"
- Deep box measures: 19" W x 5<sup>1</sup>/<sub>2</sub>" H x 15"

Item #	Size	Description	UPC
1873-01	A Shallow	Box with Clear Slide-In Lid	063636187316
1870-01	Shallow	Box (only)	063636187019
1876-01	B Deep	Box with Clear Slide-In Lid	063636187613
1875-01	Deep	Box (only)	063636187514
1872-01	C -	Clear Slide-In Lid (only)	063636187217
1871-01	D -	Amber Slide-In Lid (only)	063636187118

### Rubbermaid® Large Utility Carts & Accessories

- Versatile, functional carts for easy transport
- Easy-to-clean smooth surfaces
- Strong, lightweight designs
- Quiet casters and plastic construction help eliminate noise
- Convenient handle on each end assists in complying with HACCP guidelines
- Made of plastic
- Small or large waste bin attachment, available separately

Item #	Details	Dimensions (L x W x H)	Capacity	Colour	UPC
5261S	A Utility cart	31 <sup>1</sup> / <sub>2</sub> x 16 <sup>1</sup> / <sub>4</sub> x 37"	200 lbs.	Off-White	063636752613
5261P	Utility cart	31 <sup>1</sup> / <sub>2</sub> x 16 <sup>1</sup> / <sub>4</sub> x 37"	200 lbs.	Platinum	063636752613
5254	Small waste bin	9 x 13 x 8"	15.1 L	Black	063636752545



### Stainless Steel Bench with Storage

- Easy-to-Clean - Provides a hospital-grade seating solution in cleanroom gowning areas. Allows user to sit while donning appropriate cleanroom attire
- Sturdy - 16-gauge stainless steel for durability and long life. Includes 8 storage compartments and 6 dividers for PPE apparel
- Adjustable - Feet provide up to 3" of additional height
- Weight Capacity - 750 lbs

Item #	Dimensions (W x H x D)	UPC
19546	36 x 19 x 18"	063636195465

### Equipment Tags

- Status Indication - Cardstock tags allow users to easily indicate product status. Use to identify items such as carts, trays or scales that have been cleaned or repaired and are ready for use.
- Ready to Use - Wire ties (included) easily attach tags to nearly any item.
- Quantity - 50 per pack
- Dimensions - 2<sup>5</sup>/<sub>16</sub>" W x 4<sup>3</sup>/<sub>4</sub>" H

Item #	Description	Colour	UPC
20745	B Equipment Tags, Clean	Green	063636207458
20746	C Equipment Tags, Dirty	Red	063636207465
20747	Equipment Tags, Blank	Ivory	063636207472

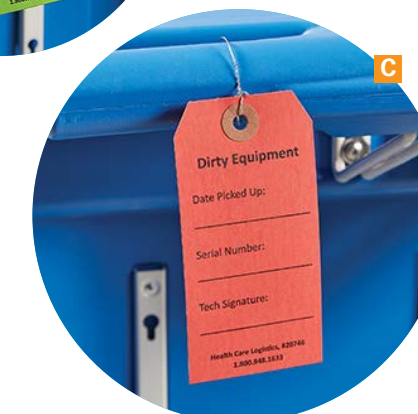



**Stainless Steel Carts**

Item #	Shelves	Casters	Shelf Clearance	Dimensions (W x H x D)	Capacity	Assembly Required	UPC	
18751	<b>A</b>	2	4 Swivel	25"	36 x 34 x 22"	600 lbs.	Yes	063636188511
18752	<b>B</b>	3	4 Swivel	11"	36 x 34 x 22"	600 lbs.	Yes	063636187521
18753	<b>C</b>	4	4 Swivel, 2 Locking	12"	36 x 48 x 22"	600 lbs.	Yes	063636187538
5295	<b>D</b>	3	4 Swivel, 2 Locking	11 <sup>3</sup> / <sub>4</sub> "	33 x 32 <sup>1</sup> / <sub>2</sub> x 17 <sup>1</sup> / <sub>4</sub> "	600 lbs.	Yes	063636752958
17827	<b>E</b>	3	4 Swivel, 2 Locking	10 <sup>1</sup> / <sub>2</sub> "	29 <sup>1</sup> / <sub>2</sub> x 35 <sup>7</sup> / <sub>16</sub> x 15 <sup>3</sup> / <sub>4</sub> "	200 lbs.	No	063636178277
11875	<b>F</b>	3	4 Swivel	10 <sup>7</sup> / <sub>8</sub> "	27 <sup>1</sup> / <sub>2</sub> x 33 <sup>3</sup> / <sub>8</sub> x 16 <sup>1</sup> / <sub>4</sub> "	300 lbs.	No	063636711863
11876	<b>G</b>	3	4 Swivel	8 <sup>1</sup> / <sub>2</sub> "	18 <sup>3</sup> / <sub>4</sub> x 30 <sup>1</sup> / <sub>8</sub> x 16 <sup>3</sup> / <sub>4</sub> "	200 lbs.	No	063636711856

Guard rail around cart shelves prevents cart items from sliding off during transport

**Crash Cart Boxes with Handle**

- Built-in handle allows for easy access in cart or when carried to and from supply areas or alternate care sites
- Boxes and dividers can be colour-coded by department, medication, age group, supplies, floors, units, etc.
- Amber or clear slide-in lids are available with the boxes or individually
- Dividers will provide greater organization and accessibility of supplies (sold separately)
- Holes on boxes allow security seals to be used for control and documentation (sold separately)
- Available in ● blue, ● light blue, ● green, ● red, ● yellow and ○ white – specify colour when ordering
- Full-size measures: 21<sup>3</sup>/<sub>4</sub>" W x 2<sup>5</sup>/<sub>8</sub>" H x 15<sup>1</sup>/<sub>4</sub>" D
- Half-size measures: 10<sup>5</sup>/<sub>8</sub>" W x 2<sup>5</sup>/<sub>8</sub>" H x 15<sup>1</sup>/<sub>2</sub>" D

Item #	Size	Description	Lid Colour	UPC
1867	Full	Box (only)	-	063636718671
1868	Full	Slide-In Lid (only)	○ Clear	063636718688
3132	Half	Box with Slide-In Lid	● Amber	063636731328
3131	Half	Box (only)	-	063636731311
3133	Half	Slide-In Lid (only)	○ Clear	063636731335

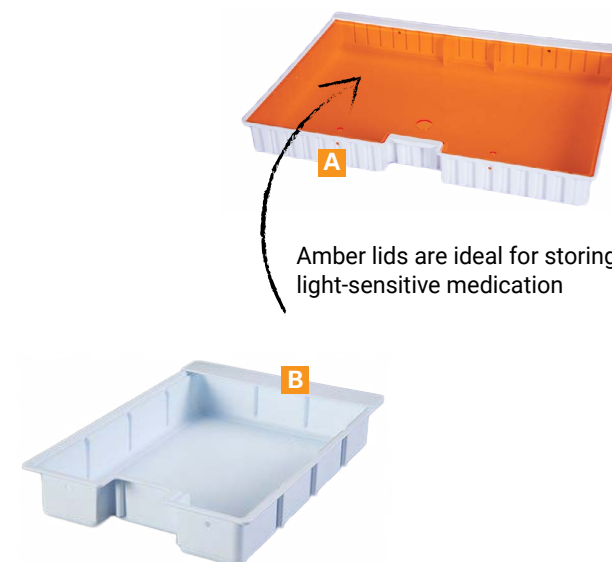

**Crash Cart Boxes**

- Enhanced durability, made of impact-resistant polystyrene plastic
- Design includes built-in handle for easy gripping
- Available with two styles of lids: Slide-in (more durable) or Lift-off lids (easier to remove in a code procedure)
- Slide-in lids are available in clear or amber; lift-off lids are available in clear (amber meets light resistance specifications)
- Crash cart security bags can be used instead of, or in addition to lids
- Lids can be secured using pull-tight seals
- Add dividers to maximize organization and supply accessibility
- Full-size box measures: 21<sup>3</sup>/<sub>4</sub>" W x 2<sup>5</sup>/<sub>8</sub>" H x 15<sup>1</sup>/<sub>4</sub>" D
- Half-size box measures: 10<sup>5</sup>/<sub>8</sub>" W x 2<sup>5</sup>/<sub>8</sub>" H x 15<sup>1</sup>/<sub>2</sub>" D

Item #	Size	Description	Lid Colour	UPC
1816	Full	Box with Slide-In Lid	○ Clear	063636718169
1850	<b>A</b>	Full	● Amber	063636718503
1817	Full	Box with Lift-Off Lid	○ Clear	063636718176
1814	Full	Box (only)	-	063636818272
1819	Full	Lift-off Lid (only)	○ Clear	063636718190
1101	Full	Dividers: 3 long, 4 short (Creates up to 20 compartments)	○ White	063636811013
3020	<b>B</b>	Half	For use with Slide-in Lid	063636730208
3001	Half	Box with Lift-off Lid	○ Clear	063636830007
3013	Half	Box (only) For use with Lift-off Lid	-	063636730130

### Cut Foam Options

- Organize Contents: Customize transport boxes, med kits, crash carts, trays, drawers and more so contents are easy to identify. Helps protect items from possible breakage.
- Die Options & Cut to Your Design: Different die shapes are available for ampules, vials, boxes and other special shapes (may require additional one-time charge for a cutting die). Send us your layout and we'll cut the foam to your specification.
- Details: There is a design charge to create the template. We will send a proof for approval prior to completing the order.
- Fast Shipping: most orders ship in 5 working days from approval of final layout drawing



### Pinch & Pull Foam Grid Pads

- Customize - Pull out the prescored 1/2" cubes to create spaces as needed
- Prevent Breakage - Quick and affordable way to protect and organize vials, bottles, boxes, etc. in cart drawers, boxes, and more

Item #	Description	Dimensions (W x H x D)	UPC
1926-01	<b>A</b> Pinch & Pull Foam Grid pad, 1 1/4" H	16 x 1 1/4 x 12 1/8"	063636719265
1975-01	<b>B</b> Pinch & Pull Foam Grid pad, 2" H	16 x 2 x 12 1/8"	063636719753

### Amber Security Bags for Full-Size Crash Cart Boxes

- Easy to Identify - Bags are pre-printed with white letters that state ATTENTION: PEDIATRIC ONLY. These bags allow crash cart boxes to be quickly identified.
- Convenient - Self-sealing adhesive closure. Perforated opening cannot be resealed once opened. Tears may indicate discrepancy in kit contents.
- Quick Retrieval - In code situations, bags open easily and quickly by tearing at the highlighted perforations.
- Perforations - 1 center, 1 end
- UV Light Blockage - Amber security bags will protect light sensitive medications.
- Thickness - 2-mil
- Quantity - 20 per pack



Item #	Description	Dimensions (W x H)	UPC
7534	<b>C</b> Attention Pediatric Only	29 x 20"	063636075347
7535	<b>D</b> Attention Adult Only	29 x 20"	063636075354

### Self-Sealing Crash Cart Bags

- Self-sealing, tamper evident – simply remove paper strip at top to access adhesive; fold over to seal bag
- Bags can be easily opened by tearing the highlighted perforations - ideal for quick access or code situations
- A tear in the bag indicates prior emergency or tampering
- 2 mil thick
- 20 per package



Item #	Description	Perforation	Dimensions (W x H)	Colours	UPC
1714	Security Bags for Deep Metro® Lifeline™ & Waterloo® CCB	1 center	31 x 21 1/2"	Clear	063636717148
19840	Amber Security Bags for Deep Metro® Lifeline™ & Waterloo® CCB	1 center	31 x 21 1/2"	Amber	063636198404
7512	Security Bags for Full-Size CCB	1 center	29 x 20"	Clear	063636775124
20501	<b>A</b> Amber Security Bags for Full-Size CCB	"H"	29 x 30"	Amber	
7505	Security Bags for Full-Size CCB	"H"	29 x 20"	Clear	063636775056
7515	Security Bags for Full-Size CCB	1 center, 1 end	29 x 20"	Clear	063636775155
7509	Security Bags for Full-Size CCB w/ Blue Border	1 center, 1 end	29 x 20"	Clear/Blue	063636775094
7510	Security Bags for Full-Size CCB w/ Red Border	1 center, 1 end	29 x 20"	Clear/Red	063636775100
7568B	Security Bags for Full-Size CCB Blue or Red	1 center, 1 end	29 x 20"	Blue	063636075682
7568R	Security Bags for Full-Size CCB Blue or Red	1 center, 1 end	29 x 20"	Red	063636756888
7506	Amber Security Bags for Full-Size CCB	1 center, 1 end	29 x 20"	Amber	063636775063
7534	Attn: Pediatrics Only Amber Security Bags for Full-Size CCB	1 center, 1 end	29 x 20"	Amber	063636075347
7535	Attn: Adult Only Amber Security Bags for Full-Size CCB	1 center, 1 end	29 x 20"	Amber	063636075354
7517	<b>B</b> Security Bags for Half-Size CCB	1 center	22 x 14"	Clear	063636775179
7502	Amber Security Bags for Half-Size CCB	1 center, 1 end	22 x 14"	Amber	063636775025
7500	Security Bags for Blue Bell CCB	1 center	18 1/2 x 15 1/2"	Clear	063636775001
7503	Security Bags for Top Compartment Metro® Lifeline™ CCB	1 center	21 1/2 x 20"	Clear	063636775032

Cart Box Item #	Security Bag Item #															
	1714	19840	7512	20501	7505	7515	7509	7510	7568	7506	7534	7535	7517	7502	7500	7503
Shallow CC Box 1870-01, 3215			✓		✓	✓	✓	✓	✓	✓	✓	✓				
Deep CC Box 1875-01, 3219	✓	✓														
Full-Size CC Box 1814 & 1867			✓	✓	✓	✓	✓	✓	✓	✓	✓	✓				
Third-Size CC Box 3150													✓	✓	✓	
Half-Size CC Box 3020, 3013, 3131													✓	✓	✓	
Metro Top Compartment CC Box 3057 & 3211																✓

### Thermometers with glycol-filled bottle probes

- Recommended to meet the National Vaccine Storage and Handling Guidelines
- 10 ml & 5 ml glycol bottle probes insulate sensors from rapid temperature changes, ideal for mimicking vaccine temperatures



### Thermometers with enclosed temperature buffered ambient sensor probes

Ideal for the following:

- Freezers
- Water baths
- Heating blocks
- Incubators
- Refrigerators



Item #	Description	5 ml Probes	10 ml Probes	Ambient Probes	Resolution	Accuracy	Current/Min./Max. Temp. (with reset button)	Ambient Room Temp.	High/Low Alarm	Calibration Certificate	Low Battery Icon
10364	TraceableLive® Wifi Datalogging Thermometer		✓		0.01°C	± 0.25°C	✓		✓	✓	✓
14140	Traceable® Refrigerator/Freezer Thermometer		✓		0.1°C	±0.5°C	✓	✓	✓	✓	✓
14141	Traceable® Digital Humidity/Temperature Meter				1°C	±1°C			✓		
14144	Traceable® Refrigerator/Freezer Thermometer	✓			1°C	±1°C	✓	✓	✓	✓	✓
10366	Traceable® Dual Thermometer			✓	1°C	±1°C	✓	✓	✓	✓	✓
10367	Traceable® Refrigerator/Freezer Thermometer			✓	1°C	±1°C	✓	✓	✓	✓	✓
10368	Traceable® Refrigerator/Freezer Thermometer		✓		1°C	±1°C	✓	✓	✓	✓	✓
10369	Traceable® Dual Bullet Probe Thermometer			✓	0.1°C	±1°C	✓	✓	✓	✓	✓
17751	Traceable® Jumbo Thermometer		✓		0.1°C	±1°C	✓	✓	✓	✓	✓
17752	Traceable® Jumbo Thermometer	✓			0.1°C	±1°C	✓	✓	✓	✓	✓
17750	Traceable® Jumbo Thermometer			✓	0.1°C	±1°C	✓	✓	✓	✓	✓
17988	Traceable® High-Accuracy Thermometer		✓		0.01°C	±0.3°C	✓		✓	✓	✓
17989	Traceable® High-Accuracy Thermometer, dual probe		✓		0.01°C	±0.3°C	✓		✓	✓	✓
17990	Traceable® High-Accuracy Thermometer, dual probe			✓	0.01°C	±0.3°C	✓		✓	✓	✓
19195	Traceable® Memory-Loc™ Datalogger, single probe		✓		0.01°C	±0.25°C	✓		✓	✓	✓
19196	Traceable® Memory-Loc™ Datalogging Thermometer, dual probe		✓		0.01°C	±0.25°C	✓		✓	✓	✓
19197	Traceable® Excursion-Trac® Datalogger, single probe		✓		0.01°C	±0.25°C	✓		✓	✓	✓
19198	Traceable® Excursion-Trac™ Thermometer, dual probe		✓		0.01°C	±0.25°C	✓		✓	✓	✓
19465	Fridge-Tag® Storage Temperature Monitor with USB			✓	0.1°C	±0.5°C	✓		✓	✓	✓

### Vaccine Temperature Monitoring Requirements:

- The National Vaccine Storage and Handling Guidelines (2015), as well as many provincial guidelines, require manual documentation of vaccine temperatures, where the: current, minimum and maximum refrigerator temperatures, and the ambient room temperature must be recorded at the beginning and end of each day (min/max temperatures must be reset after each recording) – log templates are available, refer to the guidelines, or contact us for assistance
- The digital display should be placed on the **outside** of the refrigerator (Ontario requires a display with a minimum resolution of 0.1° C), with the probe in the centre of the refrigerator (preferably in a vaccine box)
- Bottle probes (bio-safe glycol fluid bottle probes) are recommended for a more accurate reading
- Reset button required to reset the minimum and maximum temperature after each recording
- Thermometers should be set to alarm if temperatures fall to 3°C or rise to 7°C to signify approaching out of range
- Thermometers should be checked for calibration at least annually, and it is recommended they be calibrated within ±0.5°C (±1°F) of accuracy
- Thermometers should have a low battery indicator, and batteries should be replaced every 6 months



### General Vaccine Storage Requirements:

- ✓ Maintain required vaccine storage temperatures
- ✓ Hold sufficient inventory
- ✓ Have a calibrated **temperature-monitoring device** inside each storage compartment
- ✓ Refrigerator is dedicated to the storage of vaccines only
- ✓ Be placed in a secure location
- ✓ Recommended thermometer calibration should be accurate within **±0.5°C (±1°F)**
- ✓ Record refrigerator temperature twice daily
- ✓ Contact public health officials if vaccines are exposed to temperatures outside the recommended range



**Traceable® Thermometers:**

- Triple display simultaneously shows the current, minimum and maximum temperature reading
- Includes Traceable® certificate from ISO 17025 calibration laboratory, accredited by A2LA, valid for 1 year - recalibration is the customer's responsibility, contact us for assistance
- Alarm alerts when temperature rises or falls outside set point
- Low battery symbol indicates when batteries should be replaced
- Reads temperatures ranging from - 50° - 70° C (-58° - 158° F)
- Includes all necessary batteries and mounting equipment (flip stands, wall mounts, Velcro® and magnet strips)



Item #10369 is a dual bottle probe extension for item #10366

**Traceable® Thermometers**

- Reads the ambient room temperature as well as the external probe temperature using the in/out function
- Alarm programmable in 1° increments

Item #	Description	Probe Type	Dimensions (W x H x D)	UPC
14144	<b>A</b> Traceable® Refrigerator/Freezer Thermometer	5 mL Bottle Probe	2 <sup>3</sup> / <sub>4</sub> x 4 <sup>1</sup> / <sub>4</sub> x 3 <sup>3</sup> / <sub>4</sub> "	063636141448
10367	<b>B</b> Traceable® Refrigerator/Freezer Thermometer	Ambient Probe	2 <sup>3</sup> / <sub>4</sub> x 4 <sup>1</sup> / <sub>4</sub> x 3 <sup>3</sup> / <sub>4</sub> "	063636103675
10368	<b>C</b> Traceable® Refrigerator/Freezer Thermometer	10 mL Bottle Probe	2 <sup>3</sup> / <sub>4</sub> x 4 <sup>1</sup> / <sub>4</sub> x 3 <sup>3</sup> / <sub>4</sub> "	063636103682
17751	<b>D</b> Traceable® Jumbo Refrigerator/Freezer Thermometer	10 mL Bottle Probe	3 <sup>7</sup> / <sub>8</sub> x 4 <sup>3</sup> / <sub>8</sub> x 7 <sup>7</sup> / <sub>8</sub> "	063636177515
17752	Traceable® Jumbo Refrigerator/Freezer Thermometer	5 mL Bottle Probe	3 <sup>7</sup> / <sub>8</sub> x 4 <sup>3</sup> / <sub>8</sub> x 7 <sup>7</sup> / <sub>8</sub> "	063636177522
17750	<b>E</b> Traceable® Jumbo Refrigerator/Freezer Thermometer	Ambient Probe	3 <sup>7</sup> / <sub>8</sub> x 4 <sup>3</sup> / <sub>8</sub> x 7 <sup>7</sup> / <sub>8</sub> "	063636177508
14140	<b>F</b> Traceable® High Resolution Refrigerator/Freezer Plus™ Thermometer	10 mL Bottle Probe	3 <sup>1</sup> / <sub>4</sub> x 2 <sup>1</sup> / <sub>5</sub> x 5 <sup>5</sup> / <sub>8</sub> "	063636141400
10366	<b>G</b> Traceable® Dual Thermometer	2 10 ml Probes	3 <sup>1</sup> / <sub>2</sub> x 1 <sup>3</sup> / <sub>4</sub> x 1"	063636103668
10369	Traceable® Dual Bottle Probe Extension for #10366	2 Ambient Probes	3 <sup>1</sup> / <sub>2</sub> x 1 <sup>3</sup> / <sub>4</sub> x 1"	063636103668

**Traceable® High-Accuracy Refrigerator/Freezer Thermometer**

- Displays the exact time and date when the minimum and maximum temperature occurred
- Displays the exact time and date alarm is triggered
- Alarm programmable in 0.1° increments

**Traceable® Excursion-Trac® Datalogging Thermometer**

- Datalogging thermometer with user-defined time intervals
- Stores up to 10 unique alarm events - alarm tracking stores each alarm event, the time and date of occurrence
- Rolling memory structure maintains the most recent 525,000 observations, clear after downloading to USB flash drive (unit can remain in use while downloading data)
- Allows recorded data (CSV file) to be transferred from thermometer to PC or Mac using a USB flash drive (not included). No software is needed for computer interface. Each thermometer has a unique ID allowing multiple units to be used in the same location
- Status indicators show low battery, memory full, USB data transfer and active alarm state

**Traceable® Memory-Loc™ Datalogging Thermometer**

- Can be used in 21 CFR 11 environments – data is locked and cannot be cleared or changed on unit
- Fixed one minute logging intervals, for up to 2 years
- Stores up to 10 unique alarms - alarm tracking stores each alarm event, the time and date of occurrence
- Allows recorded data (CSV file) to be transferred from thermometer to PC or Mac using a USB flash drive (not included). No software is needed for computer interface. Each thermometer has a unique ID allowing multiple units to be used in the same location
- Status indicators show low battery, memory full, USB data transfer and active alarm state

Item #	Description	Probe Type	Dimensions (W x H x D)	UPC
17988	<b>A</b> Traceable® High-Accuracy Refrigerator/Freezer Thermometer	10 mL Bottle Probe	2 <sup>3</sup> / <sub>4</sub> x 4 <sup>1</sup> / <sub>4</sub> x 3 <sup>3</sup> / <sub>4</sub> "	063636179885
17989	<b>B</b> Traceable® High-Accuracy Refrigerator/Freezer Thermometer	10 mL Bottle Probes (2)	2 <sup>3</sup> / <sub>4</sub> x 4 <sup>1</sup> / <sub>4</sub> x 3 <sup>3</sup> / <sub>4</sub> "	063636179892
17990	<b>C</b> Traceable® High-Accuracy Refrigerator/Freezer Thermometer	Ambient Probes (2)	2 <sup>3</sup> / <sub>4</sub> x 4 <sup>1</sup> / <sub>4</sub> x 3 <sup>3</sup> / <sub>4</sub> "	063636177908
19197	<b>D</b> Traceable® Excursion-Trac® Datalogging Thermometer	10 mL Bottle Probe	2 <sup>3</sup> / <sub>4</sub> x 4 <sup>1</sup> / <sub>4</sub> x 3 <sup>3</sup> / <sub>4</sub> "	063636103705
19198	<b>E</b> Traceable® Excursion-Trac® Datalogging Thermometer	10 mL Bottle Probes (2)	2 <sup>3</sup> / <sub>4</sub> x 4 <sup>1</sup> / <sub>4</sub> x 3 <sup>3</sup> / <sub>4</sub> "	063636191986
19195	<b>F</b> Traceable® Memory-Loc™ Datalogging Thermometer	10 mL Bottle Probe	2 <sup>3</sup> / <sub>4</sub> x 4 <sup>1</sup> / <sub>4</sub> x 3 <sup>3</sup> / <sub>4</sub> "	063636103729
19196	<b>G</b> Traceable® Memory-Loc™ Datalogging Thermometer	10 mL Bottle Probes (2)	2 <sup>3</sup> / <sub>4</sub> x 4 <sup>1</sup> / <sub>4</sub> x 3 <sup>3</sup> / <sub>4</sub> "	063636191962

### Traceable® Digital Humidity/Temperature Meter

- Display - Continuously and simultaneously displays relative humidity and temperature in °F or °C.
- Min/ Max Display - Minimum and maximum memories may be displayed or cleared at any time with the touch of a button.
- Temperature Range - Temperature range is 0° to 50°C (32° to 122°F) and with a resolution of 1° and maintains an accuracy of ±0.1°C/±0.1°F. Humidity range is from 25 to 95%, resolution is 1% RH, and accuracy is ±2% RH mid-range to ±4% RH elsewhere.
- Solid State Sensors - Fast-response solid-state sensors display changes in less than 30 seconds. Display is updated once per second.
- NIST Certified - Includes individually serial-numbered Traceable® Certificate.
- Recalibration is the customer's responsibility and annual recalibration is recommended.
- Power - Includes 2 AAA batteries



Item #	Dimensions (W x H x D)	UPC
14141	2 <sup>5</sup> / <sub>8</sub> x 3 <sup>7</sup> / <sub>8</sub> x 5 <sup>5</sup> / <sub>8</sub> "	063636714147

### Alarm Thermometer

- Use for precise monitoring
- Reads temperatures from -50° - 70° C (-58° - 158° F), with an accuracy of ±0.1°C
- Four unique alarm configurations: when temperature is higher than set point, lower than set point, outside of high and low set points, or inside of high and low set points
- Continuous alarm sounds and blinks red and green every minute for five minutes until the temperature returns to non-alarm condition or until alarm is turned off
- 1 meter micro cable allows refrigerator doors to close on it
- Jumbo display is readable from 3 meters away
- Calibration is accredited by A2LA and meets NIST standards
- Made of high-impact, chemical-resistant ABS plastic



Item #	UPC
90711	063636707118

### Digital Clock/Timer

- Track Multiple Activities - Three distinctive alarms help eliminate confusion. Timer counts both up and down. The clock mode runs continuously.
- Use Anywhere - Built in clip, stand, magnet and hanging hole on back side.
- Wireless - One AAA battery included



Item #	Dimensions (W x H x D)	UPC
10461	3 x 2 <sup>1</sup> / <sub>2</sub> x 3 <sup>3</sup> / <sub>4</sub> "	063636707118

### Refrigerator/Freezer Thermometer

- Temperature Range - From -40°F to 120°F, -40°C to 50°C
- Display - Non-toxic, mercury-free thermometer
- Dimensions - 1<sup>1</sup>/<sub>16</sub>"W x 4<sup>1</sup>/<sub>2</sub>"H x 3<sup>3</sup>/<sub>8</sub>"D



Item #	UPC
3010	063636730109



### TraceableLive® Wifi Datalogging Thermometer

- Wireless Temperature Monitoring and more—connect to existing WiFi
- Alerts: temperature alarm, connectivity interruption, low battery
- Cloud-based data interface—no local software required; web, Android, Apple IOS data visibility
- Continuous data transmission and monitoring using SSL encrypted SECURE connection
- Receive MOBILE PUSH / E-MAIL / TEXT notifications
- Unlimited scalability—use TraceableLIVE® in individual labs or an entire network of facilities

Item #	UPC
10364	063636103644

### Fridge-Tag® Storage Temperature Monitor with USB

- Fridge-Tag 2L's direct display feature requires no software to quickly review 30 day's worth of data instantly.
- Monitors the temperature inside the unit to protect the integrity of temperature-sensitive drugs
- Dimensions - 5<sup>1</sup>/<sub>4</sub>"W x 2<sup>15</sup>/<sub>16</sub>"H x 9<sup>9</sup>/<sub>16</sub>"D



Item #	UPC
19465	063636194659

### Stainless Steel Refrigerator/Freezer & Dry Storage Thermometer

- Colour zones on dial indicate safe ranges and HACCP guidelines
- Reads temperatures from -30° - 30° C (20° - 80° F), with an accuracy of ±1°C
- Features attached hook for easy hanging or use base for free standing
- NSF certified



Item #	Measures	UPC
16087	2" diameter	063636160876

### Traceable® Long Probe Thermometer

- Reads temperatures from -50° - 300° C (-58° - 572° F), 0.1° resolution, accuracy of ±0.1°C
- Reading is updated every second
- Memory recalls previous min./max. readings
- Waterproof and shockproof - stainless steel probe is impervious to acids, bases, and solvents; can be inserted in a variety of solutions
- Includes Traceable® certificate to verify traceability standards
- Battery included (1.5V silver-oxide)



Item #	Dimensions (L x W x H)	UPC
10375	10 <sup>1</sup> / <sub>4</sub> x 1 <sup>3</sup> / <sub>4</sub> x 8" Long Probe	063636130756

Storage Information  
Labels can be found on  
page 135



### Undercounter Freestanding Refrigerator

- Units feature a digital microprocessor temperature controller allowing for the precise temperature management necessary for critical samples and supplies.
- A forced air directional refrigeration system provides superior temperature uniformity and recovery after door openings.
- Environmentally friendly, natural hydrocarbon (HC) refrigerants (not containing hydrofluorocarbons) vastly reduce global-warming potential (GWP) while meeting new EPA/SNAP mandates and UL, ASHRAE compliance guidelines.

#### Includes:

- Temperature controller
- Digital setting accuracy
- Precise temperature maintenance
- Monitoring and alarms
- High/low temperature alarm
- Sensor error alarm
- Alarm mute
- Remote contacts



Item #	Electrical	Volume	Dimensions (W x D x H)	Cycle	Door Type	No. of Shelves	UPC
REF303	115V, 60 Hz, 0.90A	71 L (2.5 cu. ft.)	17 <sup>3</sup> / <sub>4</sub> x 19 <sup>1</sup> / <sub>2</sub> x 28 <sup>7</sup> / <sub>8</sub> "	Defrost	1 Glass Swing	4 Adjustable	063636876296
REF304	<b>A</b> 115V, 60 Hz, 0.90A	51 L (1.8 cu. ft.)	17 <sup>1</sup> / <sub>4</sub> x 19 <sup>1</sup> / <sub>4</sub> x 21 <sup>1</sup> / <sub>4</sub> "	Defrost	1 Glass Swing	2 Adjustable	063636003043



### Freestanding Refrigerators

- Designed to enhance pharmaceutical storage and display experience to the highest standards of quality and performance.
- Self contained Cassette® forced-air refrigeration employs R290 hydrocarbon Natural
- Refrigerant within a sealed capillary tube system.
- Cassette® refrigeration is bottom-mounted and removable from the front for ease of maintenance. Refrigeration may be exchanged or upgraded without mechanic. Designed to hold 36°F to 46°F (2.2°C to 7.7°C).
- Equipped with Energy Efficient Digital Controller featuring visual/audible product protection alarm.
- Technologically advanced ProducTemp™ provides exterior product temperature display. Displays to a resolution of 0.1°.

Item #	Electrical	Volume	Dimensions (W x D x H)	Door Type	No. of Shelves	UPC
REF12C	<b>B</b> 115V/3.1 Amp/60 Hz	28 cu. ft	24 x 23 <sup>7</sup> / <sub>8</sub> x 62"	1 Glass Swing	4	063636120016
REF18C	<b>C</b> 115V/3.1 Amp/60 Hz	35 cu. ft	24 x 23 <sup>7</sup> / <sub>8</sub> x 78"	1 Glass Swing	7	063636180010
REF46H	<b>D</b> 115V/4.3 Amp/60 Hz	78 cu. ft	47 <sup>1</sup> / <sub>2</sub> x 31 x 78"	2 Glass Swing	10	063636460013

### Stainless Steel Locking Refrigerator Storage Boxes

- Ideal solution for areas that cannot accommodate full-sized locking refrigerators self-locking nuts and bolts to refrigerator shelves
- Featured pre-drilled holes to use with security seals
- All locks (except padlocks) come keyed differently on a master key system; contact us for keyed alike options
- Select from styrene drawers, or acrylic (to view contents, noted below)
- Outside box measures: 5<sup>3</sup>/<sub>4</sub>"W x 4<sup>1</sup>/<sub>4</sub>"H x 11<sup>1</sup>/<sub>4</sub>"D
- Inside box measures: 5<sup>3</sup>/<sub>16</sub>"W x 3"H x 10<sup>9</sup>/<sub>16</sub>"D
- Made of 18-gauge stainless steel
- **Note:** Acrylic drawers cannot be used with security seals or dividers

Item #	Description	UPC
3725	<b>A</b> Key Lock	063636372514
3726	<b>B</b> Slam Lock or Padlock	063636372613
3735	<b>C</b> Acrylic drawer with key lock	063636373511



### Deluxe Refrigerator Boxes

- Secure - Easily organize and store temperature-sensitive medication in these lockable, tamper-proof refrigerator boxes
- Durable - PETG construction means boxes have superior impact qualities for years of everyday use
- Prevents Rolling - Roll stop lip prevents contents from rolling beyond the edge of the box.

Item #	Description	Dimensions (W x H x D)	UPC
17844	<b>D</b> Deluxe Compact Refrigerator Box, KEDL	8 <sup>1</sup> / <sub>8</sub> x 3 <sup>1</sup> / <sub>2</sub> x 4 <sup>13</sup> / <sub>16</sub> "	063636178444
17524	<b>E</b> Deluxe Refrigerator Box, Key Lock	15 <sup>3</sup> / <sub>16</sub> x 3 <sup>1</sup> / <sub>2</sub> x 7 <sup>5</sup> / <sub>8</sub> "	063636175245
17526	<b>F</b> Deluxe Compact Refrigerator Box, Double Key Lock	8 <sup>1</sup> / <sub>8</sub> x 3 <sup>1</sup> / <sub>2</sub> x 41 <sup>3</sup> / <sub>16</sub> "	063636175269

### Rugged Refrigerator Boxes

- Secure - Easily organize and store temperature-sensitive medication in these lockable, tamper-proof refrigerator boxes
- Durable - Boxes are made of rugged polycarbonate material that provides extra durability for years of everyday use.
- Prevents Rolling - Roll stop lip prevents contents from rolling beyond the edge of the box.
- Maintain storage capacity - No tools required for assembly. Because there is no obtrusive mounting fixtures, the boxes take virtually no space away from the shelves above them
- Dimensions - 10<sup>1</sup>/<sub>16</sub>"W x 3<sup>7</sup>/<sub>8</sub>"H x 5<sup>1</sup>/<sub>4</sub>"D

Item #	Description	UPC
18907	<b>A</b> Rugged Refrigerator Box, Key Lock	063636189075
18908	Rugged Refrigerator Box, KEDL	063636189082
18909	<b>B</b> Rugged Refrigerator Box, Dial Combination	063636189099
19166	Rugged Refrigerator Box, Key Lock, Amber	063636191665
19167	<b>C</b> Rugged Refrigerator Box, KEDL, Amber	063636191672

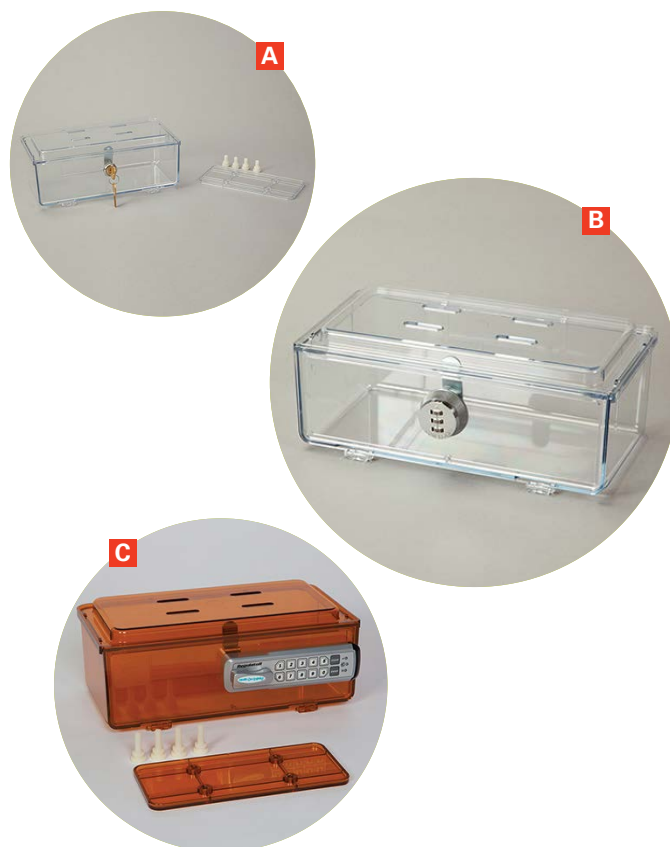

### Locking Refrigerator Boxes, Tilting & Non-Tilting

- Secure - Acrylic locking refrigerator boxes organize and secure temperature-sensitive medications.
- Multiple Lock Styles - Available in two locking styles: Key Lock or Keyless Entry Digital Lock.
- Dimensions - 12<sup>3</sup>/<sub>8</sub>"W x 4<sup>3</sup>/<sub>8</sub>"H x 12<sup>3</sup>/<sub>16</sub>"D

Item #	Description	UPC
18541	<b>D</b> Tilting Refrigerator Box, Key Lock	063636185411
18544	Non-Tilting Refrigerator Box, Key Lock	063636185442



### Locking Refrigerator Storage Boxes

- Ideal for use in facilities without access to locking refrigerators
- Ideal for controlling substances under single or double locks
- Lids can be affixed to refrigerator shelves (includes mounting brackets, nuts and bolts)
- Storage boxes function as a locked refrigerator drawer – once affixed to refrigerator shelves, boxes slide out from unlocked lid
- Tough, durable polyethylene construction
- Available in ● grey, ● light blue, or ● red – please specify colour when ordering

Item #	Description	Inside Dimensions (W x H x D)	UPC
3712	<b>E</b> Single Lock	6 <sup>1</sup> / <sub>2</sub> x 2 x 9 <sup>1</sup> / <sub>8</sub> "	063636737122
3713	Single Lock	6 <sup>1</sup> / <sub>2</sub> x 3 x 9 <sup>1</sup> / <sub>8</sub> "	063636737139
3714	<b>F</b> Single Lock	6 <sup>1</sup> / <sub>2</sub> x 4 <sup>1</sup> / <sub>2</sub> x 9 <sup>1</sup> / <sub>8</sub> "	063636737146

### Hinged Locking Refrigerator Boxes

- Ideal for use in facilities without access to full-size or locking refrigerators
- Self-locking nuts and bolts cannot be removed unless unit is open and unlocked – ensures safe and secure control over substances
- Available with single, double, or combination keyless locks
- Mounting accessories included

Item #	Size	Dimensions (L x W x H)	Lock	UPC
3746-01	<b>A</b> Compact	8 <sup>3</sup> / <sub>8</sub> x 2 <sup>7</sup> / <sub>8</sub> x 4 <sup>1</sup> / <sub>2</sub> "	Single Lock	063636374600
3747-01	Compact	8 <sup>3</sup> / <sub>8</sub> x 2 <sup>7</sup> / <sub>8</sub> x 4 <sup>1</sup> / <sub>2</sub> "	Double Lock	063636374709
3748-01	Small	12 x 4 <sup>1</sup> / <sub>2</sub> x 6"	Single Lock	063636374808
3749-01	<b>B</b> Small	12 x 4 <sup>1</sup> / <sub>2</sub> x 6"	Double Lock	063636374907
17843	<b>C</b> Small	12 x 4 <sup>1</sup> / <sub>2</sub> x 6"	Keyless Entry Digital Lock	063636178437

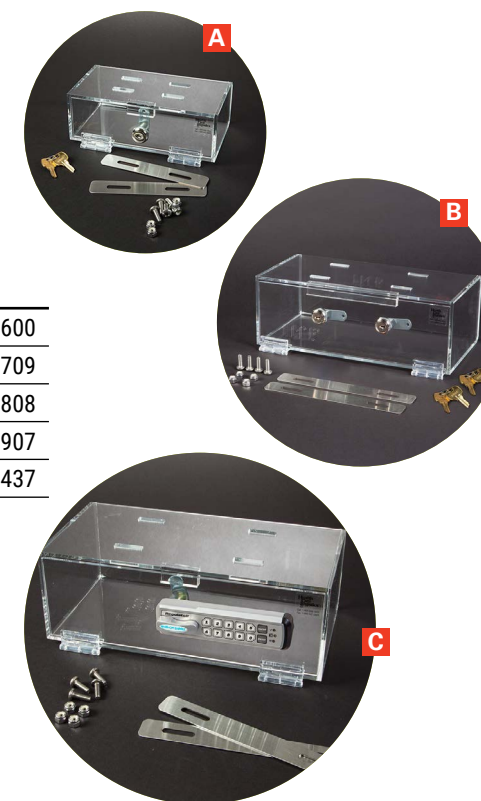

### Two-Sided Tape for all Refrigerator Boxes

- Flexibility - Mount refrigerator boxes virtually anywhere. Double-sided tape works great on carts, countertops, in narcotic safes or anywhere a small box may be needed.

Item #	Dimensions (W x L)	UPC
9934	4 x 11"	063636099343

### Refrigerate Zippit Bag

- Preprinted Message - Alert users to temperature sensitive contents.
- Thickness - 2.5-mil
- Closure - Reclosable zipper

Item #	Size	Qty	UPC
7629-10	5 x 8"	100	063636876296
18239	3 x 5"	100	063636182397
19547	12 x 15"	100	063636195472



### MonitorMark™ Product Exposure Indicators

- Ideal for use when transporting temperature-sensitive items
- Tags monitor temperature by changing colour to visually depict if acceptable temperature limit has been exceeded
- Records time exposed to unacceptable temperatures
- If an item can tolerate limited exposure to elevated temperatures, the results on the tags will help determine whether to accept or reject the item
- When the maximum temperature of the tag is exceeded, a blue colour appears in the window furthest to the left
- Colour change is irreversible
- Attaches with an adhesive back to most clean, dry surfaces
- Measures : 3 7/8 x 3/4"
- 10 per package



Item #	Temperature Range	Exposure Time	UPC
8201-01	5°C (41°F) and above	48 Hours	063636820114
8205-01	10°C (50°F) and above	48 Hours	063636820510
8207-01	10°C (50°F) and above	1 Week	063636820718
8208-01	31°C (88°F) and above	1 Week	063636820817



### Insulated Boxes

- Disposable, lightweight cooler to transport and ship temperature-sensitive items
- Leak-resistant gusseted liner made from FDA-approved materials
- Liner's adhesive lip tape seals the contents for maximum protection
- Boxes are shipped flat; each has instructions for assembly

Item #	Dimensions (W x H x D)	Qty	UPC
17878	8 x 8 x 8"	5	063636178789

### Insulated Transport Boxes

- Cost Effective - Keep medications at a stable temperature during transport.
- Protects Drug Integrity - 1 1/2" thick insulated walls are ideal for transporting 24 to 48-hour shipments.

Item #	Dimensions (W x H x D)	Qty	UPC (063636)
19808	11 x 10 x 9	1	063636198084
19807	15 1/2 x 12 x 15 1/2	1	063636198077



### Route of Administration

Item #	UPC	Route of Administration
1-11G	663104 001115	FOR EXTERNAL USE ONLY
1-14G	663104 001146	NOT TO BE TAKEN BY MOUTH
1-18G	663104 001184	FOR THE eye
1-25G	663104 001252	FOR THE NOSE
1-26G	663104 001269	FOR THE ear
2520	663104 025203	FOR INHALATION ONLY
1-51G	663104 001511	FOR ORAL USE ONLY
1-52G	663104 001528	NOT FOR INJECTION
1-72G	663104 001726	FOR VAGINAL USE ONLY
1-78G	663104 001788	for rectal use ONLY
1-393	663104 003935	FOR IRRIGATION ONLY
2155	063636 021559	FOR EPIDURAL USE ONLY
LPH-4	063636 140007	Intrathecal Use
LPH-5	063636 150006	Intramuscular Use
LPH-12	063636 012007	Subcutaneous Use
LPH-13	063636 013004	subcutaneous
AHSPT032	063636 000325	For Intravenous/Subcutaneous Use only/Fatal if given by other routes
LPH-68	063636 006808	PATCH
LPH-82	063636 000820	May be Fatal if Given by Other Routes
LPH-173	063636 001735	Fatal if given by other routes
LPH-107	063636 001070	AVOID EXTRAVASATION
AHSPT036	063636 000356	FOR IM USE ONLY
AHSPT036	063636 000363	FOR CARDIAC USE ONLY
AHSPT040	063636 040000	For Epidural Use Only
LPH-19	063636 019006	Epidural/Perineural Use

### Administration/Instruction Labels

Item #	UPC	Label
1-10G	663104 001108	SHAKE WELL
1-40G	663104 001405	SHAKE WELL AND KEEP IN REFRIGERATOR
1-49G	663104 001498	SHAKE WELL BEFORE USING
AHSPT031	063636 000318	SHAKE WELL
2522	063636 025229	DO NOT SHAKE
1-57G	663104 001573	DO NOT CHEW OR CRUSH. SWALLOW WHOLE
1-58G	663104 001580	CHEW TABLETS BEFORE SWALLOWING
1-75G	663104 001757	use as a gargle NOT TO BE SWALLOWED
1-316	663104 003164	DILUTE BEFORE ADMINISTRATION
1-328	663104 003287	DO NOT CRUSH
P-10	663104 008107	TAKE AFTER FOOD
P-30	663104 300003	SHAKE GENTLY BEFORE USING
1-98G	663104 001986	DIRECTIONS CHANGED REFER TO CHART
1-330	663104 003300	APPLY PATCH TO A CLEAN, DRY, HAIR-FREE AREA OF THE SKIN. ALTERNATE THE APPLICATION AREA WITH EACH CHANGE.
1-334	663104 003348	SHAKE WELL BEFORE USING. CLEAN MOUTHPIECE AFTER EACH USE WITH RUNNING WATER.
1-339	663104 003393	REFRIGERATE-SHAKE WELL Good for 14 days only
1-358	663104 003584	DO NOT SHAKE BEFORE SPRAYING. DO NOT INHALE SPRAY
1-389	663104 003898	USE SPARINGLY AND RUB IN WELL TO ALL AFFECTED AREAS.
1-669	663104 006691	Rinse mouth thoroughly after each use
2287	663104 022875	RECONSTITUTE BEFORE USE
LPH-1	663104 111012	INFUSE ENTIRE CONTENTS FOR FULL DOSE
LPH-72	063636 000721	REMOVE FOIL BEFORE ADMINISTRATION
LPH-78	063636 000783	WEAR GLOVES DO NOT CRUSH
LPH-128	063636 001285	WEAR NITRILE GLOVES DO NOT CRUSH OR SPLIT TABLETS OR OPEN CAPSULES
LPH-138	063636 001384	NOT FOR SELF-ADMINISTRATION
AHSPT017	063636 111717	RETURN any unused MEDICATION to the Pharmacy from which it was issued.
AHSPT025	063636 110253	DO NOT ADMINISTER WITH ACIDIC FOODS/SUBSTANCES

### Administration/Instruction Labels

Item #	UPC	Label
LPH-24	063636 024000	
CL-263	063636 002633	

### Dosing Frequency

Item #	UPC	Label
1-344	663104 003447	
1-345	663104 003454	
1-795	663104 007957	
1-796	663104 007964	
1-348	663104 003485	
1-349	663104 003492	
1-350	663104 003508	
1-351	663104 003515	
1-375	663104 003751	
1-436	663104 004369	
LPH-218	063636 002183	

### Dietary Information Labels

Item #	UPC	Label
1-326	663104 003263	
1-333	663104 003331	
1-338	663104 003386	
1-353	663104 003539	
1-354	663104 003546	
1-603	663104 006035	
5X	663104 000057	
1-671	663104 006714	
1-690	663104 006905	
1-47G	663104 001474	
1-66G	663104 001665	
1-74G	663104 001740	

### Dietary Information Labels

Item #	UPC	Label
P-10	663104 008107	
10X	663104 000101	
4X	663104 000040	

### Expiration Discard Labels

Item #	UPC	Label
1-28G	663104 001283	
1-35G	663104 001351	
1-320	663104 003201	
1-369	663104 003690	
2115	063636 021153	
1-370	663104 003706	
P-19	663104 190000	
P-21	663104 210005	
LPH-8	063636 018009	
LPH-217	063636 002176	
P-26	663104 260000	
2764	663104 027641	
18326	063636 183264	
LPH-91	063636 000912	
LPH-95	063636 000950	
LPH-169	063636 001698	
AHSPT041	063636 000417	
18225	063636 182250	

### Warning Labels

Item #	UPC	Label
1-16G	663104 001160	
1-19G	663104 001191	
1-60G	663104 001603	
1-63G	663104 001634	
1-70G	663104 001702	
15W	663104 000156	
1-76G	663104 001764	
1-83G	663104 001832	
1-95G	663104 001955	
8X	663104 000088	
2611	663104 726119	
1-360	663104 003607	
1-332	663104 003324	
1-601	663104 006011	
1-604	663104 006042	
1-673	663104 006738	
11X	663104 000118	
P-2	663104 200006	
1X	663104 000019	
P-60	663104 060006	
2722	663104 027221	
1-88G	663104 001887	
P-1	663104 002426	
2290	663104 022905	
P-32	063636 320010	
LPH-26	063636 026004	
LPH-6	063636 160005	
LPH-14	063636 014001	

### Warning Labels

Item #	UPC	Label
17519	063636 175191	
2911	063636 029111	
13-2	063636 001322	
P-34	063636 340001	
LPH-105	663104 101105	
2766	063636 027667	
LPH-17	063636 017002	
CL-1526	063636 015268	
CL-1182	063636 011826	
LPH-37	063636 003708	

### Caution Labels

Item #	UPC	Label
BHL4X4	063636 706661	
1-376	663104 003768	
13-3	063636 113308	
1-16G	663104 001160	
1-387	663104 003874	
P-22	663104 220004	
P-24	663104 240002	
12-384	663104 123848	

### Caution Labels

Item #	UPC	Label
LPH-85	063636 000851	
LPH-90	063636 009007	
LPH-174	063636 001742	
2373	063636 023737	
2374	063636 023744	
2372	063636 023720	
2290	663104 022905	
2291	663104 022912	
18595	063636185954	
LPH-77	063636 000776	
LPH-84	063636 000844	
LPH-106	063636 001063	
LPH-210	063636 002107	
LPH-123	063636 012304	
LPH-125	063636 001254	
LPH-126	063636 001261	
CL-664	063636 006648	
LPH-176	063636 001766	
LPH-227	063636 002275	
PCT-8	063636 000813	
AHSPT039	063636 110390	
AHSPT04	063636 111045	

### Caution Labels

Item #	UPC	Label
AHSPT05	063636 000059	
AHSPT047	063636 000479	
AHSPT048	063636 000486	
AHSPT049	063636 000493	
AHSPT050	063636 500009	
AHSPT051	063636 000516	
AHSPT055	063636 000554	
AHSPT06	063636 111069	
AHSPT07	063636 111076	
AHSPT023	063636 110239	
LPH-232	063636 002329	
LPH-76	063636 000769	
AHSPT08	063636 111083	
AHSPT09	063636 000097	
AHSPT037	063636 000370	
AHSPT010	063636 110109	
AHSPT024	063636 110246	

### Allergy Labels

Item #	UPC	Label
2889	063636 028893	
AHSPT034	063636 000349	
LPH-208	063636 020804	
LPH-215	063636 021504	

Item #	UPC	Label
1-15G	663104 001153	
1-324	663104 003249	
P-5	663104 500007	
P-12	663104 008121	
P-13	663104 130006	
2281	663104 022813	
2280	063636 022808	
LPH-239	063636 023904	
2960	063636 029609	
AHSPT012	063636 110123	
AHSPT026	063636 000264	
CL-41	063636 001414	
AHSPT028	063636 000288	
AHSPT029	063636 000295	
CL-241	063636 002411	

### Storage Information Labels

### Communication Labels

Item #	UPC	Label
PP-1	663104 022219	
PP-2	663104 022226	
LPH-163	063636 001636	
1-56G	663104 001566	
1-584	663104 005847	
CL-724	063636 007249	
1-343	663104 003430	
2286	663104 022868	
P-90	063636 090005	
LPH-36	063636 010362	
LPH-79	063636 000790	
AHSPT011	063636 110116	
AHSPT042	063636 000424	

Item #	UPC Code	Label
1-38G	663104 001382	
1-53G	663104 001535	
1-54G	663104 001542	
1-55G	663104 001559	
1-56G	663104 001566	
17729	663104 177292	
LPH-171	063636 001711	
LPH-197	063636 001971	
AHSPT054	063636 000547	
17729	663104 177292	
LPH-230	063636 102302	

### Dosing Information Labels

## Dosing Information Labels

Item #	UPC	
LPH-231	063636 002312	Pharmacy Added:
5-376	663104 053763	NOTE: MEDICATION BROKEN IN HALF
2285	663104 022853	NOTE: MEDICATION BROKEN IN HALF
2054	663104 020545	SINGLE USE ONLY
1-356	663104 003562	STRENGTH OF TAB/CAP DIFFERENT FROM THAT OF DOSE ORDERED. GIVE APPROPRIATE AMOUNT.
2306	663104 723064	USE FIRST
LPH-172	063636 001728	SHORT DATED USE FIRST
LPH-75	063636 000752	USE FIRST
2307	063636 023072	USE LAST
17838	063636 178383	WARFARIN
17864	063636 178642	MUST BE DILUTED
1-301	663104 003010	A GENERIC EQUIVALENT DRUG has been dispensed of the same QUALITY and at a LOWER PRICE
1-305	663104 003058	GENERIC SUBSTITUTION MADE
1-306	663104 003065	A GENERIC DRUG HAS BEEN DISPENSED AT A LOWER PRICE
1-368	663104 003683	GENERIC EQUIVALENT DISPENSED AS REQUIRED BY INSURANCE CARRIER
P-11	663104 008114	AN INTERCHANGEABLE PHARMACEUTICAL PRODUCT HAS BEEN SUPPLIED. Colour, size or shape may appear different.
1-61G	663104 001610	THIS IS THE SAME MEDICATION YOU HAVE BEEN GETTING. COLOR, SIZE OR SHAPE MAY APPEAR DIFFERENT.
LPH-97	063636 000974	MEDICATION IN VIAL
LPH-153	063636 001537	ATTENTION: MEDICATION IN COMPANION STRIP, VIAL, BOTTLE OR CARD
AHSPT033	063636 110338	DOSE IN 2 PORTIONS
LPH-164	063636 001643	Please half tablets. Medication Stable for 48h only when halved.
LPH-187	063636 001872	MEDICATION DISCONTINUED REMOVE FROM PACKAGE
LPH-190	063636 001902	LONG ACTING NARCOTIC
AHSPT01	063636 111113	LONG ACTING
AHSPT03	063636 111335	SHORT ACTING
AHSPT014	063636 110147	SINGLE-DOSE VIAL
AHSPT015	063636 110154	START HERE

## Nursing Labels

Item #	UPC	
TP1	663104 000439	NURSING
TP2	663104 000446	MEDICINE
TP3	663104 000453	RECREATION
TP20	663104 020208	ACTIVATION
TP24	663104 004246	REHABILITATION
TP6	663104 000477	PASTORAL CARE
LPH-18	063636 000189	Altered by Nursing Check MAR
CL-541	063636 005412	REFER TO PATIENT'S eMAR FOR DOSE
LPH-119	063636 001193	DIRECTIONS CHANGED REFER TO MAR SHEET
LPH-124	063636 001247	DIRECTIONS CHANGED REFER TO MAR
LPH-130	063636 901301	CHECK MAR
LPH-29	063636 029005	CHECK PULSE AND RECORD
LPH-11	063636 111007	REMOVE DISCONTINUED MEDICATIONS REFER TO MAR SHEET
LPH-30	063636 003012	TARGETED
LPH-32	063636 003203	PATIENT SPECIFIC
LPH-69	063636 010690	PLEASE RECONCILE THIS PATIENT'S HOME MEDICATION LIST
LPH-166	063636 001667	DAY PROGRAM
LPH-181	063636 001810	REASSESS
AHSPT044	063636 000448	One Pen, One Patient Prime Every Time

## Refill Information Labels

Item #	UPC	
1-13G	663104 001139	THIS PRESCRIPTION CAN ONLY BE REFILLED BY AUTHORITY OF YOUR PHYSICIAN
1-20G	663104 001209	THIS PRESCRIPTION CAN BE REFILLED. PLEASE BRING CONTAINER TO US WHEN REORDERING.
1-21G	663104 001214	THIS PRESCRIPTION MAY BE REFILLED
1-22G	663104 001221	THIS PRESCRIPTION MAY BE REFILLED TIMES
1-27G	663104 001276	THIS PRESCRIPTION CANNOT BE REFILLED
1-30G	663104 001306	YOUR PRESCRIPTION HAS BEEN GIVEN A NEW NUMBER. PLEASE USE THIS WHEN REORDERING.
1-41G	663104 001412	This Prescription CANNOT be Refilled Without A Written Duplicate From Your Physician
1-50G	663104 001504	AVOID WAITING for your prescription refills by calling the day before you come in. Thank You
2215	063636 221508	WE OWE YOU
1-89G	663104 001894	YOU MUST see a physician before this prescription can be refilled
1-92G	663104 001924	PHYSICIANS AUTHORIZATION REQUIRED FOR REFILL PLEASE CALL 24 HOURS IN ADVANCE
1-97G	663104 001979	REFILLS EXPIRE ONE YEAR FROM ORIGINAL FILL DATE
1-312	663104 003126	May Be Refilled 3 Times
1-314	663104 003140	May Be Refilled 5 Times
1-65G	663104 001658	THIS ITEM WAS SPECIALLY ORDERED FOR YOU. PLEASE CONTACT US A DAY AHEAD TO REORDER.
1-77G	663104 001771	THIS IS THE LAST REFILL FOR THIS PRESCRIPTION please contact your physician
1-44G	663104 001443	PLEASE CONTACT YOUR PHYSICIAN BEFORE ORDERING REFILLS
CL-534	063636 005344	ALLOW 2 BUSINESS DAYS FOR REFILLS
Item #	UPC	
2410	663104 124104	SALINE FLUSH
LPH-182	063636 001827	SALINE
17523	063636 175236	FOR CENTRAL LINE ADMINISTRATION ONLY
17573	663104 175731	HEPARIN FLUSH
17574	663104 175748	SALINE FLUSH
LPH-15	063636 015008	High Alert Double Check MUST DILUTE before IV use
AHSPT027	063636 000271	DO NOT USE FOR PERIPHERAL IV
LPH-211	063636 002114	FOR PCA Infusion only

## IV Administration Labels

## French Labels

Item #	UPC	
FG-10	663104 007179	BIEN AGITER
FG-11	663104 007186	POUR USAGE EXTERNE SEULEMENT
FG-13	663104 007209	Cette Prescription ne peut être répétée sans l'autorisation du médecin
FG-15	663104 007223	Garder au réfrigérateur NE PAS CONGELER.
FG-22	663104 007285	Cette ordonnance PEUT ÊTRE RENOUELLÉE FOIS
FG-27	663104 007322	CETTE PRESCRIPTION N'EST PAS RENOUELLABLE
FG-28	663104 007339	NE PAS EMPLOYER APRES Date
FG-32	063636 320027	Les Opioides peuvent causer une DÉPENDANCE, une TOXICOMANIE, et une SURDOSE
FG-40	663104 007414	BIEN AGITER ET CONSERVER AU RÉFRIGÉRATEUR
FG-47	663104 007469	NE PAS PRENDRE AVEC DU LAIT, DES JUS, OU DES ANTIACIDES PRENDRE SEULEMENT AVEC DE L'EAU
FG-49	663104 007476	AGITEZ BIEN AVANT USAGE
FG-50	663104 028044	ÉVITER D'ATTENDRE pour un renouvellement d'ordonnance. Téléphoner la veille. Merci
FG-61	663104 007599	Ce médicament est le même que d'habitude. La couleur, la grosseur ou la forme peuvent varier.
FG-77	663104 007704	CECI EST VOTRE DERNIÈRE RÉPÉTITION POUR CETTE PRESCRIPTION S.V.P. CONSULTEZ VOTRE MÉDECIN
F-324	063636 032401	NE PAS RÉFRIGÉRER
FW-3	663104 007032	Prendre à jeun, 1 heure avant ou 2 à 3 heures après un repas.
FX-1	663104 007018	Peut entraîner la SOMNOLENCE. Alcool peut accentuer cet effet. Être prudent en conduisant un véhicule motorisé ou aux commandes de machines dangereuses.
FX-10	663104 007100	PRENDRE AVEC NOURRITURE
FX-11	663104 007117	ÉVITER TOUTE EXPOSITION DIRECTE PROLONGÉE AUX RAYONS DE SOLEIL NATURELS OU ARTIFICIELS LORS DE LA PRISE DE CE MÉDICAMENT.
FX-12	663104 007124	RÉFRIGÉRER-BIEN AGITER DÉTRUIRE APRÈS
FX-2	663104 007025	IMPORTANT A moins d'avis contraire du médecin, CE MÉDICAMENT doit être pris au complet.
FX-4	663104 007049	Après la prise de ce médicament, attendre une heure avant de consommer des produits laitiers, des antiacides ou de fer
FX-5	663104 007056	BOIRE beaucoup D'EAU AVEC CE MÉDICAMENT
FX-8	663104 007087	NE PAS BOIRE D'ALCOOL PENDANT QUE VOUS PRENEZ CE MÉDICAMENT
LPH-101	663104 101013	1 RENOUELLLEMENT RESTANT À CETTE PRESCRIPTION. SVP VOIR VOTRE MÉDECIN.
LPH-108	063636 010805	CHANGEMENT DE DIRECTIONS, RÉFÉRER AU DOSSIER
LPH-149	063636 001490	Garder hors de la portée des enfants

### French Labels

Item #	UPC	Label
LPH-205	063636 020507	<b>À CONGELER</b>
FP-2	063036 000028	La méthadone peut sérieusement nuire à toute personne autre que le patient visé. Elle ne peut pas être utilisée par toute autre personne que le patient visé. PEUT ÊTRE FATALE À L'ENFANT OU À L'ADULTE.
FP-8353	063636 083533	<b>ALERTE ÉLEVÉE</b>
CL-5	063636 010058	SVP allouer 48h pour tout renouvellement.
LPH-191	063636 001919	<b>Héparine/Saline</b>

### Anesthesia & Critical Care Labels

Item #	UPC	Label
B1	663104 002013	<b>Nitroglycerine</b> mg/mL
B25	663104 002259	<b>Fentanyl</b> mcg/mL
B3	663104 002037	<b>Droperidol</b> mg/mL
B26	663104 002266	<b>Meperidine</b> mg/mL
B39	663104 002396	<b>VERSED®/Midazolam</b> mg/mL
B27	663104 002273	<b>Morphine</b> mg/mL
B2	663104 002020	<b>Diazepam</b> mg/mL
B36	663104 002365	<b>Sufentanil</b> mcg/mL
B4	663104 002044	<b>Lidocaïne</b> mg/mL
B46	663104 002464	<b>Remifentanil</b> mcg/mL
B28	663104 002280	<b>Naloxone</b> mg/mL
B14	663104 002143	<b>Mivacurium</b> mg/mL
B16	663104 002167	<b>Atracurium</b> mg/mL
B40	663104 002402	<b>Oxytocin</b> units/mL
B17	663104 002174	<b>Rocuronium</b> mg/mL
B5	663104 002051	<b>Atropine</b> mg/mL
B18	663104 002181	<b>Pancuronium</b> mg/mL

### Anesthesia & Critical Care Labels

Item #	UPC	Label
B6	663104 002068	<b>Glycopyrrolate</b> mg/mL
B19	663104 002198	<b>Succinylcholine</b> mg/mL
B12	663104 002129	<b>Hydromorphone</b> mg/mL
B7	663104 002075	<b>Heparin</b> units/mL
B35	663104 002358	<b>Vecuronium</b> mg/mL
B8	663104 002082	<b>Thiopental</b> mg/mL
B45	663104 002457	<b>Cisatracurium</b> mg/mL
B41	663104 002419	<b>Ketamine</b> mg/mL
B31	663104 002310	<b>ePHEDrine</b> mg/mL
B9	663104 002099	<b>Propranolol</b> mg/mL
B32	663104 002327	<b>Phenylephrine</b> mg/mL
B21	663104 002211	<b>Edrophonium</b> mg/mL
B44	663104 002440	<b>EPInephrine</b> mg/mL
B22	663104 002228	<b>Neostigmine</b> mg/mL
LPH-189	063636 001896	<b>Ropivacaine</b> mg/mL
LPH-93	063636 000936	<b>Ropivacaine</b> mg/mL
LPH-94	063636 000943	<b>ROPIVACAINE</b>
CL-1474	063636 014742	<b>HYDROMORPHONE</b>

### Generic Drug

Item #	UPC	Label
LPH-25	063636 025007	<b>CALCIUM CHLORIDE</b> mg/ml
LPH-34	063636 034009	<b>ONDANESTRON</b>
LPH-66	063636 006600	<b>PROTAMINE</b> mg/ml
LPH-74	063636 000745	<b>MACHINE HEPARIN</b> units/ml
LPH-118	063636 011185	<b>norepinephrine</b>
LPH-87	063636 000875	<b>Bupivacaine</b> mg/mL
LPH-92	063636 000929	<b>SYNTOCINON</b>
2154	063636 021542	<b>HEPARIN</b>
LPH-136	063636 001360	<b>Diphenhydramine/Benadryl</b> mg mL
LPH-160	063636 001605	<b>Dimenhydrate/Gravol</b> mg mL
LPH-183	063636 001834	<b>Furosemide/Lasix</b> mg mL
LPH-201	063636 020101	<b>ONDANSETRON</b>
LPH-203	063636 020309	<b>Ketorolac/Toradol</b> mg/mL
LPH-206	063636 020606	<b>Potassium Chloride (KCl)</b>
LPH-219	063636 002190	<b>FLOMAX</b>
LPH-220	063636 002206	<b>COUMADIN</b>
LPH-222	063636 002220	<b>MANNITOL</b>
17838	063636 178383	<b>WARFARIN</b>
2311	663104 023117	<b>FENTANYL</b>
17790	063636 177904	<b>FENTANYL</b> mcg/mL Date _____ Time _____ Int _____
17944	663104 179449	<b>PROPOFOL</b>
2868	063636 286811	<b>OXYTOCIN</b>
17792	063636 177928	<b>VERSED</b> mg/mL Date _____ Time _____ Int _____
CL-1236	063636 012366	<b>ANTIBIOTIC</b>

### Error Prevention Labels

Item #	UPC	Label
LPH-100	063636 010096	<b>STOP! HYDRomorphone is NOT MORphine</b>
AHSPT038	063636 010386	<b>CUSTOM Concentration Independent Double-Check Required</b>
18253	063636 182533	<b>LOOK ALIKE SOUND ALIKE</b>
2308	063636 023089	<b>LOOK ALIKE SOUNDS ALIKE</b>
AHSPTOBAX	063636 111199	<b>HIGH ALERT DRUG</b>
8353	063636 683535	<b>HIGH ALERT DOUBLE CHECK</b>
8354	063636 683542	<b>HIGH ALERT DOUBLE CHECK</b>
8352	063636 683528	<b>HIGH ALERT</b>
8350	063636 683504	<b>HIGH ALERT</b>
8351	063636 683511	<b>HIGH ALERT</b>
2089	063636 820893	<b>STOP! POTENTIAL ERROR DOUBLE CHECK</b>
2090	063636 820909	<b>HIGH ALERT INSULINS</b>
2155	063636 021559	<b>FOR EPIDURAL USE ONLY</b>
2968	063636 029685	<b>HIGH ALERT</b>
17520	063636 175207	<b>HAZARDOUS DRUGS</b>
18251	063636 182519	<b>HIGH ALERT</b>
FP-8353	063636 083533	<b>ALERTE ÉLEVÉE</b>

## Hospital Information Labels



Cytotoxic  
Cytotoxique

PCT-1  
2 1/4 x 3 1/4"  
500/Roll  
063636 163204



Cytotoxic  
Cytotoxique

PCT-3  
1 x 3/4"  
1000/Roll  
663104 177324



MEDICATION ADDED  
DRUG ADDITIVE AMOUNT

ADDED BY \_\_\_\_\_  
DATE \_\_\_\_\_ TIME \_\_\_\_\_  
PATIENT \_\_\_\_\_  
ROOM NO. \_\_\_\_\_  
START TIME \_\_\_\_\_  
START DATE \_\_\_\_\_  
FLOW RATE \_\_\_\_\_  
BASE SOL'N \_\_\_\_\_

21-2  
2 x 3"  
500/Roll (2 Rolls)  
663104 121202

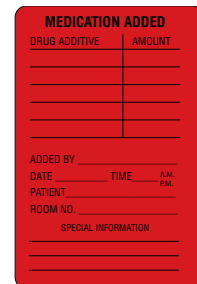

MEDICATION ADDED  
DRUG ADDITIVE AMOUNT

ADDED BY \_\_\_\_\_  
DATE \_\_\_\_\_ TIME \_\_\_\_\_  
PATIENT \_\_\_\_\_  
ROOM NO. \_\_\_\_\_  
SPECIAL INFORMATION \_\_\_\_\_

MAR1  
2 x 3"  
1000/Roll  
663104 111005

**CHEMOTHERAPY  
DISPOSE OF PROPERLY**

CC2  
6 x 1 1/16"  
500/Roll  
663104 033208

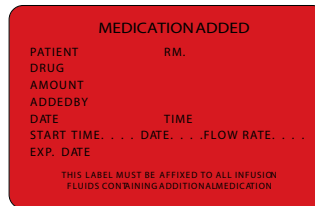

MAR3  
2 3/4 x 1 3/4"  
1000/Roll  
663104 333001

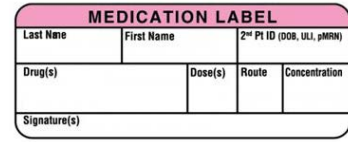

MAR8  
2 1/2 x 1"  
1000/Roll  
063636 000080

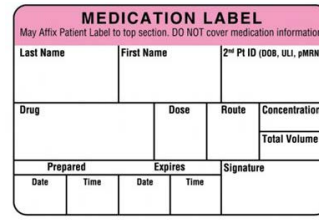

MAR9  
3 x 2"  
1000/Roll  
063636 900007

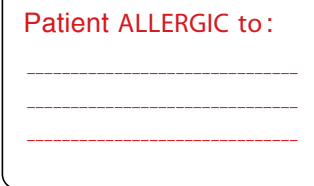

23-1  
2 3/4 x 1 3/4"  
1000/Roll  
663104 023100

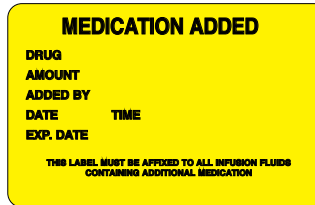

23-2  
2 3/4 x 1 3/4"  
1000/Roll  
663104 023209

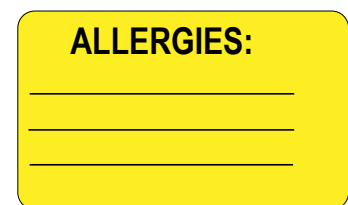

17614  
2 1/2 x 1 1/2"  
500/Roll (2 Rolls)  
063636 176143

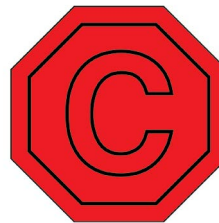

PCT-8  
3/4" Hexagon  
1000/Roll  
063636 000813

## Veterinary Labels



VET26  
063636 100261



VET13  
063636 200138



VET47  
063636 100476



VET27  
063636 100278

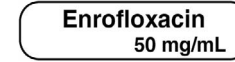

VET31  
063636 200312



VET15  
063636 100155



VET33  
063636 100339



VET44  
063636 100445



VET36  
063636 100360



VET37  
063636 100377



VET52  
063636 200527



VET23  
063636 100230



VET48  
063636 100483



VET40  
063636 100407



VET11  
063636 100117

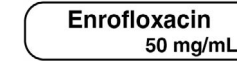

VET51  
063636 300517



P-18  
663104 180001



VET34  
063636 100247



VET12  
063636 400125



VET43  
063636 100438

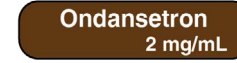

VET49  
063636 100490



VET16  
063636 100162



VET30  
063636 100308



VET20  
063636 100209



VET42  
063636 100421



VET38  
063636 100384



VET28  
063636 100285



VET21  
063636 100216



VET24  
063636 100247



VET46  
063636 100469



VET10  
063636 100100

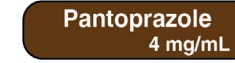

VET50  
063636 300500



VET17  
063636 100179



VET25  
063636 100254



VET35  
063636 100353



VET45  
063636 100452



VET39  
063636 100391



VET32  
063636 500320



VET14  
063636 200145



VET19  
063636 100193

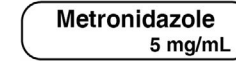

VET29  
063636 100292



VET18  
063636 100186



VET22  
063636 100223



VET41  
063636 100414

### Blank Labels

Item #	Description	UPC
A10	White Blank	663104 001009
A11	Red Blank	663104 011152
A12	Green Blank	663104 001207
A13	Orange Blank	663104 011305
2204	Pink Blank	663104 022042
2211	Yellow Blank	663104 022110
2214	Blue Blank	663104 022141
2546	White Circle	663104 025463
2548	Orange Circle	663104 025487
2550	Red Circle	663104 022509
2551	Flo Orange Circle	063636 025519
2555	Blue Circle	663104 025555
2558	Pink Circle	663104 022585

### Weekday Auxiliary Labels

- Colour-coded labels measure 7/8 x 3/8"
- Packages include 2 rolls of 500 labels
- Weekday Set (# P-80) includes 2 rolls of 500 for each day

Item #	Weekday	UPC
P-80	Weekday Set	063636 808082
P-70	Monday, "MON."	063636 123123
P-71	Tuesday, "TUES."	063636 124410
P-72	Wednesday, "WED."	063636 125417
P-73	Thursday, "THUR."	063636 126742
P-74	Friday, "FRI."	063636 127473
P-75	Saturday, "SAT."	063636 128876
P-76	Sunday, "SUN."	063636 129880

### Weekday Auxiliary Labels



- Labels are 3/4" circles and are colour-coded
- 500 labels per package

Item #	Description	Colour	UPC
17916	MON	Yellow	063636179168
17917	TUE	Red	063636179175
17918	WED	Sky Blue	063636179182
17919	THU	Green	063636179199
17920	FRI	Orange	063636179205
17921	SAT	Fuchsia	063636179212
17922	SUN	Royal Blue	063636179229

### Months Label Package



- Labels are 3/4" circles and are colour-coded
- Item # P-100 (English) and P-101 (French) includes 12 sheets of labels, 108 labels per sheet- 1 sheet for each month of the year
- Each are available for individual purchase, 108 labels/sheet (Item # P-41- P-58)

Item #	Description	UPC
P-100	Months of the year label package (English)	063636868000
P-101	Months of the year label package (French)	063636868437
P-41	JAN (English/French)	063636864101
P-42	FEB (English)	063636868826
P-53	FEV (French)	063636868420
P-43	MAR (English/French)	063636868833
P-44	APR (English)	063636868840
P-54	AVR (French)	063636868444
P-45	MAY (English)	063636868857
P-55	MAI (French)	063636868512
P-46	JUN (English)	063636868864
P-56	JUIN (French)	063636868505
P-47	JUL (English)	063636868871
P-57	JUIL (French)	063636868536
P-48	AUG (English)	063636866884
P-58	AOU (French)	063636868543
P-49	SEP (English/French)	063636 868895
P-50	OCT (English/French)	063636868888
P-51	NOV (English/French)	063636868406
P-52	DEC (English/French)	063636 868413

### Label Adhesive Remover, 32 oz.

- Easily removes the sticky residue that builds up on surfaces that have labels and tape applied and removed on a regular basis
- This citrus based adhesive remover contains no hazardous solvents or toxic fumes
- Bio-degradable and non-flammable
- Comes in a clear, unbreakable plastic squeeze bottle



Item #	UPC
7065-10	063636706517

### Label Dispensers

- Rugged construction and high quality design ensure years of trouble free use
- Superior design permits one hand label dispensing
- Dispensers can be quickly loaded and easily cleaned
- Holds any of the PharmaSystems® standard size warning labels, shown on previous pages in this section
- Additional, pre-loaded options below



Item #	Description	UPC
BK-10	Label Dispenser for 10 Rolls	063636000103
BK-20	Label Dispenser for 20 Rolls	063636000202
BK-30	Label Dispenser for 30 Rolls	063636000301

### 17/20, Warning Label System

- 17 rolls of 500 auxiliary labels preloaded into a 20 roll label dispenser (includes BK-20 model)
- Select from English or French sets



Item #	Description	UPC Code
BK-40	A English Warning Label System	063636404048
FW-1720	B French Warning Label System	063636172022

### 20/30, Warning Label System

- 20 rolls of 500 auxiliary labels preloaded into a 30 roll label dispenser (includes BK-30 model)
- Select from English or French sets



Item #	Description	UPC Code
BK-50	A English Warning Label System	063636494940
FW-1730	B French Warning Label System	063636173036

BK-40	FW-1720
P-1	FG-61
1X	FW-15
2X	F-669
3W	FX-1
4X	FX-10
5X	FX-11
6X	FX-12
P-12	FX-2
8X	FX-5
1-10G	FX-4
10X	FG-27
11X	FX-8
12X	FG-10
1-15G	F-690
15W	FG-77
16W	FG-13
1-11G	FG-15

BK-50	FW-1730
1X	FG-15
2X	FW-15
3W	FW-3
4X	FX-1
5X	FX-10
8X	FX-11
10X	FX-12
11X	FX-2
15W	FX-4
1-10G	FX-5
1-11G	FG-61
1-49G	FX-8
1-70G	FG-27
1-77G	FG-10
1-332	F-690
1-360	FG-77
1-669	FG-28
1-690	FG-13
P-1	FG-49
P-12	F-324

### Stainless Steel Label Dispensers

- Labels in blister packed rolls fit without dividers, but dividers can be inserted to accommodate labels on plain rolls
- The front label guides accommodate up to 3/4" W labels

Item #	Description	UPC
2504-01	10 Roll Label Dispenser 7 1/8"W x 4 1/8"H x 4 1/4"D	063636725044
2506-01	30 Roll Label Dispenser 19 5/16"W x 4 1/8"H x 4"D	063636725068

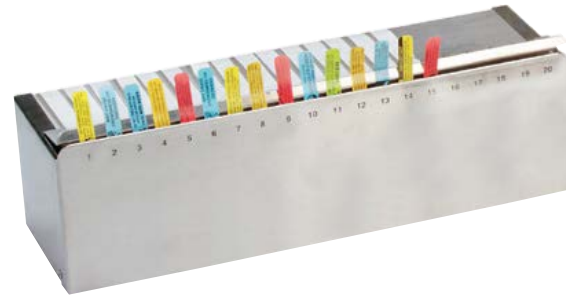

### Stack & Connect Label Dispensers

- Clear plastic dispensers interlock to stack and connect – create your own customized label dispenser

#### 10 roll dispenser (item # 12721):

- Includes 9 removable dividers, when used accommodate labels measuring 5/8" wide
- Accommodates blister-packed labels as well as labels on a roll
- Accommodates 500 and 1000 roll labels/packs

#### 20 roll dispenser (item # 12998):

- Does not include dividers
- Accommodates blister-packed labels and labels on a roll
- Only 500 roll labels/packs will work

#### Mounting Brackets:

- Allows dispensers to be mounted to counters or cabinets
- Pre-drilled holes in white plastic brackets
- Mounting hardware and two-sided tape included

Item #	Description (W" x H" x D")	UPC
12721	A 10 Roll Label Dispenser (8 1/4" x 5" x 4 3/4")	063636727215
12998	B 20 Roll Label Dispenser (15 3/4" x 4 3/8" x 4 3/4")	063636729981
17027	C Mounting Bracket for #12721 10 Roll Dispenser	063636170271
17028	D Mounting Bracket for #12998 20 Roll Dispenser	063636170288

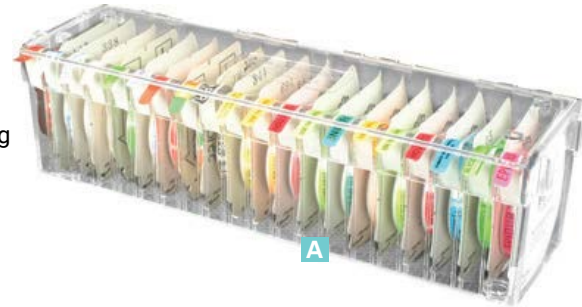

### Patient Privacy Label

- Quick and affordable way to protect sensitive patient information and meet HIPAA standards
- Wrap over labels on prescription vials, punch cards, syringes and IV bags. Patient information is then secure
- Tamper-resistant slits cause the label to self-destruct upon attempted removal
- No need to scrape patient labels or invest in expensive shredding or incineration equipment or services
- Opaque blue label
- Use in pharmacies, hospitals, long and short term care facilities, mental health facilities, clinics and physicians offices
- Dimensions: 3"W x 1-7/8"H (76mm x 48mm)
- Two rolls of 500; 1,000 labels total

Item #	UPC
7038	063636070380



### Labeling Tape

- Size: 1/2" x 500"
- Core Size: 1"
- Adhesive: Removable
- Unit of Measure: Roll
- Qty per UOM: 500
- Individually packaged



<b>ATRAcurium</b> _____ mg/mL Date _____ Time _____ : _____ Int. _____ TP25	<b>Atropine</b> _____ mg/mL Date _____ Time _____ : _____ Int. _____ TP17	<b>Bupivacaine</b> _____ mg/mL Date _____ Time _____ : _____ Int. _____ TP14	<b>Cefazolin</b> _____ mg/mL Date _____ Time _____ : _____ Int. _____ TP19
<b>Dopamine</b> _____ mg/mL Date _____ Time _____ : _____ Int. _____ TP07	<b>Ephedrine</b> _____ mg/mL Date _____ Time _____ : _____ Int. _____ TP08	<b>Epinephrine</b> _____ mg/mL TP10	<b>Fentanyl</b> _____ mcg/mL Date _____ Time _____ : _____ Int. _____ TP03
<b>Glycopyrrolate</b> _____ mg/mL Date _____ Time _____ : _____ Int. _____ TP18	<b>Heparin</b> _____ % Date _____ Time _____ : _____ Int. _____ TP16	<b>Hydromorphone</b> _____ mg/mL Date _____ Time _____ : _____ Int. _____ TP31	<b>Ketamine</b> _____ mg/mL Date _____ Time _____ : _____ Int. _____ TP23
<b>Lidocaine</b> _____ mg/mL Date _____ Time _____ : _____ Int. _____ TP13	<b>Midazolam</b> _____ mg/mL Date _____ Time _____ : _____ Int. _____ TP24	<b>Morphine</b> _____ mg/mL Date _____ Time _____ : _____ Int. _____ TP04	<b>Neostigmine</b> _____ mg/mL Date _____ Time _____ : _____ Int. _____ TP29
<b>Nitroglycerin</b> _____ mg/mL Date _____ Time _____ : _____ Int. _____ TP11	<b>Norepinephrine</b> _____ mg/mL Date _____ Time _____ : _____ Int. _____ TP06	<b>Oxytocin</b> _____ mg/mL Date _____ Time _____ : _____ Int. _____ TP20	<b>PANcuronium</b> _____ mg/mL Date _____ Time _____ : _____ Int. _____ TP27
<b>Phenylephrine</b> _____ mg/mL Date _____ Time _____ : _____ Int. _____ TP09	<b>Propofol</b> _____ mg/mL Date _____ Time _____ : _____ Int. _____ TP30	<b>Protamine Sulfate</b> _____ % Date _____ Time _____ : _____ Int. _____ TP21	<b>Remifentanyl</b> _____ mcg/mL Date _____ Time _____ : _____ Int. _____ TP02
<b>ROcuronium</b> _____ mg/mL Date _____ Time _____ : _____ Int. _____ TP26	<b>Ropivacaine</b> _____ mg/mL Date _____ Time _____ : _____ Int. _____ TP15	<b>Succinylcholine</b> _____ mg/mL Date _____ Time _____ : _____ Int. _____ TP28	<b>Sufentanil</b> _____ mg/mL Date _____ Time _____ : _____ Int. _____ TP05

**Labeling Tape**

- Size: 1 3/4" x 1/2"
- Qty: 6 rolls; 500" or approximately 285 labels per roll
- Rolls are packaged in clear, stackable containers with click-to-close design
- Perforations improve ease of use and help eliminate waste

**2578**

- Size: 1 3/4" x 1"
- 3 rolls; 500" or approximately 285 labels per roll



2540	2578	2531	2526
2523	2528	2570	2560
2514	2515	2517	2563
2527	2525	2519	2565
2542	2561	2510	2562
2571	2518	2513	2529
2535	2530	2511	2538
2534	2567	2512	2544
2543			

# CUSTOM LABEL ORDER FORM

**1. SELECT LABEL SIZE & QUANTITY**

Label Item #: \_\_\_\_\_ Quantity: \_\_\_\_\_ box(es)

**2. SELECT LABEL & TEXT COLOUR**

**Label Colour**

- Red
- Blue
- Yellow
- Black
- White
- Green
- Orange
- Other

Specify: \_\_\_\_\_

- Fluorescent Red\*
- Fluorescent Orange\*
- Fluorescent Yellow\*
- Fluorescent Green\*
- Fluorescent Pink\*

\*Black text only

**Text Colour**

- Red
- Blue
- Yellow
- Black
- White
- Green
- Orange
- Other

Specify: \_\_\_\_\_

**3. LABEL INFORMATION (PLEASE PRINT CLEARLY)**

**3. INCLUDE A SYMBOL (OPTIONAL)**

To include a company logo, please supply the vector file. (Only vector files will be accepted)



Symbol #: \_\_\_\_\_

Email or fax completed order form to [orders@pharmasystems.com](mailto:orders@pharmasystems.com) | 1.888.475.7155

<b>Pharmacy:</b> _____	<b>Name:</b> _____
<b>Address:</b> _____	<b>Phone:</b> _____
<b>City:</b> _____	<b>Fax:</b> _____
<b>Province:</b> _____ <b>Postal Code:</b> _____	<b>Email:</b> _____
<b>Date:</b> _____	<b>Wholesaler:</b> _____ <b>Account No.:</b> _____

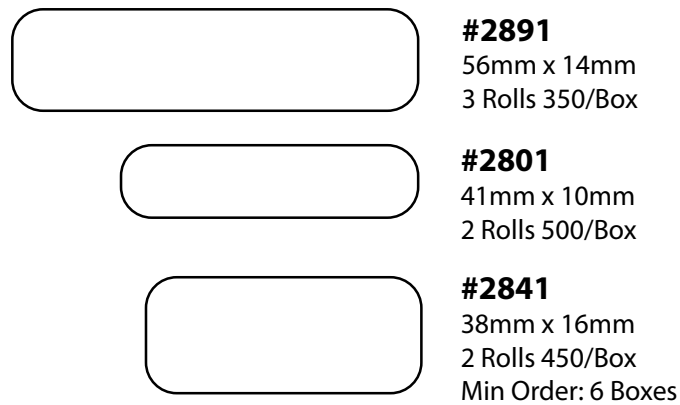

**#2891**  
56mm x 14mm  
3 Rolls 350/Box

**#2801**  
41mm x 10mm  
2 Rolls 500/Box

**#2841**  
38mm x 16mm  
2 Rolls 450/Box  
Min Order: 6 Boxes

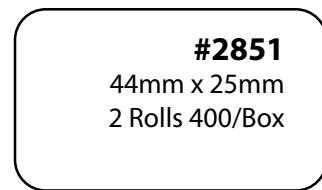

**#2851**  
44mm x 25mm  
2 Rolls 400/Box

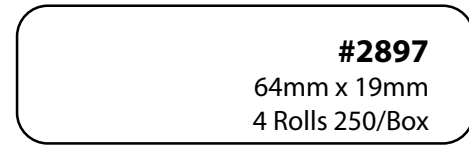

**#2897**  
64mm x 19mm  
4 Rolls 250/Box

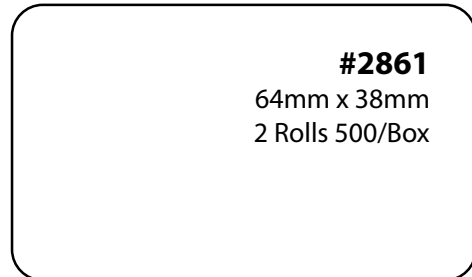

**#2861**  
64mm x 38mm  
2 Rolls 500/Box

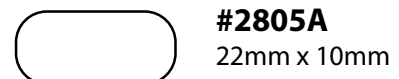

**#2805A**  
22mm x 10mm



**#2702**  
16mm x 16mm  
1 Roll 1000/Box

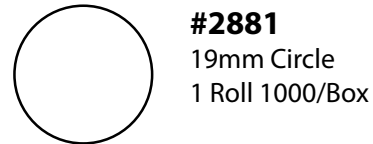

**#2881**  
19mm Circle  
1 Roll 1000/Box

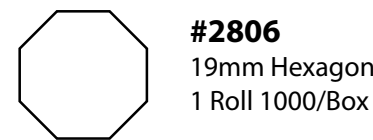

**#2806**  
19mm Hexagon  
1 Roll 1000/Box

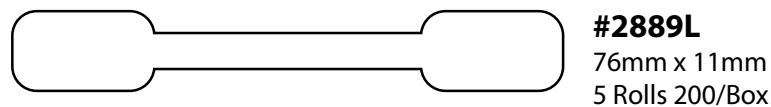

**#2889L**  
76mm x 11mm  
5 Rolls 200/Box



**#2871**  
92mm x 76mm  
4 Rolls 250/Box



**#2821**  
89mm x 22mm  
5 Rolls 200/Box

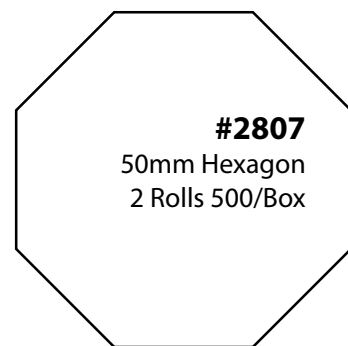

**#2807**  
50mm Hexagon  
2 Rolls 500/Box

### ChemoSafety™ Sharps Disposal Containers

- Designed for sharps disposal as well as other types of chemotherapy waste, including IV bags, tubing, and syringes
- Container features snap-on lid with locking rotor that locks for final disposal
- Sealing gasket guards against spills - a pad on the bottom of the container absorbs excess liquid
- Labelled "Chemotherapy Waste"
- Nest unused containers inside each other for stacking
- Made of polypropylene plastic - dispose by incineration

Item #	Capacity	Dimensions (W x H x D)	Qty	UPC
9605-10 <b>A</b>	2 gallon	10 <sup>1</sup> / <sub>8</sub> x 9 <sup>1</sup> / <sub>2</sub> x 6 <sup>3</sup> / <sub>4</sub> "	20	063636960520
9607-01 <b>B</b>	8 gallon	15 x 17 x 10 <sup>1</sup> / <sub>4</sub> "	1	063636960711
9607-10	8 gallon	15 x 17 x 10 <sup>1</sup> / <sub>4</sub> "	10	063636960728

### SharpStar™ Sharps Containers

- Minimize the potential for over-filling by stopping in the "full" position
- The "always-open" lid is ready for quick disposal
- Large opening easily accommodates 60 mL syringes
- Extended flap keeps hands away from the container when locking
- Tamper resistant opening
- Smart choice for USP 797 compliance
- Complete system (item # 9600-01) includes a wall enclosure with lock, large glove dispenser, a 5 qt. (4.73 liters) transparent red sharps container and an in-service sticker

Item #	Capacity	Dimensions (W x H x D)	Qty	UPC
9601-01 <b>C</b>	5 quart	10 <sup>3</sup> / <sub>8</sub> x 9 <sup>1</sup> / <sub>8</sub> x 3 <sup>3</sup> / <sub>4</sub> "	1	063636960117
9601-06	5 quart	10 <sup>3</sup> / <sub>8</sub> x 9 <sup>1</sup> / <sub>8</sub> x 3 <sup>3</sup> / <sub>4</sub> "	20	063636960124

### Biohazard Sharps Disposal Containers

- Labelled "biohazard"
- Nest unused containers inside each other for stacking
- Complies with OSHA regulations for handling sharps
- 0.95 L (Item # 9604-01 and 9604-10) has a clear hinged lid with a variety of openings in different sizes for disposal of needles, lancets, butterfly tubing, and small syringes
- Made of polypropylene plastic - dispose by incineration

Item #	Capacity	Dimensions (W x H x D)	Qty	UPC
9602-01 <b>D</b>	2 gallon	10 x 9 <sup>3</sup> / <sub>4</sub> x 6 <sup>7</sup> / <sub>8</sub> "	1	063636960216
9602-06	2 gallon	10 x 9 <sup>3</sup> / <sub>4</sub> x 6 <sup>7</sup> / <sub>8</sub> "	20	063636960223
9603-01 <b>E</b>	8 gallon	15 x 17 x 10 <sup>3</sup> / <sub>8</sub> "	1	063636960315
9603-04	8 gallon	15 x 17 x 10 <sup>3</sup> / <sub>8</sub> "	10	063636960322
9604-01	1 quart	3 <sup>3</sup> / <sub>4</sub> x 6 x 3 <sup>3</sup> / <sub>4</sub> "	1	063636960414
9604-10 <b>F</b>	1 quart	3 <sup>3</sup> / <sub>4</sub> x 6 x 3 <sup>3</sup> / <sub>4</sub> "	100	063636960421



### Leaktight Sharps Containers

- Material - Translucent polypropylene helps determine fill level to prevent overfilling.
- Closure - Snap-tight lid allows easy closure for final disposal. Protective iris flange prevents insertion of inappropriate non-medical waste.
- Special Feature - Used sharp drops into the puncture-resistant plastic container needlepoint first and eliminates all unnecessary repositioning and excessive handling.

Item #	Capacity (Litres)	Dimensions (W x H x D)	Qty	UPC
8219	2 quart	3 1/2 x 10 x 3 1/2"	1	063636821906



### Flip Top Sharps Container

- Flip top lid closes securely to prevent spilling or leaking; ideal for transport
- Red polypropylene plastic
- Includes an orange and black biohazard sticker on the front of the container
- Autoclavable and can be incinerated - should be disposed of in accordance with local guidelines
- Smart choice for USP 797 compliance

Item #	Capacity	Dimensions (W x H x D)	Qty	UPC
9083	1 quart	Overall: 4 1/2 x 8 3/4 x 2 1/2, Fill Opening: 1 1/4 x 1 3/4	20	063636790837



Container holds approximately 30 of 3cc syringes, as well as other sizes and quantities

### Disposable Ampule Breaker

- Ampules can be safely opened by snapping the top of the ampule breaker to the side; thus breaking the top of the ampule off at the neck of the bottle - top of the ampule can then be discarded along with the ampule breaker
- Reduces the chance of finger cuts and cross contamination
- Disposable - eliminates need for sterilization
- Made out of polypropylene plastic

Item #	Dimensions	Qty	UPC
10262	2 x 1 1/4"	100	063636102623



### Needle Resheather

- Smart Design - Allows single-handed uncapping and recapping of needles. Securely grips needle, phlebotomy and intravenous catheter caps. Complies fully with OSHA standards.
- Use Anywhere - Base can be adhered to any clean smooth surface. Double-sided tape included.
- Easy to Clean - The top portion of the unit can be removed from the base and steam autoclaved, gas sterilized or disinfected by alcohol.
- Packaging - Sold individually
- Dimensions - 2 1/2"W x 3"H x 2 1/4"D

Item #	UPC
7375	063636773755



### Biohazard Leakproof Bags

- Closure - Adhesive closure with perforated tear zone.
- Special Feature - When closed correctly, bags are 100% leakproof bags and include a document pouch for important paperwork.

Item #	Thickness	Dimensions (W x H)	Qty	UPC
20426	2 mil	6 x 9"	100	063636774462



### Biohazard Bags

- Meets performance criteria established by OSHA
- Small (Item # 7446) has a fold over flap for closing
- Can be secured closed with a heavy duty security seal with prongs (see Item # 7836)

Item #	Thickness	Dimensions (W x H)	Qty	UPC
7446	A 1 1/2 mil	11 1/4 x 14 1/2"	50	063636774462
7445	B 4 mil	20 x 39 x 12 1/4"	25	063636774455

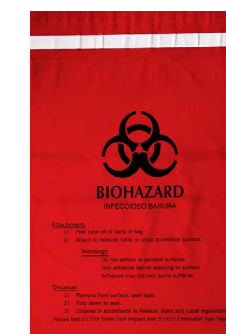

### Stick-On Biohazard Bag

- Includes an adhesive strip to stick to carts, cabinets, walls, etc.
- When bags are full, the top flap folds over and a second adhesive safely seals the bags

Item #	Thickness	Dimensions	Qty	UPC
9938	2 mil.	12" W x 14" H	100	063636779382



### Chemo Waste Bag

- Ideal for safe and economic disposal of chemo waste
- 20 gallon capacity

Item #	Thickness	Dimensions	Qty.	UPC
9617-10	4 mil	23 x 41 1/2" (opens to 31")	100	063636896171

### Chemobloc™ Safelock Drug Transport Bags

- Provides safe storage and transport of cytotoxic medications
- Reclosable with a single track zipper closure
- Write on area for patient information
- See more patient information bags on pages 39 & 43 in the Poly bags section

Item #	Thickness	Measures	Quantity	UPC
9490	4 mil	6" x 9"	100	063636794903
9491	4 mil	12" x 15"	250	063636794910



### Chemotherapy Transport and Batch Bags

- Heavy-duty clear reclosable bags provide a secure closure
- Latex free

Item #	Thickness	Size	Qty	UPC
CT6X9	<b>A</b> 4 mil	6 x 9"	100	063636140694
CT12X15	<b>B</b> 4 mil	12 x 15"	100	063636140250
CT6X9M	4 mil	6 x 9"	1000	063636146900
CT12X15M	4 mil	12 x 15"	1000	063636112158

### Chemotherapy Disposal bags

- Clear polyethylene bags with yellow blocks that contain bilingual (French and English) black print
- Chemotherapy disposal bags are used for transporting, storing, and disposing items used in chemotherapy prep or administration

Item #	Thickness	Size	Qty	UPC
9516	4 mil	9 x 12"	100	063636795160
9516M	4 mil	9 x 12"	1000	063636779511
9517	<b>C</b> 4 mil	12 x 15"	100	063636795177
9517M	4 mil	12 x 15"	1000	063636799571

### Chemo Prep Mats

- Provides an ideal surface for working under the hood or with a patient
- Surface of the three ply mat is firm and flat, with a penetrable mesh top layer, second layer is an absorbent gauze, and the bottom layer is non-permeable plastic
- Non-linting
- Smart choice for USP 797 compliance

Item #	Size	Qty	UPC
9621-01	17"W x 11"H	50	063636962104
9622-01	<b>D</b> 22"W x 16"H	50	063636962203

### ChemoSorb Pad

- Pads are impregnated with a solidifying agent that absorbs and transforms liquid to gel, making cleanup and disposal safe
- Lint and latex-free
- Disposable - for single use only

Item #	Size	Qty	UPC
12035	<b>E</b> 12 x 12"	20	063636812034



### Economy Emergency Spill Kit

- Perfect for small spills that need immediate attention
- Intended for one time use only

Item #	UPC
7464-01	063636746414

#### Included in the kit:

- 1 Bio-Wipe™ Bag
- 1 pair of latex free nitrile gloves
- 13.75 x 17.75" waffle-design paper towelette
- 1 antimicrobial hand wipe
- 2-ounce spray pump bottle of Cavicide® Cleaner
- Instruction sheet



### Basic Chemo Spill Kit

- Perfect for small spills that need immediate attention
- Packaged in a large zip-it bag for quick and easy access
- Intended for one time use only

Item #	UPC (063636)
9961-01	063636799618

#### Included in the kit:

- 1 fluid impervious gown
- 1 pair of chemo-nitrile gloves
- 1 impermeable mask with safety shield
- 1 Chemo Bio-Wipe™ Bag
- 3 absorbent towelettes
- 1 hard surface disinfectant wipe
- 1 chemo waste bag with twist tie
- 1 antimicrobial hand towelette
- 1 set of instructions for using the spill kit safely



### Beard Guards

- Ideal to cover beard, mustache, and sideburns
- Comfortable elastic strap loops behind ears
- Universal size
- Material - Polypropylene

Item #	Colour	Qty	UPC
12077-31	Blue	100	063636100315



### Plastic Shoe Covers

- Ideal for electronics processing, food processing, hospitals, laboratories, inspections and maintenance
- Elastic on top for easy usage and removal
- Textured bottom for skid resistance
- Flexible material for easy movement
- Made out of non-woven polypropylene

Item #	Size	Qty	UPC
S741	Universal	500 pairs	063636007416



### Disposable Isolation Gown

- Disposable gown meets AAMI PB70 Level II barrier protection
- Gown made of non-woven material with full back closure.
- Features: Flat belt, elastic cuffs and tie-on neck closure.

Item #	Size	Qty	UPC
GW100Y	L	10	063636201005
GW10Y	L	100	063636900106



### Personal Protection Gown

- Disposable gown has a stirrup cuff design to give the wearer added protection to the wrist area
- Back panel is open for cool comfort during long periods of wear
- Slip-on style neck loop (the shoulder panel at back is perforated for quick and easy removal)
- Made of embossed polyethylene, latex-free that passes ASTM F1670-95 standards

Item #	Size	Qty	UPC
20497	Universal	50	063636204976



### Nitrile Medical Examination Gloves

- Textured for extra grip and dexterity
- Excellent tensile strength and touch sensitivity
- Specify size when ordering

Item #	Sizes	Colour	Thickness	Qty	UPC
GNSMS	S	Blue	4 mil	100	063636998554
GNSMM	M	Blue	4 mil	100	063636998561
GNSML	L	Blue	4 mil	100	063636998592

### Glove Box Holders

- Conveniently stores multiple boxes in one location
- Store several sizes or different types of gloves in one holder
- Designed with key holes for mounting
- Can be wiped clean with soap and water or hospital sanitizer
- Stainless steel designs are smart choices for USP 797 compliance

Item #	Box Capacity	Description	Dimensions (W x H x D)	UPC
7468-01	A	White Enamel	10 <sup>7</sup> / <sub>8</sub> x 10 x 4"	063636746803
7466-01		Clear Plexiglas	10 <sup>7</sup> / <sub>8</sub> x 10 x 4"	063636746612
7474-01		Stainless Steel	16 <sup>1</sup> / <sub>8</sub> x 10 x 4"	063636747411
7461-01	B	White Enamel	16 <sup>1</sup> / <sub>8</sub> x 10 x 4"	063636746100
7467-01		Clear Plexiglas	16 <sup>1</sup> / <sub>8</sub> x 10 x 4"	063636746704
11948	C	Stainless Steel	22 <sup>1</sup> / <sub>4</sub> x 10 x 3 <sup>3</sup> / <sub>4</sub> "	063636119485
11949		White Enamel	22 <sup>1</sup> / <sub>4</sub> x 10 x 3 <sup>3</sup> / <sub>4</sub> "	063636119492
11950		Clear Plexiglas	22 <sup>1</sup> / <sub>4</sub> x 10 x 3 <sup>3</sup> / <sub>4</sub> "	063636119508

### Wire Glove Box Holders

- Stainless steel holder with tough white plastic coating
- Can accommodate a variety of glove box sizes
- Open design allows for carton copy to be readable

Item #	Box Capacity	Description	Dimensions (W x H x D)	UPC
8245	D	Horizontal	11 x 14 x 4	063636082451
7430-01	E	Horizontal	11.25 x 4.25 x 3.5	063636774301

### All Purpose Bulk Dispenser, Single Compartment

- Provides bulk storage for gloves, bouffant caps, shoe covers, hair nets, etc., to help reduce restocking and keep supplies stored in high-use areas
- Hinged lid provides dust protection and flips up for easy refill
- Dispensing window in the lower front allows quick access
- Place on counter or mount to most surfaces using the two key hole slots on the back panel

Item #	Material	Dimensions (W x H x D)	UPC
7426-01	F	PETG 12 <sup>1</sup> / <sub>4</sub> x 17 x 6"	063636774264

### Sanitizing Station

- Encourages infection prevention by providing protection supplies in waiting areas
- Clear PETG plastic - easily view inventory
- Hang using the keyhole slots or place on a counter or desktop
- Non-skid feet
- Can hold up to two earloop style face mask boxes, two tissues boxes or one box of gloves and a hand sanitizer bottle

Item #	Dimensions (W x H x D)	UPC
10383	G 15 x 8 <sup>1</sup> / <sub>4</sub> x 5 <sup>3</sup> / <sub>4</sub> "	063636103835



### Personal Protection Door Caddies

- Neatly store protective apparel supplies for easy access and retrieval
- Improves personal protection practices
- Conveniently holds gloves, masks, gowns, medical waste bags, hand sanitizers and other miscellaneous items on the door
- Keeps hallways free from supply cart congestion and eliminates violations of fire, logistics and regulatory codes
- Hangers adequately hold the weight of the caddy with contents and allow doors to close securely
- Material - Flame-retardant nylon
- Can be wiped clean with surface disinfectant

Item #	Capacity	Dimensions	UPC
17677	<b>A</b> 3 pockets, 3 glove pockets, space for signage	33 x 17	063636176778
17678	<b>B</b> 6 pockets, 3 glove pockets, space for signage	33 x 25	063636176785
17679	<b>C</b> 3 pockets, 3 glove pockets, space for signage, 2 large gown pockets on back	33 x 18 1/2	063636176792



### Aluminum Protective Apparel Organizer

- Holds up to four boxes of gloves, two boxes of face masks and also has a dispensing slot for gowns
- Hanging supply caddy is designed to mount to the wall using the keyhole mounts or hang on a door using the optional door hanger (#18310, sold separately) and provide quick access to supplies
- Aluminum organizer and hanger are painted grey, with a powerful antimicrobial paint that can simultaneously kill disease-causing bacteria, mold, fungi and viruses

Item #	Description	UPC
18309	<b>D</b> Aluminum Protection Organizer 26 3/4" W x 21" H x 4 1/2" D	063636183905
18310	Aluminum Door Hanger for 18309 5 1/2" W x 12 1/2" L	063636183103



### Personal Emergency Eyewash Stations

- Provides emergency care any time a person's eyes or face may have been exposed to corrosive, toxic, or caustic chemicals
- Ideal for use in proximity to work areas for immediate eye flushing until a larger, plumbed eyewash station can be reached
- #10076 includes a plastic holder, 32 oz (944mL) sterile isotonic eye wash station and 4 screws for mounting the station. Measures: 12 1/4" W x 14" H x 3" D
- #10077 – 32 oz (944mL) filled replacement bottles for #10076 eye wash station with easy-to-open screw top

Item #	Description	UPC
10076	<b>E</b> 32 oz. Emergency Eyewash Station	063636100766
18901	<b>F</b> 16 oz. Emergency Eyewash Station	063636189013
10077	32 oz. Filled Replacement Sterile Solution	063636100773

### Deluxe Safety Goggles

- Soft vinyl goggles with perforations for maximum ventilation
- Offers comfort and protection from flying particles, dust, and splash
- Fits comfortably even over large size prescription glasses
- Optical quality plastic lens

Item #	Description	UPC
35140	Deluxe Goggles	063636751401



### Deluxe Safety Goggles

- ChemoPlus protective wrap around goggles
- Durable plastic construction
- Splash-resistant
- One size fit - comfortable fits over most eyeglasses
- Ventilated - reduces chance of fogging
- Recommended for USP <797> compliance

Item #	Description	UPC
9630-01	Goggles	063636796303

### Latex Finger Cots

- Designed to protect fingers and fingertips from contaminants, as well protect finger dressings
- Includes assorted sizes (XS, S, M, L)

Item #	Qty	UPC
PS214	24	063636002145



### Multi-Cut Utility Shears

- Stainless steel blade, ideal for cutting bandages, dressing, fabric, or other tough material
- Colours available: ● black, ● blue, ● orange, ● pink, ● purple, ● red and ● yellow -specify when ordering

Item #	UPC
95-105	<b>A</b> 063636941956

### Handle Universal Scissors

- Stainless steel blade

Item #	Size	UPC
S3115	<b>B</b> 5 1/2"	063636831158

### Digital Thermometer, °C/°F

- For axillary or oral use only
- Large and easy to read liquid crystal display
- Fast and accurate - 10 seconds read time

Item #	Description	UPC
PS720 <b>A</b>	Flex Tip Digital Thermometer	063636007201
PS730 <b>B</b>	Digital Thermometer	063636007300

### Surgical Masks

- Lightweight and easy to use
- Elastic ear loops
- Pleated design for maximum comfort

Item #	Quantity	UPC
PS345 <b>C</b>	10	063636003456
B344	50	063636034405

### Universal Face Mask Box Holder

- Versatile - Securely holds a single box of face masks in a wide variety of sizes.
- Compatible - Works with boxes no larger than 8"W x 5½"H x 5½"D and no smaller than 6½"W x 4"H x 4½"D.
- Convenient - Can mount to most smooth surfaces using keyholes on the back.
- Material - Beige ABS plastic
- Dimensions - 8¼"W x 4"H x 5¼"D

Item #	UPC
20336 <b>D</b>	063636203368

### Reusable Face Mask

- 2 per package
- Material: Double layer fabric
- Not to be shared. Single person use only

Item #	Description	UPC
B341 <b>E</b>	Junior mask Size	300961043361

### Face Mask Ear Relief Bands

- 10/package
- Size: 8<sup>5</sup>/<sub>16</sub>"L x 1<sup>7</sup>/<sub>16</sub>"H

Item #	UPC
20445 <b>F</b>	063636204457



## PharmaSystems' Solutions for USP<797> Compliance: Sterile Preparations for Compounding Pharmacies

- USP chapter <797>, Sterile Preparations for Pharmaceutical Compounding, details the quality standards, conditions and procedures for compounding sterile preparations (CSPs) of drugs and nutrients in a cleanroom
- A cleanroom standard is enforced to prevent harm to patients that could result from microbial contamination, excessive bacterial endotoxins, variability in intended strength, unintended chemical and physical contaminants, and ingredients of inappropriate quality
- Cleanroom classes vary based on the nature of the operation, refer to the "compliance" below for product recommendations
- PharmaSystems® is proud to offer a range of cleanroom supplies to achieve and maintain USP <797> compliance, select from:
  - **Dry Wiping and Spill Control**
  - **Glove and Surface Cleaning**
  - **Isolator and Hood Cleaning**

### Amplitude™ Wipes

- **Use:** Ideal for spill kits and cleaning carts
- **Material:** Lightweight spunlaced cellulose/polyester
- **Features:** Economical option for general cleaning

Item #	Dimensions	Qty	UPC
18958	9 x 9"	300	063636189587



### EcoClean Wipes®

- **Compliance:** ISO Class 5 (class 100)**Use:** Designed for critical care units and cleanrooms
- **Material:** 100% natural fibre
- **Features:** Environmentally friendly – 100% biodegradable
- Low-linting, highly-absorbent, durable
- Heat-resistant, autoclavable
- Quarter-fold design promotes proper wiping technique

Item #	Dimensions	Qty	UPC
17883	5 x 5"	100 sheets	063636178833
17884	9 x 9"	300 sheets	063636178840
17885	12 x 12"	150 sheets	063636178857

### Lint-Free Wipes

- **Compliance:** USP <797> equipment cleaning guidance standards
- **Use:** Ideal for cleaning lab equipment and medical instruments
- **Features:** Lint-free – no traces of fibre or residue

Item #	Dimensions	Qty	UPC
18699	4 x 4"	300	063636186999
17509	9 x 9"	300	063636875091
17503	12 x 12"	150	063636175030



### Wipe Dispensers

- Ideal for patient rooms, labs and cleanrooms
- Clear PETG
- Available in countertop models with anti-slip bottoms, or wall-mount models to save valuable counter space (4 keyholes in back for mounting)

Item #	Description	Dimensions (W x H x D)	UPC
17886	<b>A</b> Countertop, 9 x 9" Wipes	9 <sup>5</sup> / <sub>8</sub> x 9 <sup>5</sup> / <sub>8</sub> x 3 <sup>7</sup> / <sub>8</sub> "	063636178864
17887	Countertop, 12 x 12" Wipes	12 <sup>5</sup> / <sub>8</sub> x 12 <sup>5</sup> / <sub>8</sub> x 3 <sup>7</sup> / <sub>8</sub> "	063636178871
17888	<b>B</b> Wall Mount, 9 x 9" Wipes	10 x 10 x 4 <sup>1</sup> / <sub>2</sub> "	063636178888
17889	Wall Mount, 12 x 12" Wipes	13 x 13 x 4 <sup>1</sup> / <sub>2</sub> "	063636178895

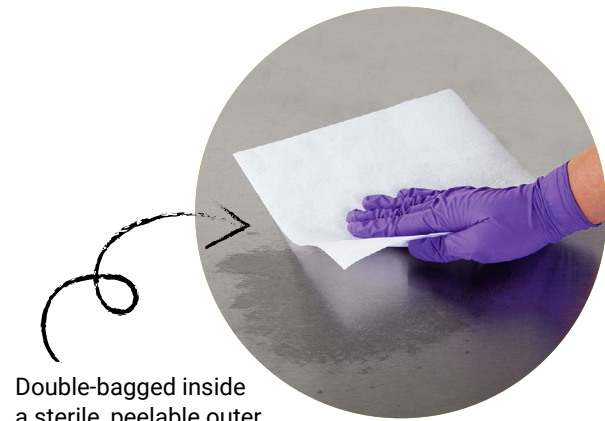
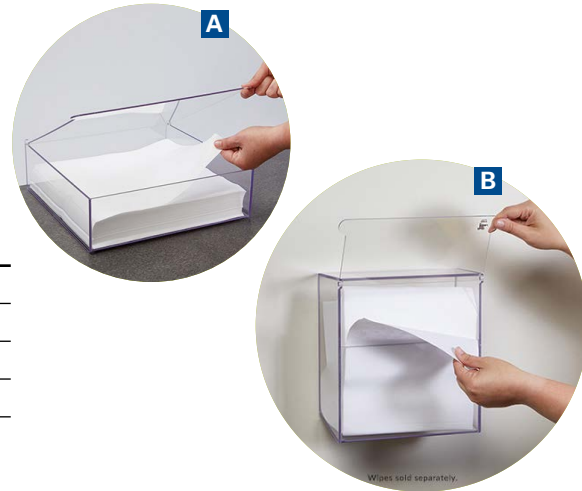

Double-bagged inside a sterile, peelable outer bag and linear tear inner bags, ready to introduce in cleanroom

### SterileSorb™ Wipes

- **Compliance:** ISO Class 5
- **Use:** Achieve USP <797> compliance
- Ideal for general purpose cleaning in critical environments: cleanrooms, labs, and compounding pharmacy areas
- **Material:** Nonwoven, cellulose/polyester
- **Features:** Sterile
- Extremely absorbent – low in extractable residues and particles for maximum efficiency in cleanroom settings
- Ideal choice for spill kit packaging

Item #	Dimensions	Qty	UPC
18956	9 x 9"	25	063636189563
18957	12 x 12"	25	063636189570



### Pro-Wipe® All-Purpose Low Linting Wiper, Perforated

- 250 sheets per pack; 4 packs per case
- Durable and low linting with highly absorbent cellulose core
- Excels at absorbency of water and oil based solutions
- **Material:** 50% Rayon 50% Polyester

Item #	Dimensions	UPC
17783	9 x 15"	063636177836

### Prosat® Presaturated Wipes

- **Compliance:** ISO Class 5 glove and surface cleaning
- **Use:** Ideal for use in critical healthcare areas: benches, hoods and equipment, as well as instruments and other articles prior to pass through
- **Material:** Non-woven, polypropylene
- **Active ingredients:** Isopropyl alcohol 70%, deionized water 30%
- **Features:** Sterile
- Resealable pouches with tamper-evident labels



Item #	Dimensions	Qty	UPC
18713	9 x 11"	30	063636187132



### Presaturated Cleanroom Wipers

- **Compliance:** ISO Class 5 and above
- **Use:** Ideal for general-purpose cleaning, surface preparation or wipe down of articles during pass-through. Also effective for residue removal after detergent or disinfectant use
- **Material:** Non-woven, cellulose/polyester
- **Saturated with:** 70% semiconductor grade isopropyl alcohol (IPA) and 30% deionized water (DI)
- **Features:** Ensures consistent saturation and improved control of cleaning protocols
- Excellent strength and durability
- Higher saturation level to support critical solution contact time needed
- Peel and reseal pouches allow for single-wipe use and prevents solvent evaporation
- Lot number printed on each package for traceability and process accountability

Item #	Dimensions	Qty	UPC
17880	9 x 9"	75	063636178802

### Sterile Alcohol Spray Bottles

- **Compliance:** ISO Class 5 glove and surface cleaning
- **Use:** Wipedown of isolators, cabinets, laminar flow hoods and surfaces
- Use on gloved hands in sterile suites
- Wipe down of products and equipment for pass through to controlled environments
- Ideally suited for use with sterile cleanroom wipes
- **Active ingredients:** 70% by volume USP Grade Isopropanol (IPA) and 30% USP Grade Purified Water, filtered to 0.2µ
- **Features:** sterile alcohol spray, induction sealed to assure stability

Item #	Description	Capacity	UPC
17979	<b>A</b> Sterile alcohol spray bottle	16 oz.	063636179793
18627	Sterile alcohol spray bottle	32 oz.	063636186272
20254	<b>B</b> Sterile Isopropanol Alcohol, Flip-Top	16 oz	063636179786



### EasyReach™ Stainless Steel Cleaning Tool

- Achieve quick, effective, one-handed cleaning and disinfecting in critical areas where USP <797> compliance has been mandated
- Single piece stainless steel tool is easily passed through transfer hatches, requires no assembly and is maintenance-free
- Versatile low profile, 360 degree pivoting head ensures even the most awkward areas can be quickly reached with ease
- All components are chemical resistant, minimizing the risk of contamination from degradation
- Made from lightweight stainless steel
- Dimensions of cleaning tool: 17"L (432mm)

**Applications:** EasyReach™ is recommended for effective cleaning and disinfection of surfaces in:

- Isolators - rigid, flexible film, half suits
- Restricted Access Barrier Systems (RABS)
- Filling Lines
- Laminar Air Flow Hoods
- Bio-Safety Cabinets
- Glove boxes
- Incubators
- Clean air hoods

Item #	Description	Qty	UPC
18273	EasyReach™ Stainless Steel Cleaning Tool	1	063636182731
18274	Quilted Polyester Cleaning Pads	60/pack (15 bags of 4 wipes)	063636182748
18275	Sterile Quilted Polyester Cleaning Pads	60/pack (15 bags of 4 wipes)	063636182755
18276	Sterile Presaturated Cleaning Pads 70% IPA	64/pack (8 bags of 8 wipes)	063636182762

### Wipes

- Cleaning Pads have a specially designed tab for quick, easy fitting to the 7" mophead frame with gloved hands
- Pads are available in three styles: regular, sterile, and sterile presaturated
- The well-fitted quilted polyester pad ensures effective, even surface coverage reducing the number of viable and non-viable contaminants and ensuring maximum residue removal
- Double bagged, laundered, validated sterile, single-use cleaning pads ensure no burden is added to the critical environment
- Presaturated EasyReach™ Cleaning Pads eliminate the need for 70% IPA spray, minimizing transfer of materials and simplifying cleaning procedures.



### EasyClean® 360 Isolator Cleaning Tool & Covers

- Ideal for efficient cleaning in areas where USP <797> compliance has been mandated such as compounding isolators, biological safety cabinets, laminar flow hoods and other controlled hospital pharmacy environments critical to the quality and purity of compounded products
- Compact with a durable stainless steel mop head that swivels 360° for easy maneuverability in tight spaces
- Includes 14" and 24" lightweight anodized aluminum handles, and features a quick-connect mechanism for easy attachment after pass through
- Mop head handles can be sterilized by autoclave or gamma radiation

Item #	Description	UPC
18708	EasyClean® 360 Isolator Cleaning Tool	063636187088
18709	Non-Sterile Mop Head Covers 25 disposable covers & 1 padded cover	063636187095
18710	Sterile Mop Head Covers 10 disposable covers & 1 padded cover	063636187101



### Cleanroom & Floor Marking Tape

- Construction - 2" wide polyester vinyl with rubber adhesive.
- Improve Visibility - Striped floor marking tape can help designate critical areas such as entry to cleanrooms, isolation areas, cart storage, etc. Adheres well to all surfaces.
- Options - Available with OSHA standard warning striped colors: Black/Yellow stripe and Red/White stripe. Specify color when ordering.
- Packaging - 18 yards per roll, 3 rolls per package (54 yards total)

Item #	Qty	UPC
18658	3	063636186586



### Peel Away Dirt & Dust Control Mats

- Construction - Designed with multiple sheets. When top sheet is contaminated, pull it off and discard.
- Prevent Contamination - Tacky surface pulls dirt and dust off shoes before they can contaminate a cleanroom.
- Packaging - 30 sheets per mat, 4 mats per package (120 sheets total)

Item #	Size	UPC
17736	36 x 18"	063636177362
7384	45 x 18"	063636773847
17738	36 x 24"	063636177386
17737	45 x 24"	063636177379
17739	45 x 36"	063636177393

### Tacky Mats

- Construction: 2-mil thick sheets have adhesive coating with antimicrobial germicide that covers the full area of the mat
- Ready to use: mats remove dirt, dust and lint on contact from shoes
- Quantity: 30 sheets per mat; 4 mats per package; 120 sheets total
- Tab system helps remove top layer

Item #	Size	UPC
5601-01	34 x 18"	063636756017
5602-01	45 1/2 x 18"	063636756024
5603-01	24 x 34"	063636756031
5605-01	46 x 36"	063636756055
5606-01	60 x 36"	063636756062

### Pre-op Mitt

- Convenient infection prevention mitt properly prepares a patient for surgery
- Adhesive palm picks up loose hairs and other foreign matter, providing a clean surgical field
- One size fits most

Item #	Measures	Qty	UPC
7441-01	7 x 5.5"	100	063636744106



### Personalized Namebadge

- Professional, easy to read pins
- Ideal for pharmacists, pharmacy technicians, assistants, and retail staff
- Includes pin back and magnetic back
- Can be personalized up to 3 lines, 30 characters per line
- Dimensions: 3" W x 3/4" H

Item #	Description	Qty	UPC
Q116	<b>A</b> Rx	1	063636117887
Q117	<b>B</b> Mortar and Pestle	1	063636117870



Giftware



### Baby Rx Booties

- Elastic ankle bands provide a just-right fit and keep toes cozy
- Contrasting RX logo is stitched inside heart
- Includes 2 sets of baby booties; 1 red and 1 white pair

Item #	Description	Qty	UPC
Y120	Booties	2 pairs	063636211202



### Glass Coffee Mugs, Rx Symbol, 10 oz

- Boxed Set of 4
- 10 oz. glass with distinctive mortar and pestle and Rx logo etched onto the glass.

Item #	UPC
C532	063636253202



### Pharmacy Wine Glasses

- Set of 4
- 10.5 oz wine glasses
- Etched with pharmacy design
- Comes gift boxed.

Item #	UPC (063636)
H098	063636808914

### Crystal Key Chain with Mortar and Pestle

- Mortar & Pestle 3-D image inside the crystal with unsurpassed craftsmanship. The perfect gift or recognition item they'll remember all the time!
- 3/4"W x 1 1/4"H

Item #	UPC
12711	063636127114



### Rx Key Chain

- Traditional design and silver accents give this key chain instant appeal while woven Rx design on blue fabric adds personality
- 4"

Item #	UPC
CC100	063636001001

### Female Pharmacist Steel Sculpture Cardholder

- Recycled steel has been sculptured into a cardholder to provide a unique display stand for the female pharmacy professional's business cards. Each sculpture contains indigenous markings that showcase its originality.

Item #	UPC
18795	063636187958



### Rosewood Pen Set, Personalized

- One ball point pen and one roller ball pen tuck neatly into the case
- Case can be personalized with logo and up to 2 lines of up to 30 characters per line including spaces
- Pens personalized with 1 line of up to 24 characters including spaces

Item #	UPC
Q166	063636011666

### Super Hero Badge Reel Cover

- Ordinary ID badges get a fresh new look with interchangeable, professional-themed Badge Reel Covers that attach to matching Badge Reels (sold separately) with Velcro®
- Choose from two lanyard patterns (sold separately) to complete your badge makeover

Item #	Description	UPC
G309	<b>A</b> Super hero Badge	063636003098
G306	<b>B</b> Lanyard, black & white	063636003067



# PILL SPLITTER

## CUSTOM IMPRINT ORDER FORM

### PILL & TABLET SPLITTER

ITEM NO. IMP7345

PRICE: \$4.50/each

#### 1. INPUT QUANTITY (MOQ: 500 Units)

\_\_\_\_\_ Units

#### 2. SELECT INK COLOUR

Blue  Red  Green  Black  White

#### 3. IMPRINT INFORMATION (UP TO 3 LINES & 30 CHARACTERS PER LINE) OR SUBMIT COMPANY LOGO (VECTOR IMAGE ONLY)



Special pricing available for larger quantities upon request. Please contact customer service for pricing.

**Please Note: A \$5.00 plate & set-up fee will be added to new imprint orders.**

Email or fax completed order form to [orders@pharmasystems.com](mailto:orders@pharmasystems.com) | 1.888.475.7155

Pharmacy: _____		Name: _____	
Address: _____		Phone: _____	
City: _____		Fax: _____	
Province: _____	Postal Code: _____	Email: _____	
Date: _____	Wholesaler: _____	Account No.: _____	

# COUNTING TRAY

## CUSTOM IMPRINT ORDER FORM

### PILL & TABLET COUNTING TRAY W/SPATULA

ITEM NO. IMPD-50

PRICE: \$14.50/each

#### 1. INPUT QUANTITY (MOQ: 500 Units)

\_\_\_\_\_ Units

#### 2. SELECT INK COLOUR

Blue  Red  Green  Black  White

#### 3. IMPRINT INFORMATION (UP TO 3 LINES & 30 CHARACTERS PER LINE) OR SUBMIT COMPANY LOGO (VECTOR IMAGE ONLY)



Special pricing available for larger quantities. Contact customer service for pricing.

**Please Note: A \$5.00 plate & set-up fee will be added to new imprint orders.**

Email or fax completed order form to [orders@pharmasystems.com](mailto:orders@pharmasystems.com) | 1.888.475.7155

Pharmacy: _____		Name: _____	
Address: _____		Phone: _____	
City: _____		Fax: _____	
Province: _____	Postal Code: _____	Email: _____	
Date: _____	Wholesaler: _____	Account No.: _____	

# ORAL DISPENSERS

## CUSTOM IMPRINT ORDER FORM

### 1. SELECT ITEM

ITEM NO.	DESCRIPTION	PRICE
<input type="checkbox"/> Item # IMP205	5 ml Clear Oral Dispensers	\$0.90/each
<input type="checkbox"/> Item # IMP210	10 ml Clear Oral Dispensers	\$0.85/each
<input type="checkbox"/> Item # IMP200	10 ml Clear Oral Dispensers w/tube (Flow Wrapped)	\$1.25/each
<input type="checkbox"/> Item # IMP205PSW	5 ml White Oral Dispensers	\$0.90/each

### 2. INPUT QUANTITY (MOQ: 500 Units)

\_\_\_\_\_ Units

### 3. SELECT INK COLOUR

Blue  Red  Green  Black

### 4. IMPRINT INFORMATION (UP TO 3 LINES & 30 CHARACTERS PER LINE)

Special pricing available for larger quantities upon request. Please contact customer service for pricing.

**Please Note: A \$5.00 plate & set-up fee will be added to new imprint orders.**

Email or fax completed order form to [orders@pharmasystems.com](mailto:orders@pharmasystems.com) | 1.888.475.7155

<b>Pharmacy:</b>	<b>Name:</b>
<b>Address:</b>	<b>Phone:</b>
<b>City:</b>	<b>Fax:</b>
<b>Province:</b> <b>Postal Code:</b>	<b>Email:</b>
<b>Date:</b>	<b>Wholesaler:</b> <b>Account No.:</b>

## New Pharmacy Recommendations

The following are our recommendations for new pharmacy opening orders. Contact our customer service department for more information and details about your province's College of Pharmacy requirements, and for required reference books.

### Starter Package | Item # ORD1

Item #	Item Description
2998	Filter paper
3002	Graduated glass cylinder 10ml
3006	Graduated glass cylinder 50ml
3008	Graduated glass cylinder 100ml
3016	Weighing paper
3017	Glass stirring rods 8" (3)
3091	Spatula rubber 4"
3042	Spatula stainless steel 4"
3028	Spatula stainless steel 6"
3029	Spatula stainless steel 8"
3030	Funnel (Plastic 55 mm) 2"
3031	Funnel (Plastic 100 mm) 4"
3073	Mortar & Pestle Glass Set 4 oz
3075	Mortar & Pestle Glass Set 8 oz
3076	Mortar Glass 16 oz
3086	Pestle Glass 16 oz
3088	Ointment Pad
3090	Weighing boats plastic 100/pkg
VIC-303	EJ Series Electronic Scale, 300 gram capacity
CAL200	200g Calibration Weight
17751	Traceable® Temperature Recorder - Jumbo Display

### Deluxe Package | Item # ORD2 (includes items from ORD1)

Item #	Item Description
20050-12	Bottles Amber Glass, 50 ml 264/Case
200100	Bottles Amber Glass 100 ml 70/Case
200200	Bottles Amber Glass 250 ml 96/Case
200500	Bottles Amber Glass 500 ml 48/Case
2001000-01	Bottle Amber Glass 1L
20020	White Lined Caps, 100/Pkg (For #20050-12 & 200100)
20022	White Lined Caps, 150/Pkg (For #200200)
20024	White Lined Caps, 55/Pkg (For # 200500)
20026	White Lined Caps, 25/Pkg (For #2001000)
3014	Glass Graduated Cylinder, 250 ml
3015	Glass Graduated Cylinder, 500 ml
3371	Glass Graduated Cylinder, 1000 ml
3098	Glass Ointment Slab, 12 X 12", 1/4" Thick
7782	7 MI Sterile Dropper Bottles With Dropper Caps, 12/Case
7784	15 MI Sterile Dropper Bottles With Dropper Caps, 12/Case
D-50	Tablet Counting Tray And Spatula
BK-40	Warning Label System & 17 Labels
T1-1	Tape Rx 1" X 36 Yds., 1" Core
T1-3	Tape Rx 1" X 72 Yds., 3" Core
Td1	Tape Dispenser For 1" Wide Tape (1" And 3" Core)
PRP-3	Rx Receipts 100/Pad x 10 Pads
11194	Small Box For Rx Prescription Pads (Each)
10196	Large Box For Rx Prescription Pads (Each)
1976	Rx Prescription Pad File Folder (Double Fold), 100/Pk
5272	Anti-Fatigue Mat Ribbed Grey, 3' x 5'

**Item Number:**      **Qty:**

**ORD1**     

**ORD2 (includes items from ORD1)**

Fax or Email Completed Order Form: 1.888.475.7155 | [orders@pharmasystems.com](mailto:orders@pharmasystems.com)

<b>Pharmacy:</b>	<b>Name:</b>
<b>Address:</b>	<b>Phone:</b>
<b>City:</b>	<b>Fax:</b>
<b>Province:</b> <b>Postal Code:</b>	<b>Email:</b>
<b>Date:</b>	<b>Wholesaler:</b> <b>Account No.:</b>

# Methadone Dispensing Supplies

Item #	Description	Order Qty
<b>Dispensettes</b>		
DK107-13	Analog Dispensette, 0.5-5 mL   Measures increments of 0.1 mL	
DK107-33	Digital Dispensette, 0.5-5 mL   Measures increments of 0.02 mL	
DK107-10	Analog Dispensette, 1-10 mL   Measures increments of 0.2 mL	
DK107-30	Digital Dispensette, 1-10 mL   Measures increments of 0.05 mL	
DK107-50	Digital Dispensette, 10-25 mL   Measures increments of 0.1 mL	
DK107-32	Analog Dispensette, 10-25 mL   Measures increments of 0.5 mL	
DK107-16	Analog Dispensette, 5-50 mL   Measures increments of 1 mL	
DK107-36	Digital Dispensette, 5-50 mL   Measures increments of 0.2 mL	
DK-201	Dispensette Extended Filling Tube for use with bottles 1L or greater for DK107-13, DK107-33, DK107-10, DK107-30	
DK-205	Dispensette Extended Filling Tube for use with bottles 1L or greater for DK107-32, DK107-16, DK107-50, DK107-36	
<b>Bottles</b>		
200100	100 mL Amber Glass Bottles, 140/case	
10289	100 mL Amber Plastic Bottles without caps, 108/case	
10294	Tamper Resistant Caps 250 per case, for Amber Plastic Bottles	
2001000-01	1L Amber Glass Medicine Bottle (1)	
<b>Dispensing Accessories</b>		
7362	2 oz. Plastic Cups, with Graduations, 1000/case	
7360	3.5 oz. Plastic Cups, 100/case	
7361	5 oz. Plastic Cups, 50/case	
10203	3 mL Clear Oral Dispensers with tips, 100/case	
10205	5 mL Clear Oral Dispensers with tips, 100/case	
10210	10 mL Clear Oral Dispensers with tips, 100/case	
P-2	Methadone Label, 2 rolls of 500 per box	
1634AA-250	Glass Graduated Cylinder 250 mL, Class A Cylinder	
12281	Tamper Evident Tape Strips, 100/box	
8000	Red Tamper Resistant Tape, 1/2" wide, 108 ft. long	
8006	Red Tamper Resistant Tape, 1" wide, 108 ft. long	



Methadone may cause serious harm to someone other than the intended patient. Not to be used by anyone other than the patient for whom it was intended. MAY BE FATAL TO CHILD OR ADULT

Dispensettes are accurate to 0.5% of over all volumes  
 ISO/GLP compliant  
 1 year warranty and 100% guarantee against product defects  
 Includes: adjustable filling tube, recirculation tube, adapters, discharge tube and digital housing units

<b>A</b>	
Adapta-Cap	87
Add-Port Cap, Tamper Resistant	90
AkroBins, Super-sized	36
Alcohol Spray Bottles, Sterile	167
Alert Void Security Bags	81
All Metal Tablet Crusher	116
Amber Zip It Bags	68
Ambidextrous Tablet Counter	33
Amplitude Wipes	165
Ampule Breaker	91, 111, 156
Ampule Crackers	91
Ampule Opener	91
Anti-Fatigue Matting	105
Anti-Microbial Matting	106
Anti-Static Weighing Canoes	10
Apothecary Weight Set	9
Automated Pill Crusher	115
<b>B</b>	
Bag, Insulin Pen	79
Bags, Alert Void Security	81
Bags, Amber Zip It	68
Bags, Biohazard	77, 78, 157
Bags, Chemobloc Safelock Drug Transport	78
Bags, Chemotherapy Disposal	78, 158
Bags, Chemo Waste	77
Bags, Chemo Wipe	77
Bags, Clear Zip It	66
Bags, Evidence/Chain of Custody	81
Bags, Full-Size Crash Cart Boxes	124
Bags, Hanging Prescription	76, 112
Bags, Leakproof Chemo	79
Bags, Message Colour-Coded	73
Bags, Patient	72
Bags, Patient's Medicine Inventory	81
Bags, Patient Valuables	81
Bags, Personal Property	81
Bags, Poly	68
Bags, Prescription	110
Bags, Security	124
Bags, Self-Sealing Tamper Indicating	73
Bags, Standard Security	81
Bags, Tamper Evident	80, 81
Bags, UVLI	70

Bag with Pouch	72
Baskets, Mesh	46
Baxa ExactaMed Oral Dispensers	83
Beakers, Glass	14
Beakers, Stainless Steel	14, 15
Beard Guards	160
Bell & Conical Glass Cylinders	12
Bin Cups	37
Bin, High Alert Insulin	47
Bins, Cassettes	41
Bin, Shelf Dividers	37
Bins, Shelf	37
Bins, Super-sized AkroBins	36
Bins, Super Tough	35
Bins, Tilters Tilt Front	46
Bin, Store-Max	45
Bins, Waterloo Locking Cassettes	40
Biohazard Bags	157
Biohazard Sharps Disposal Containers	155
Biohazard Specimen Bags	78
Biohazard Waste Bags	77
Biohazard Zip It Bags	78
Biohazard Zip-It Bag with Pouch	79
Blister Blocks, Foam Sealing Tray	98
Blister Foam Sealing Trays	101
Blisters, Class A	99
Blisters, Class A Round	101
Blisters, Foam Sealing Tray	100
Blisters, Rollers	101
Bottle Adapters	82, 84
Bottle Adapter, Universal	87
Bottle, Nasal Spray	31
Bottle, Wash	31
Boxes, Crash Cart	120
Boxes, Divider	42
Boxes, Emergency	50
Boxes, Flip Top	43
Boxes, Insulated	51, 136
Boxes, Prescription	114
Boxes, Refrigerator	133, 134
Boxes, Refrigerator Storage	133
Boxes, Tote	43
Boxes, Transfer	44
Box, Medical Supply	48
Briefcase Drug Boxes	52

<b>C</b>	
Cabinets, Narcotic	62, 64
Calibrated Dropper and Vial	26
Calibrated Window Vials	26
Calibration Weights	9
Cardboard Shelf Caddies	39
Carts	120
Cassettes	41
Chairs, Kango Polyurethane	108
Chemobloc Safelock Drug Transport Bags	78, 157
Chemo Leakproof Bags	79
Chemo Prep Mats	158
ChemoSafety Sharps Disposal Containers	155
ChemoSorb Pad	158
Chemotherapy Disposal Bags	78, 158
Chemotherapy Transport Bags	77, 158
Chemo-Vent Filtered Venting Needle	90
Chemo Waste Bags	77
Chemo Wipe Bags	77
Citrus Adhesive Remover	148
Class A Amber Blisters	99
Class A Condensed Blisters & Micro Blisters	100
Class A Labels for Blisters	98, 100
Class A Laser Labels for Round Blisters	101
Class A Round Blisters	101
Clear bag with pouch	72
Clear Plastic Graduated Cylinders	12
Clear Sterile Glass Bottles	28
Clear Zip It Bags	66
Colour-Coded Message Bags	73
Complete Comfort Mat	108
Containers and Accessories	21
Counters, Tablet	33, 110
Crash Cart Bags	73, 124
Crash Cart Boxes	120
Crusher, Automated	115
Crusher Bag, Easy Empty	117
Crusher, Pill	117
Crusher Pouches, Tablet	69
Crusher, Quiet	116
Cup, Medication Transport Tray	119
Cups, Medication Crushing/Cutting	119
Cups, Paper	118
Cups, Plastic	118
Cups, Wax Paper	119

Index

Fax or Email Completed Order Form: 1.888.475.7155 | orders@pharmasystems.com

<b>Pharmacy:</b>	<b>Name:</b>
<b>Address:</b>	<b>Phone:</b>
<b>City:</b>	<b>Fax:</b>
<b>Province:</b>	<b>Email:</b>
<b>Date:</b>	<b>Wholesaler:</b>
<b>Postal Code:</b>	<b>Account No.:</b>

Cylinders, Bell & Conical	12
Cylinders, Graduated	11, 12
CytoSafe Dispensing Pin	89
<b>D</b>	
Datalogging Thermometers	129, 131
Deluxe Anti-Microbial Tile Top Matting	106
Dispensers, Wipe	166
Dispensette III	22
Dispensing Containers and Accessories	21
Dispensing Pins	89
Disposable Ampule Breaker	111
Dissolve-A-Dose	86
Divider Boxes	42
Dividers, Shelf Bins	37
Dividers, Waterloo Locking Cassettes	40
Drawer Organizing Trays	47
Dropper and Vial	26
Drug Boxes, Briefcase	52
Drug Transport Bags	78, 157
Dual Action Vial Decappers	27
<b>E</b>	
Ear Relief Bands	164
Easy Empty Crusher Bag	117
Easy Read Vial Stands and Grippers	31
EcoClean Wipes	165
Emergency Boxes	50
Emergency Eyewash Stations	162
Envelope, Medication	34
Ergonomic Tablet Counters	33, 110
Erlenmeyer Flasks	16
Evidence/Chain of Custody Bags	81
ExactaMed Dispensing Pin	89
Extra Heavy Duty Pull Tight Seals 55	
<b>F</b>	
Face Mask Box Holder	164
Face Mask Ear Relief Bands	164
Flasks	16
Flip Top Boxes	43
Flip Top Sharps Container	156
Fluid Transfer Tube Set	92
Foam Sealing Trays	98, 100, 101
Forceps	112
Freestanding Refrigerators	132
Fretwell's Triangle	33, 110

Funnels, Glass	16
Funnels, Plastic	16
<b>G</b>	
Glass Beakers	14
Glass Cylinders, Bell & Conical	12
Glass Eye Dropper & Bottle	26
Glass Funnels, Heavy Duty	16
Glass Stirring Rods	15
Glove Box Holders	161
Goggles & Safety Glasses	163
Gowns	160
Graduated Cylinders	11, 12
Graduated Cylinders, Plastic	12
<b>H</b>	
Hanging Prescription Bags	76, 112
Heat Sealers	69
Heavy Duty Glass Funnels	16
Heavy Duty Pull Tight Seals	55
High Alert Insulin Bin	47
Hinged Lid Transfer Boxes	44
<b>I</b>	
Infection Control Poly Bags	76
Insulated Boxes	51, 136
Insulin Pen Bag	79
IV Bag Belly Button Port Seal, Steri-Tamp	57
IV Bag Port Seals, Steri-Tamp	57
IV Covers & Bags	71
<b>J</b>	
Jars, Ointment	21
<b>K</b>	
Kango Polyurethane Chairs	108
Kango Stand-Up Seat	109
Kwik-Vial	92
Kwik-Vial, Plug Dispenser	93
<b>L</b>	
Labcoats	160
Label Dispensers	149, 150
Labels, Dietary Information	138
Labels, Dosing Frequency	138
Labels, Dosing Information	141, 142
Labels, Expiration Discard	138
Labels for Blisters, Class A	98, 100
Labels, Months	148
Labels, Patient Privacy	150
Labels, Refill Information	143
Labels, Route of Administration	137

Labels, Storage Information	141
Labels, Warning	139
Labels, Weekday Auxiliary	148
Leakproof Chemo Bags	79
Leaktight Sharps Containers	156
Lockable Storage Cabinet	65
Locking Cassettes	40
Locking Key Storage Boxes	64
Locking Refrigerator Boxes	134
Locking Tip Cap	87
Locking Wall Box with Digital Lock	42
Luer Lock Connector, Sterile Female-Female	85, 86
Luer-Lock Syringe Caps, Sterile	86
Luer Lock Tip Caps	85
Luer Lock-to-Catheter Tip Adapter	88
Luer Lock-to-Oral Slip Connector	88
Luer Lock Universal Spike, Sterile	88
<b>M</b>	
Mask, Reusable	164
Masks, Surgical	164
Mat, Complete Comfort	108
Mats, Chemo Prep	158
Mats, Peel Away Dirt & Dust Control	107
Mats, Tacky	107
Matting	105
Medical Supply Box	48
Medication Crushing/Cutting Cups	119
Medication Cup Transport Tray	119
Medication Envelope	34
Medicine Vials	29
Mesh Baskets	46
Message Bags, Colour-Coded	73
Metered Pump Nasal Spray Bottle	31
Methadone Dispensing Supplies, Order Form	176
Metro Lifeline Crash Cart Boxes	120
Metro Utility Cart	120
MonitorMark Product Exposure Indicator	136
MT Unit-Dose Packaging	10
Mugs	170
Multi-Cut Utility Shears	112, 163
<b>N</b>	
Namebadge, Personalized	170
Narcotic Cabinets	62, 64
Narcotic Locker, Double Door	62
Nasal Spray Bottle, Metered Pump	31

Needle, Spiked	90
Needles, Two-Fer	89
Needle, Venting	89, 90
Nest and Stack Totes and Lids	45
New Pharmacy Recommendations, Order Form	175
Non Reclosable Poly Bags	68
<b>O</b>	
Octagonal Stir Bars	10
Ointment Jars	21
Ointment Tubes	20
Oral Dispensers, Amber	83
Oral Dispensers, Baxa	83
Order Form, Methadone Dispensing Supplies	176
Order Form, New Pharmacy Recommendations	175
<b>P</b>	
Padlock Seals	54
Paper Cups	118
Patient Bags	72
Patient's Medicine Inventory Bags	81
Patient Valuables Bags	81
Peel Away Dirt & Dust Control Mats	107
Personalized Namebadge	170
Personal Property Bags	81
Personal Protection Door Caddies	162
pH Test Papers	17
Pill Crusher	117
Pill Crusher, Automated	115
Pill Crusher, Ultimate	117
Pill & Tablet Splitters	117
Plastic Cups	118
Plastic Floor Stock Cassettes	41
Plastic Funnels	16
Plastic Graduated Cylinders	12
Plastic Stirring Rods	15
Plastic Utility Boxes	50
Plastic Weighing Boats	10
Plug Dispenser, Kwik-Vial	93
Pockets, Self-Adhesive	48
Poly Bags	68
Poly Bags, Infection Control	76
Poly Bags, Non Reclosable	68
Pre-Printed Messages, Syringe Seals	61, 83
Pre-Printed Messages, Tamper Seals	87
Pre-Printed, Tamper Evident Seals	58

Presaturated Wipes	167
Prescription Bags	110
Prescription Bags, Hanging	112
Prescription Bags, Wall Rack	76, 112
Prescription Boxes	114
Prescription Hanging Bags	76, 112
Prescription Receipt Pads	113
Press-In Bottle Adapters	82, 84
Protective Apparel Organizer	162
Pull Tight Padlock Seals	54
Pull Tight Seals, Small	53
Pull Tight Security Seals, Emergency	53
<b>Q</b>	
Quiet Crusher	116
<b>R</b>	
Racks, Test Tube	34
Rapid Fill Connectors, Sterile	88
Refrigerate Zippit Bag	135
Refrigerator Boxes	133, 134
Refrigerator Boxes, Locking	134
Refrigerator Boxes, Tape	133
Refrigerator, Freestanding	132
Refrigerators, Freestanding	132
Refrigerator Storage Boxes	133
Reusable Face Mask	164
Ribbed Anti-Fatigue Matting	105
Ring Pull Seals	54
Rollers for Round Blisters	101
Rubbermaid Utility Cart	120
Rubber Spatulas	18
Rx Fill Tray	47
Rx Tape	113
<b>S</b>	
Safety Control Seals	54
Scales	8
Scissors, Handle Universal	112, 163
Sealers, Heat	69
Seals, Extra Heavy Duty Pull Tight	55
Seals, Heavy Duty Pull Tight	55
Seals, Padlock	54
Seals, Ring Pull	54
Seals, Small Pull Tight	53
Seals, Tamper Indicating	59, 60
Seals, Twin Tote	56
Seals, Vial	57
Seal, Syringes	61

Security Bags	124
Security Bags, Full-Size Crash Cart Boxes	124
Security Seals, Pull Tight	53
Self-Adhesive Pockets	48
Self-Sealing Tamper Indicating Bags	73
Sharps Containers	155, 156
Shelf Bins	37
Shelf Bins, Bin Cups	37
Shoe Covers, Plastic	160
Spatulas, Rubber	18
Spatulas, Stainless Steel	18
Spatula with Multi-Purpose Tool	18
Spiked Plastic Fill Needle	90
Splitters, Pill & Tablet	117
Spray Bottle, Nasal	31
Stainless Steel Beakers	14
Stainless Steel Locking Refrigerator Storage Boxes	133
Stainless Steel Trays	34, 45, 111
Standard Security Bags	81
Stand-Up Seat, Kango	109
StaySafe™ Self-Sealing Bottle Closure	84
Sterile Alcohol Spray Bottles	167
Sterile Amber Glass Eye Dropper & Bottle	26
Sterile Female-Female Luer Lock Connector	85, 86
Sterile Luer-Lock Syringe Caps	86
Sterile Luer Lock Universal Spike	88
Sterile Rapid Fill Connectors	88
SteriSorb Wipes	166
Steri-Tamp IV Bag Belly Button Port Seal	57
Steri-Tamp IV Bag Port Seals	57
Steri-Tamp Sterile Tamper Evident Seals	57, 63, 66
Steri-Tamp Syringe Seal	61
Stir Bar Retriever	15
Stir Bars, Octagonal	10
Stirring Rods, Glass	15
Stirring Rods, Plastic	15
Storage Boxes, Locking Key	64
Storage Cabinet, Lockable	65
Store-Max High Bin	45
Store Totes with Lids	44
Super-Sized AkroBins	36
Super Tough Bins & Lids	35

Surgical Masks	164
Syringe Caps, Luer-Lock	86
Syringe Seals	61
Syringe Seals, Pre-Printed Messages	61, 83
Syringe Seal, Steri-Tamp	61
<b>T</b>	
Tablet Counters	33, 110
Tablet Crusher, All Metal	116
Tablet Crusher Pouches	69
Tacky Mats	107
Tamper Evident Bags	80, 81
Tamper Evident Seals, Steri-Tamp Sterile	57, 63, 66
Tamper Evident Seals with Pre-Printed Messages	58
Tamper Evident Syringe Seals Pre-Printed Messages	61, 83
Tamper Evident Tape Strips	60
Tamper Indicating Bags, Self-Sealin	73
Tamper Indicating Seals	59, 60
Tamper Resistant Add-Port Cap	90
Tamper Resistant Tape	6, 60
Tamper Seals, Pre-Printed Messages	87
Tape Dispensers	113
Tape for Refrigerator Boxes	133
Tape, Rx	113
Tape Strips, Tamper Evident	60
Tape, Tamper Resistant	6, 60
Test Tube Racks	34
Thermometers	128, 129, 130
Tilters Tilt Front Bins	46
Tip Cap, Locking	87
Tip Caps, Luer Lock	85
Tongue Depressors	114
Tote Boxes	43
Transfer Boxes, Hinged Lid	44
Transport Bags, Chemotherapy	77
Tray, Rx	47
Trays, Organizing Drawer	47
Trays, Stainless Steel	34, 45, 111
Tubes, Ointment	20
Twin Tote Seals	56
Two-Fer Needles	89

<b>U</b>	
Ultimate Pill Crusher	117
Unit-Dose Packaging	10
Universal Bottle Adapter	87
Universal Handle Scissors	112, 163
Utility Boxes, Plastic	50
Utility Carts	120
Utility Shears, Multi-Cut	112, 163
UVLI Bags	70
<b>V</b>	
Venting Needle	89, 90
Vial & Dropper, Calibrated	26
Vials, Medicine	29
Vial Stands and Grippers	31
Vials, Window	26
Volumetric Flasks	16
<b>W</b>	
Wall Rack for Prescription Bags	76, 112
Wash Bottle	31
Waterloo Locking Cassettes	40
Wax Paper Cups	119
Weighing Boats, Plastic	10
Weighing Canoes, Anti-Static	10
Weights, Calibration	9
Weight Set, Apothecary	9
Wine Glasses	170
Wipe Dispensers	166
Wipes	165, 167
<b>Z</b>	
Zip It Bags, Amber	68
Zip It Bags, Clear	66
Zip It, Biohazard Bags	78
Zippit Bag, Refrigerate	135